

OFFICE CHAIR ASSEMBLY INSTRUCTION

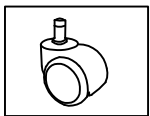

THANK YOU FOR PURCHASING OFFICE CHAIR

PARTS LIST



A 5×Wheels

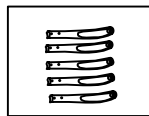

B1 5×Split base tube

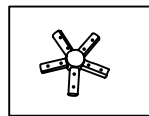

B2 1×Central
base tube

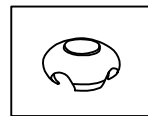

B3 1×base cover

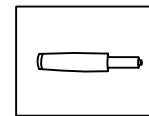

C1 1×gas lift

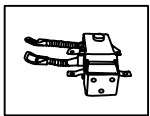

D1×mechanism



E1×seat

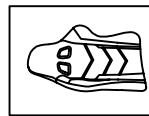

F1×back

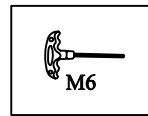

H1×allen key
M6

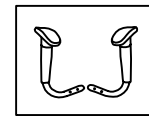

I 2×armrests

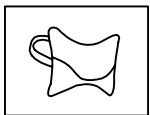

J1×headres

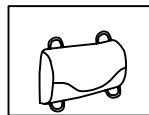

J21×Adjustable
Lumber Suppor

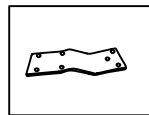

N1 1×Steel plate



Y26 3×screws
M8×20

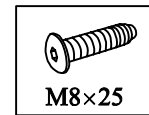

Y8 4×screws
M8×25

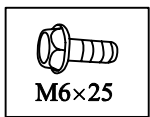

Z13 4×screws
M6×25

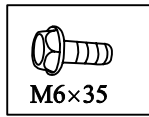

Z26 4×screws
M6×35

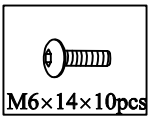

Z2 10×screws
M6×14×10pcs

WARNING

- Do not stand in this chair or use the chair as a step ladder use it as chair only.
- This chair is designed for one person to use at a time.
- This chair is designed for one person weighing up to 250lbs(113kgs).
- Do not use this chair unless all bolts, screws and knobs are firmly secured.
- Check all bolts,screws and knobs every 90days. Tighten if any are loose.
- Failure to follow these instructions may result in serious injury or death of yourself and people around you.
- Some of the part are heavy and/or has shape edge, please install it carefully to avoid hurt you and people around you.

1

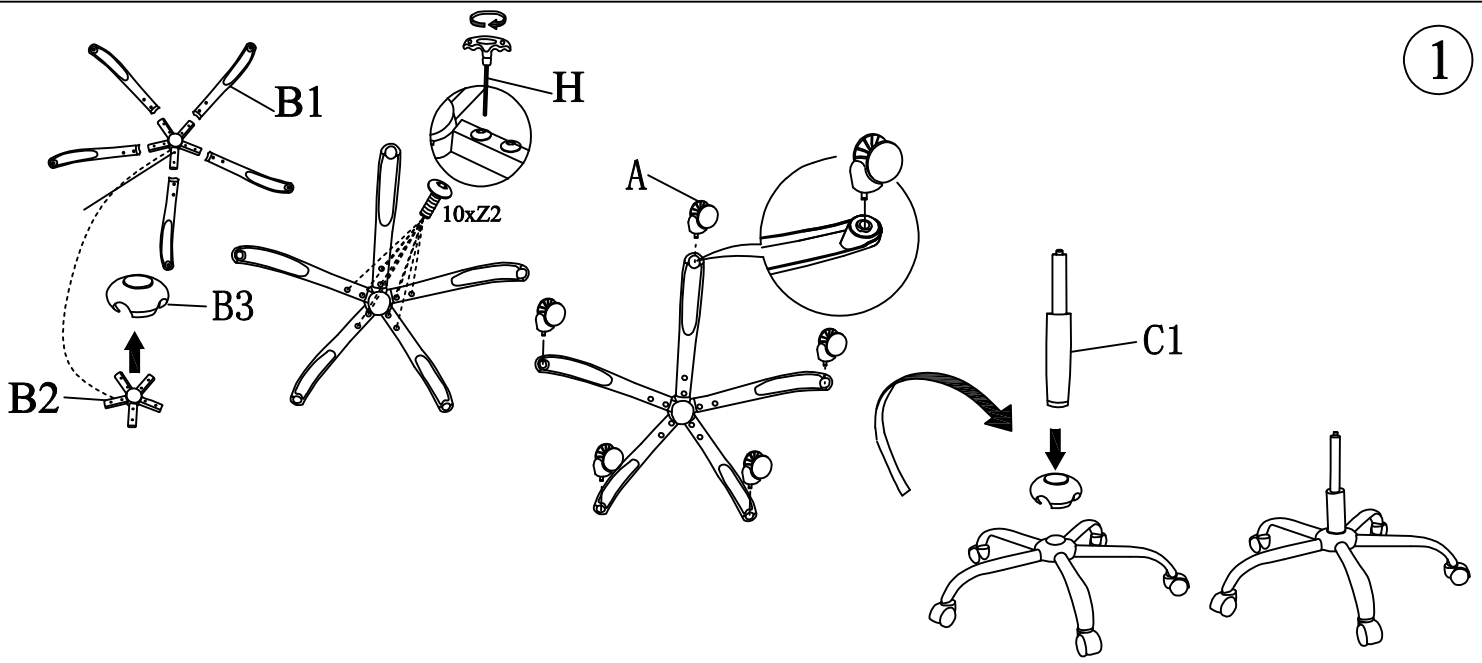

2

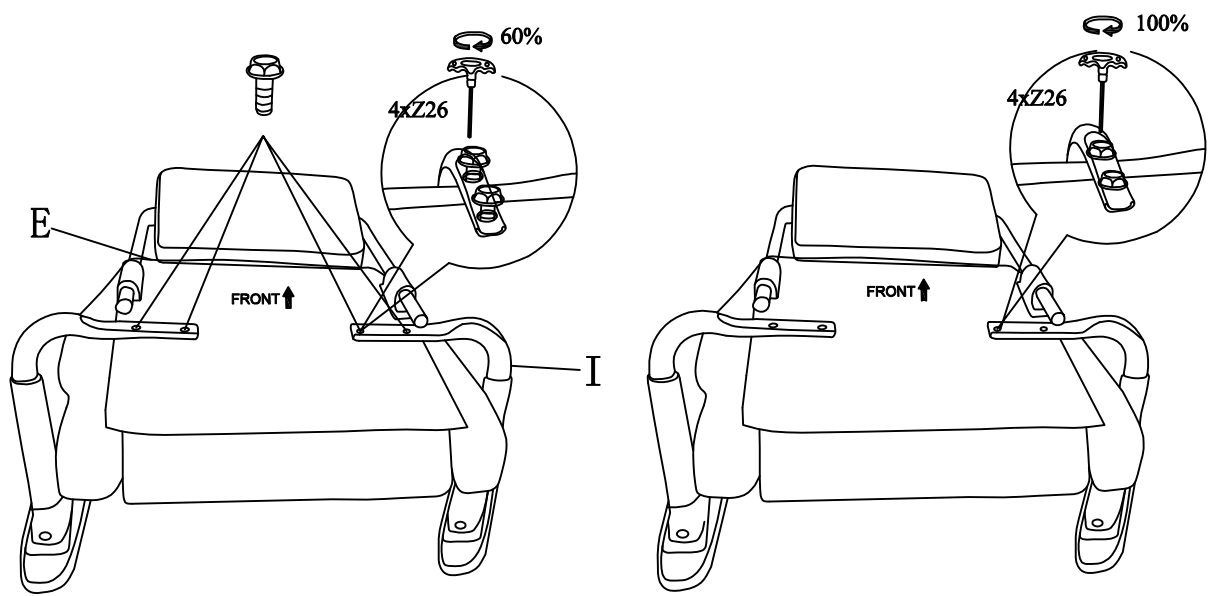

When assemble the armrests, please pull out the footrest first
 Attention: All the screws in, and then tighten them

3

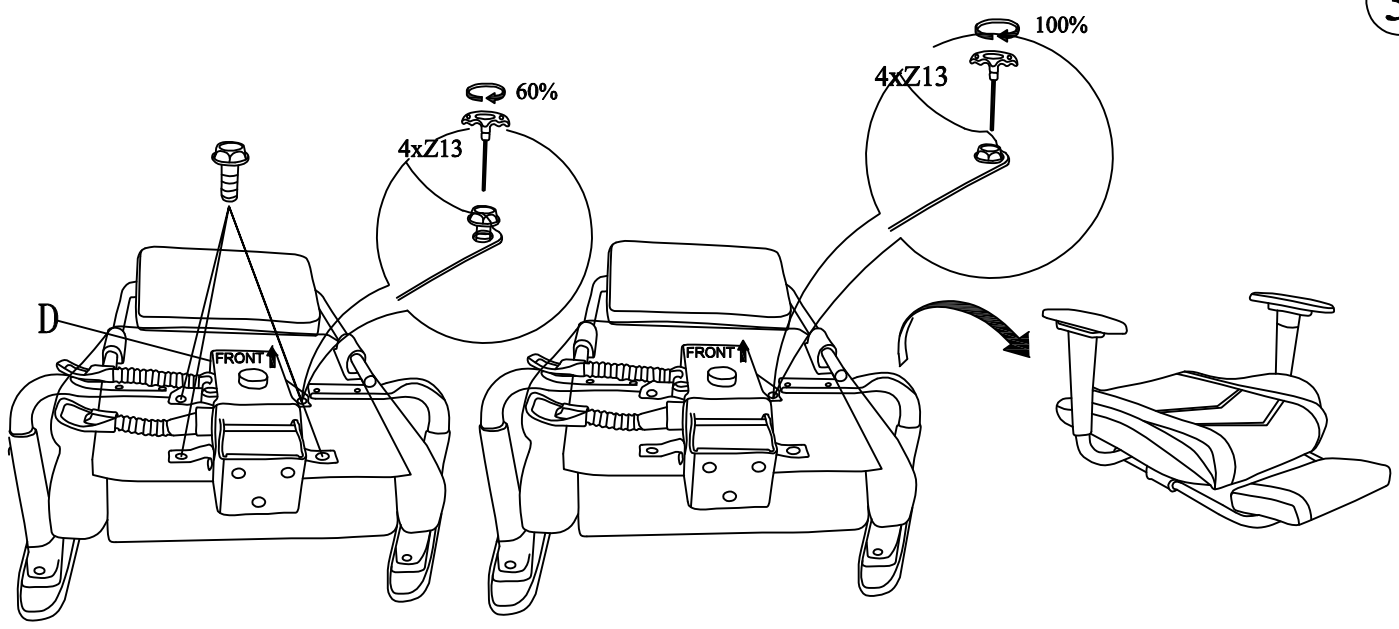

Attention: All the screws in, and then tighten them

4

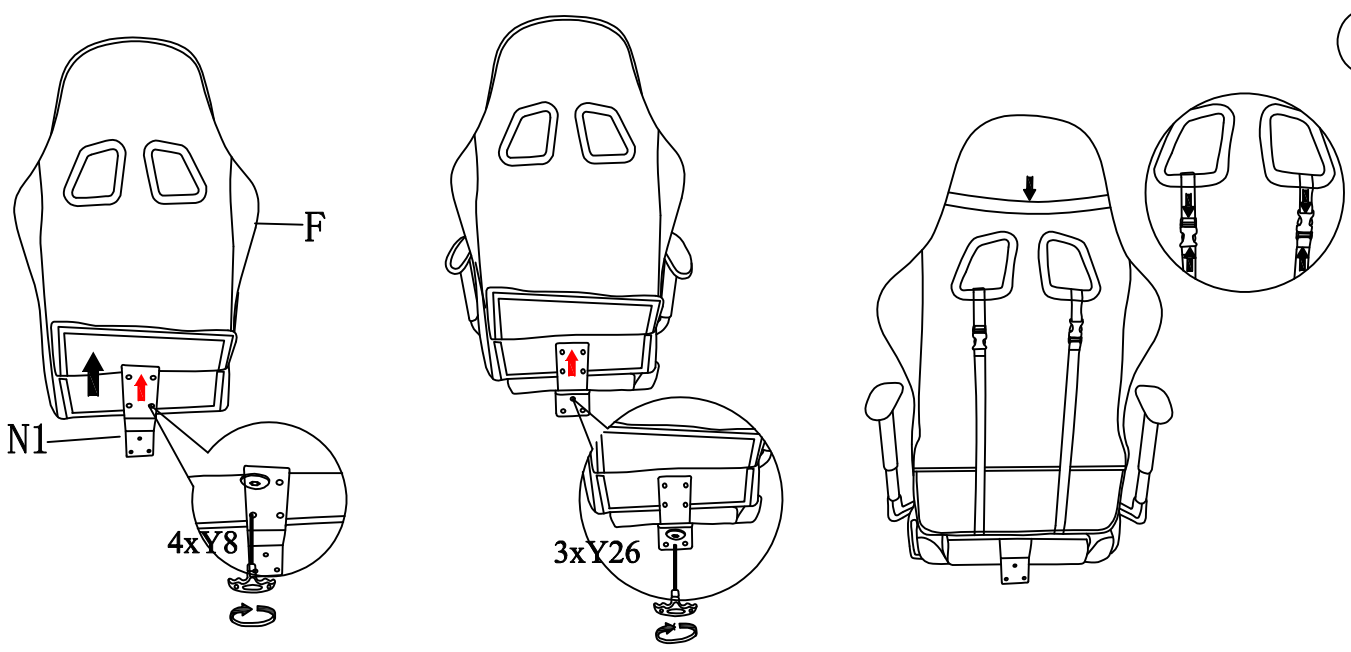

Attention: All the screws in, and then tighten them

5

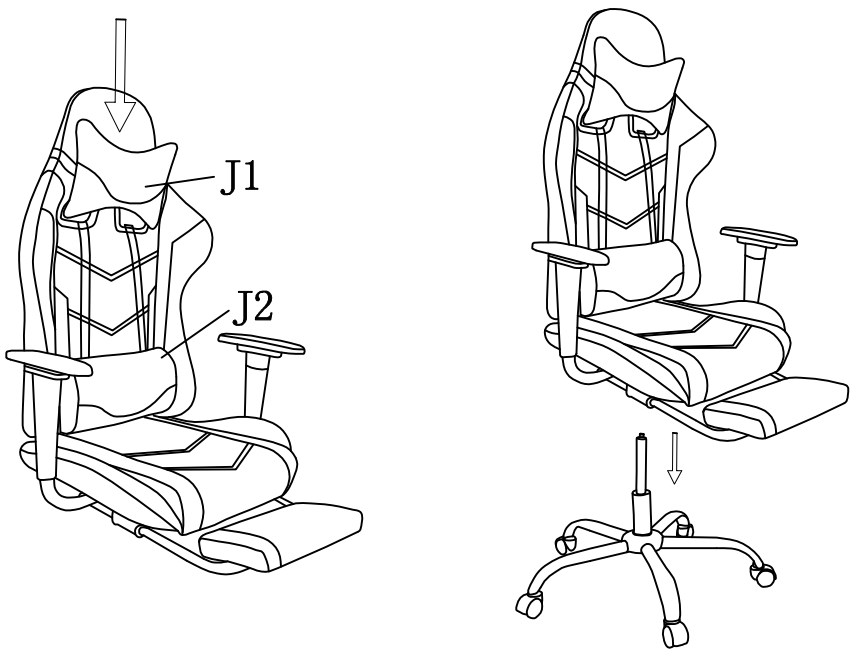

6

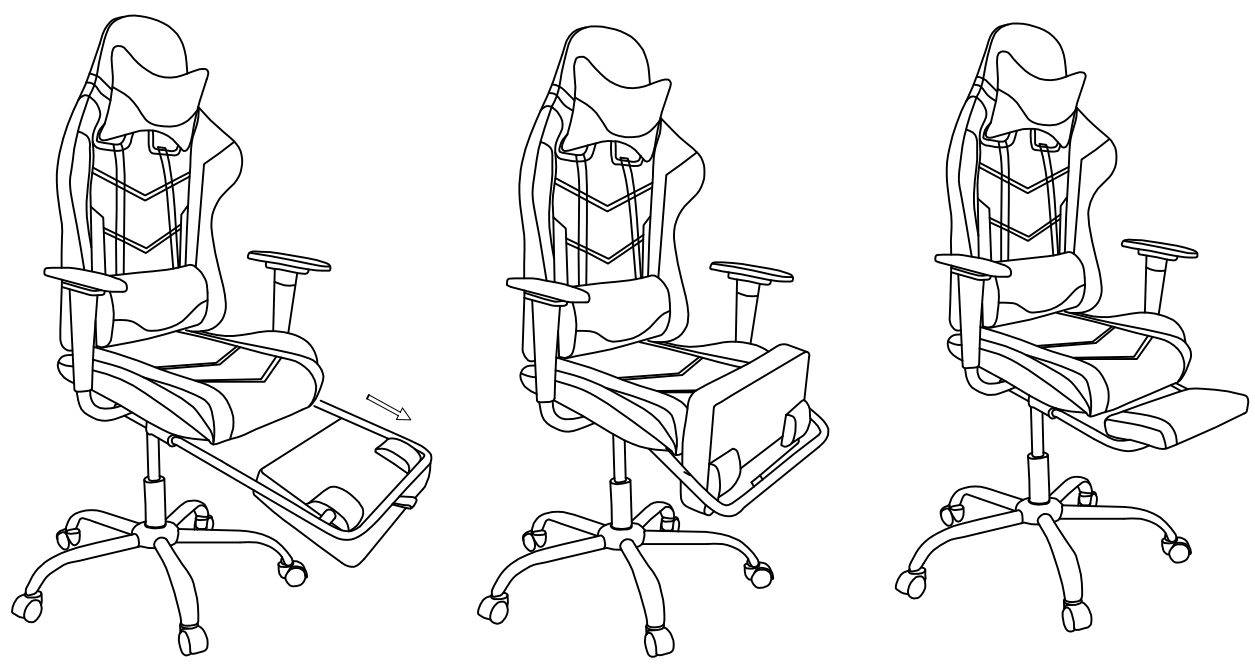

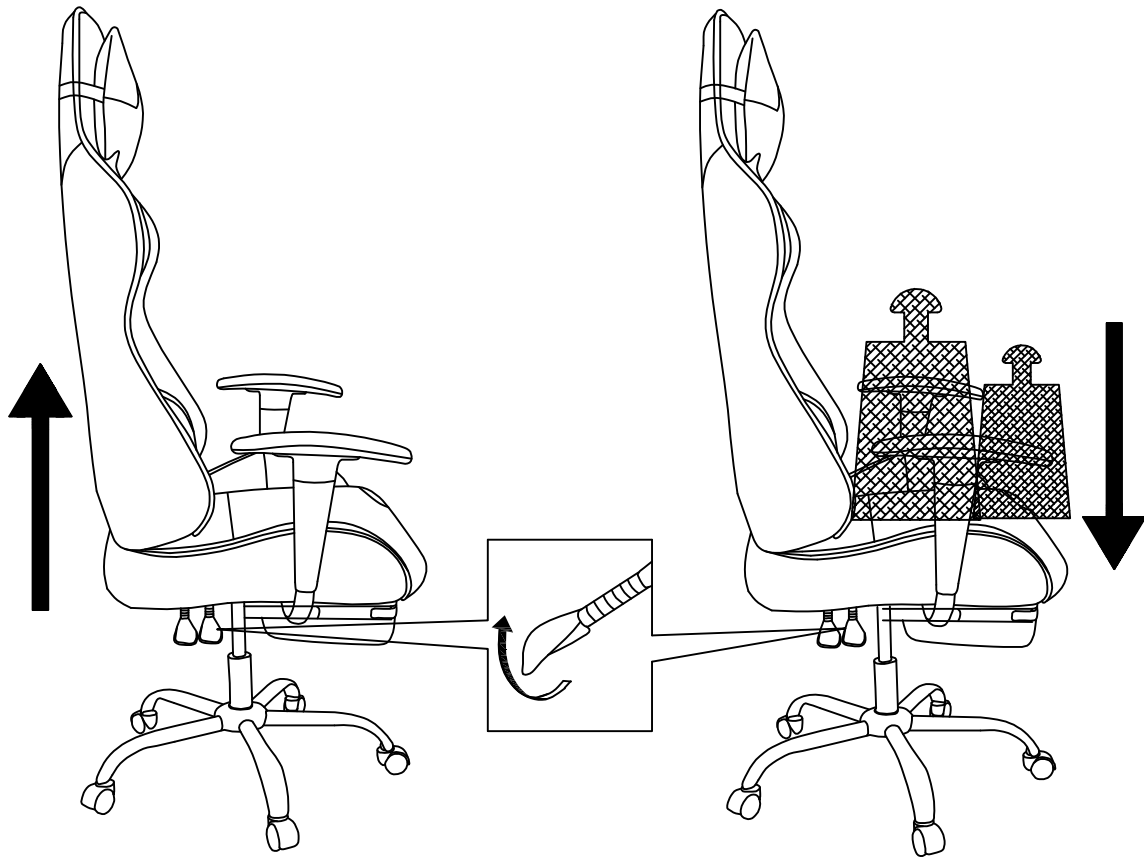

Attention: Please check the upright is locked before use

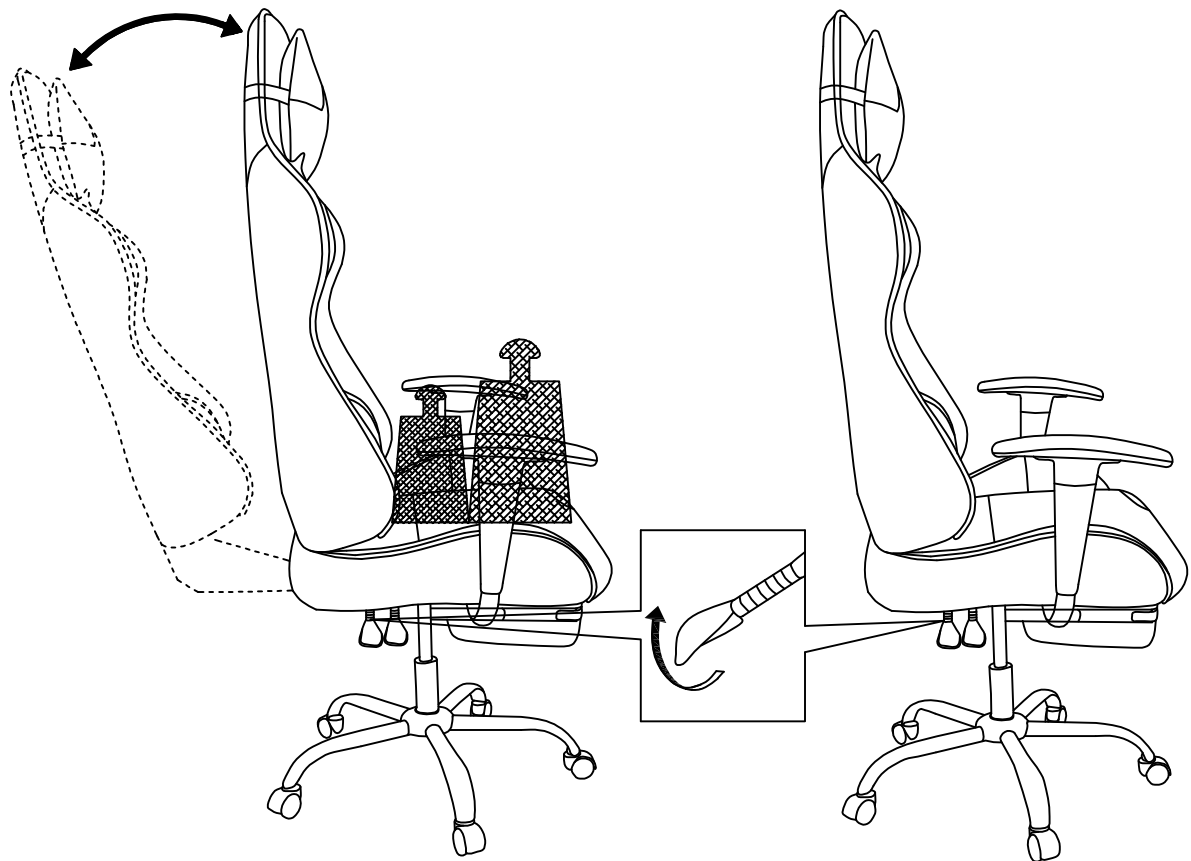

This chair will not lay flat but can recline, in order to recline, please pull the handle on the side out