

# ASSEMBLY INSTRUCTIONS

(2pcs x carton)

Thank you for purchasing our product.

We appreciate your trust and hope you enjoy your new furniture.

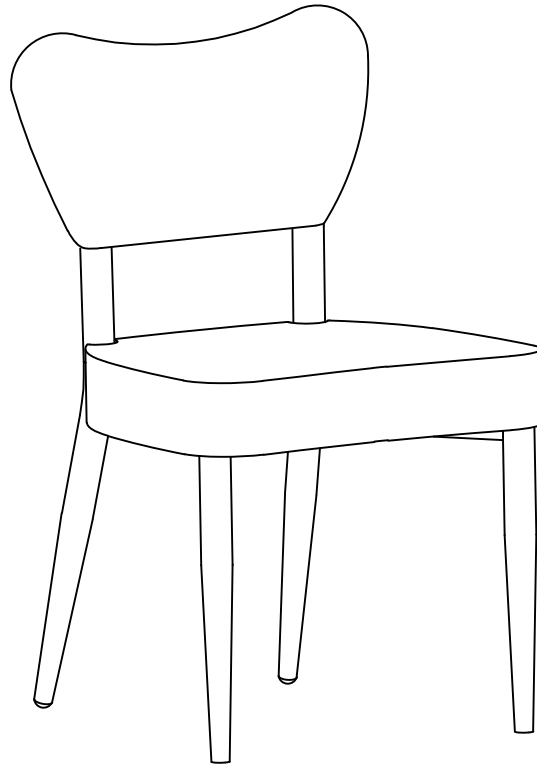

## Notice

1. Place a protective mat or cloth on the floor to prevent scratches.
2. Follow these assembly instructions. Make sure all parts and hardware are included before starting.
3. Do not fully tighten the bolts during assembly. Tighten them only after all parts are properly aligned.

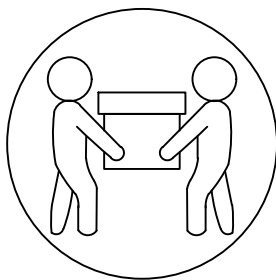

Recommended Assembly: 2 people

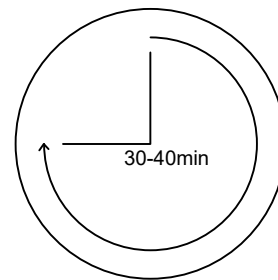



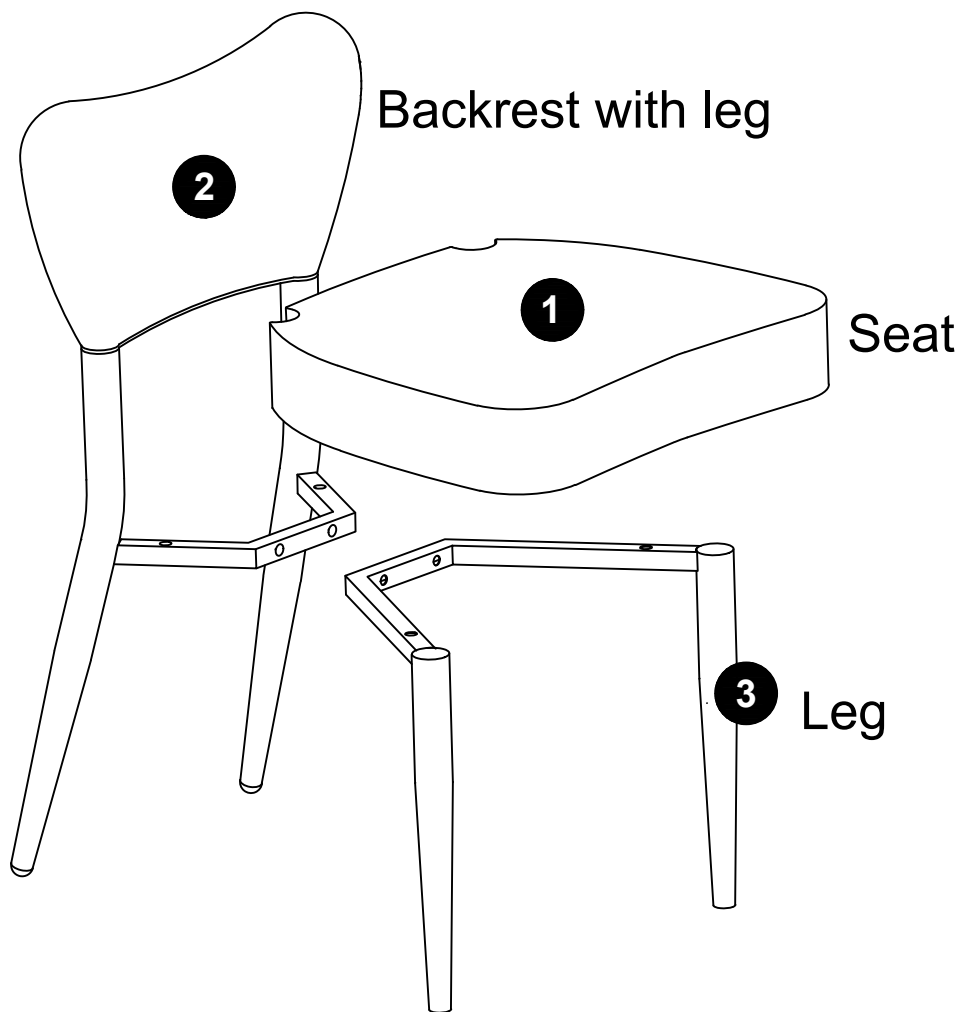

Estimate installation time

# Assembly Explosion Diagram





## HARDWARE LIST

NO.	SKETCH	DESCRIPTION	QTY
A		Bolt(1/4"x1-5/8")	6 PCS
B		Spring washer(1/4")	6 PCS
C		Washer(1/4")	6 PCS
D		Allen wrench(4mm)	1 PC

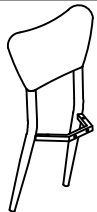
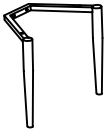
## PARTS LIST

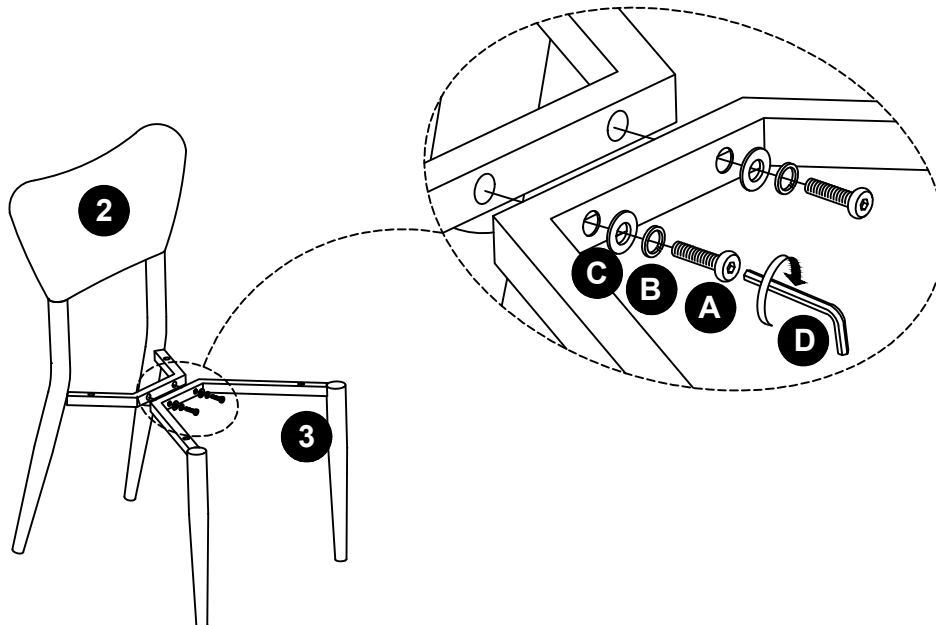

NO.	SKETCH	DESCRIPTION	QTY
1		Seat	1 PC
2		Backrest with leg	1 PC
3		Leg	1 PC

1	<b>A</b> x 2PCS  1/4"x1-5/8"	<b>B</b> x 2PCS  1/4"	<b>C</b> x 2PCS  1/4"
---	---	--	--



Attach Leg(3) to Backrest with leg(2), using Bolt(A), Spring washer(B) and Washer(C) with Allen wrench(D).

**Note: Do not fully tighten the bolts at this step.**

2	<b>A</b> x 4PCS  1/4"x1-5/8"	<b>B</b> x 4PCS  1/4"	<b>C</b> x 4PCS  1/4"
---	---	--	--

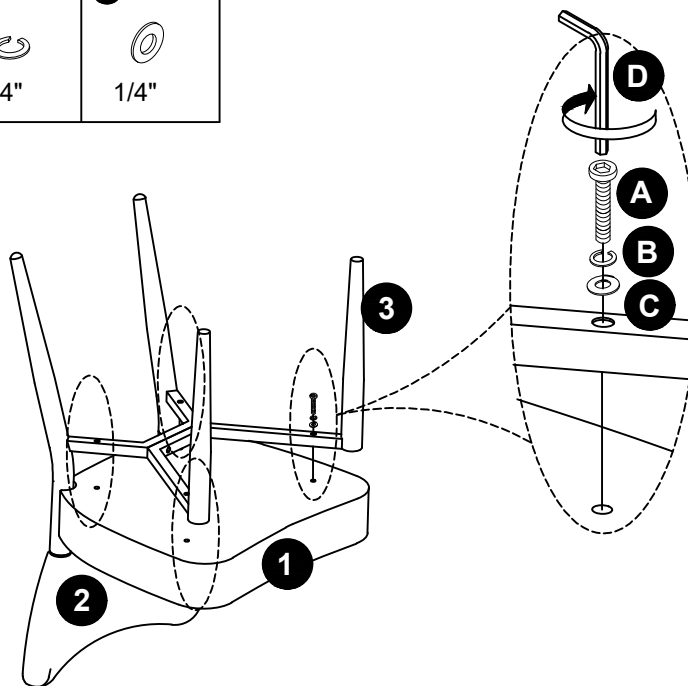

Attach base frame to the bottom of Seat(1), using Bolt(A), Spring washer(B) and Washer(C) with Allen wrench(D).

**Note: Do not fully tighten the bolts at this step.**

3

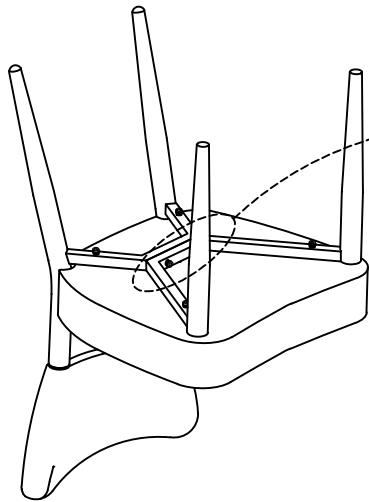

Tighten the screws in the circle first, and then tighten the remaining screws.

4

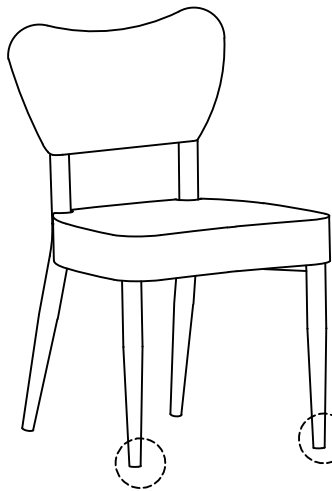

Adjust Pre-installed Levelers height to achieve balance

5

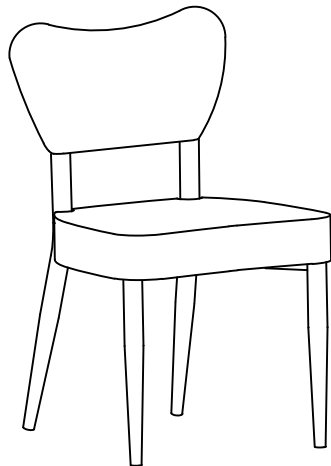

Completed