

# Assembly Instructions

**Caution : You must read this before you proceed**

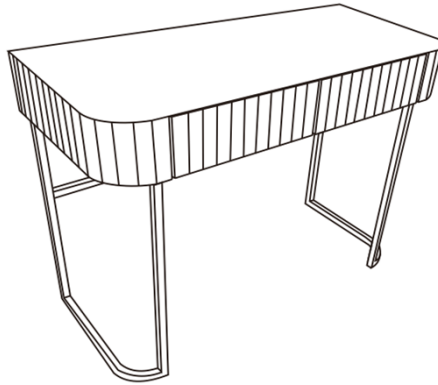



## Table



### PARTS LIST

Label	Picture	Description	QTY
A		Table top	1
B		Left Leg	1
C		Right Leg	1
D		Connector(Middle)	1
E		Connector(Bottom)	1

# Hardware

Label	Picture	Description	QTY
①		M5 Bolt(Short)	8
②		M6 Bolt(Long)	6
③		Washer	6
④		Allen Key	1
⑤		Screwdriver (not provided)	1

## Assembly Preparation

Before Beginning Assembly:

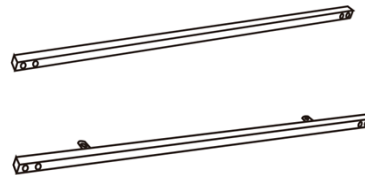
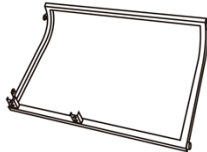
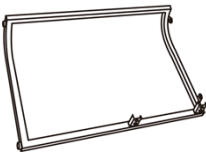
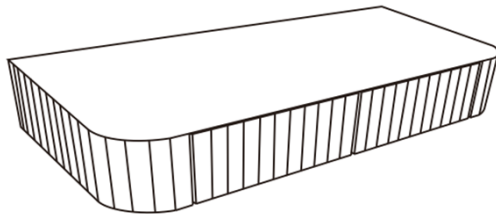

- Read instructions, cover to cover-



- Have 2 adults on hand for assembly-



- Do not assemble on flooring or carpet-



- Assemble on a clean non-marring surface (packing foam)-



- Save all packaging until finished-

# Assembly Steps

## Overview

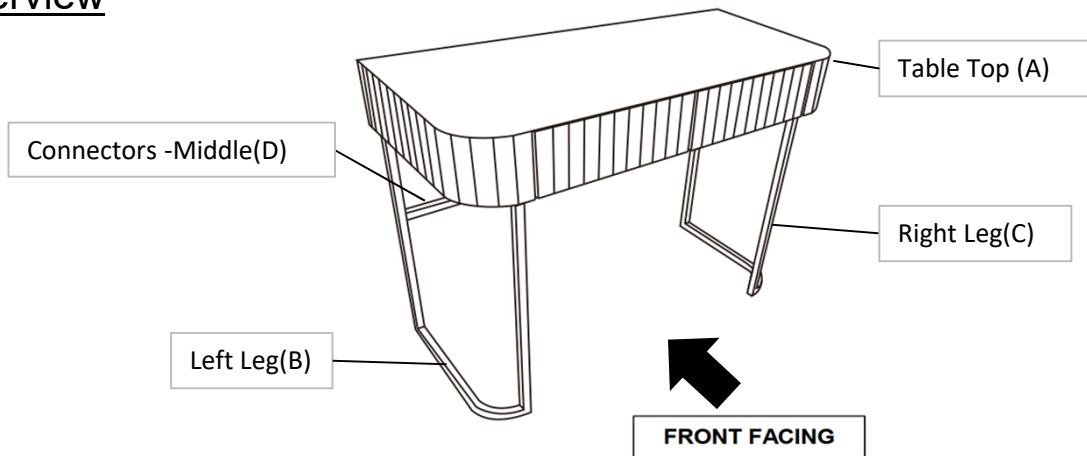

This Table has multiple parts and may require up to 30 minutes to assemble. To give you an overview of the Table parts, the above picture is to help you put the various parts into perspective. Please read through the instructions below to familiarise yourself with the parts and steps before assembly.

## Step 1

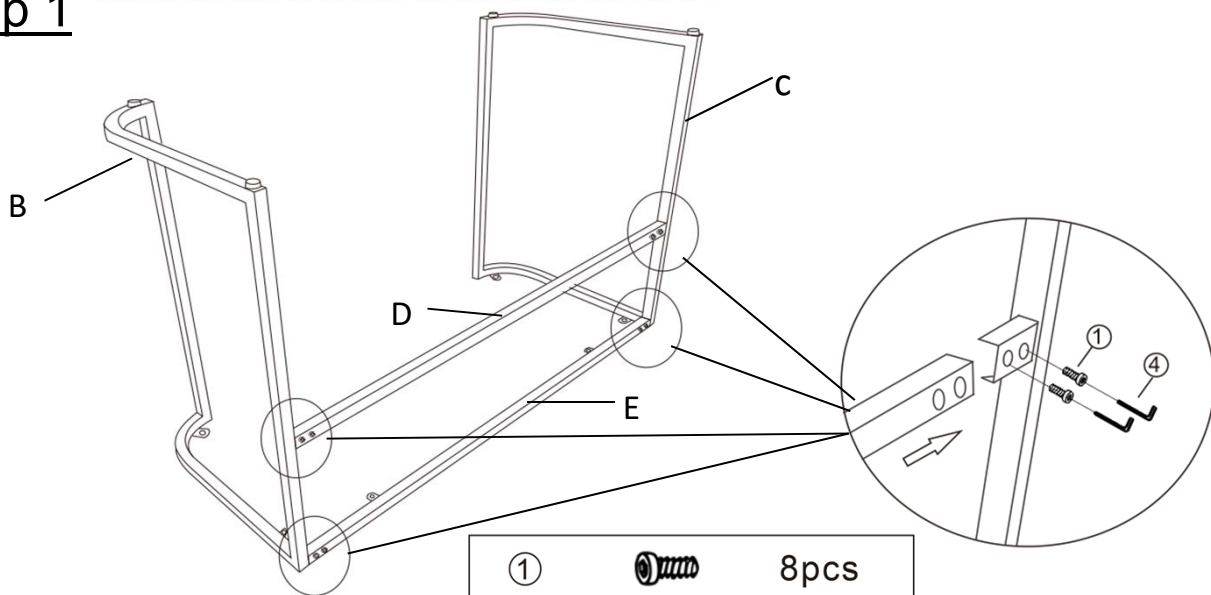

Open the carton, with the help of your adult partner, take the Table out carefully,  
Put the Table on a soft surface downward,  
Take the Legs and connectors out and place them on a clean, non-marring surface.  
With help from an adult partner, Assemble the legs and connectors on a clean, non-marring surface. Assemble Legs (B,C) with Connectors (D,E) using short Bolts (①) and Allen Key (④).

## Step 2

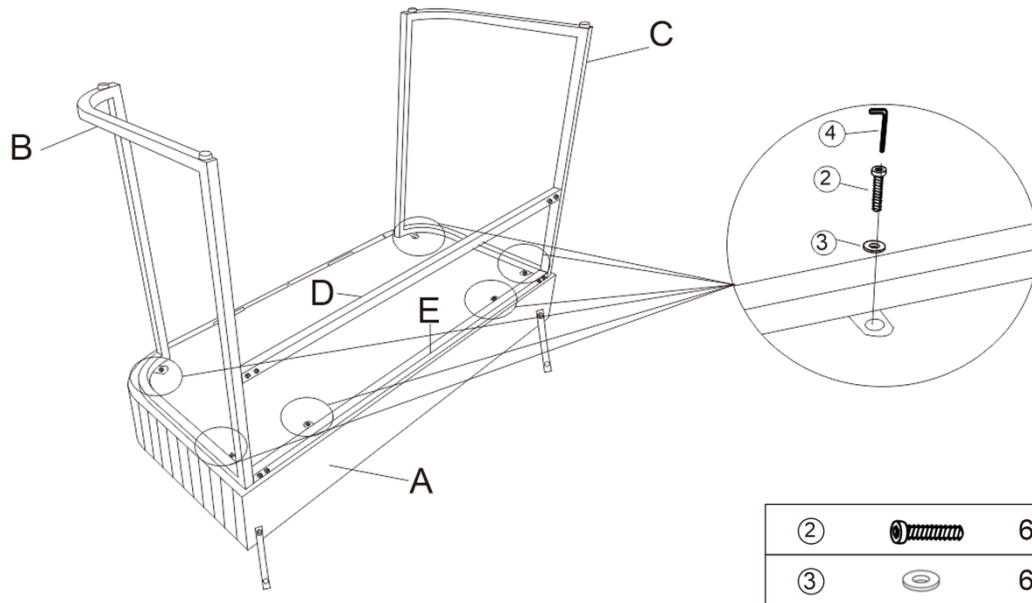

Place the legs(B,C) on the mounting position in the Table(A).  
Attach Legs(B,C) to Table(A) using long Bolts(②), and Washers(③) with Allen Key(④).

## Step 3

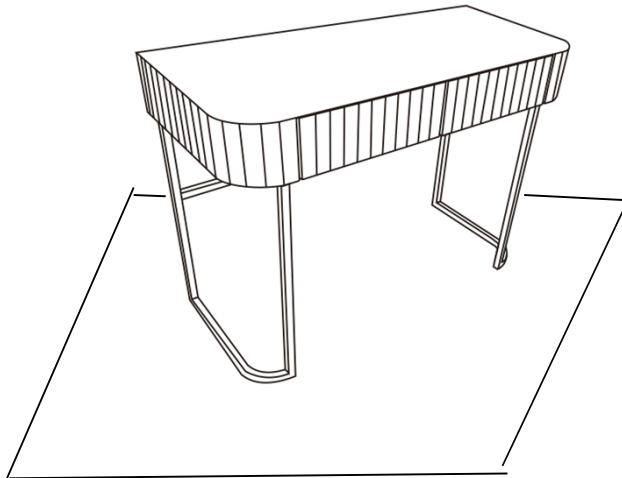

Place Table on a level surface, to check for wobbles.  
If there are wobbles, turn the adjustable feet at the legs bottom to keep the table at a same level.  
Your Table is ready for use.  
This Table can only be used on a flat, level surface.

 **WARNING**

**Serious or fatal crushing injuries can occur from tipping furniture. To help prevent tip-over: ALWAYS secure this furniture to the wall using Restraint Device. See product instructions for more ways to help prevent furniture tip-over.**

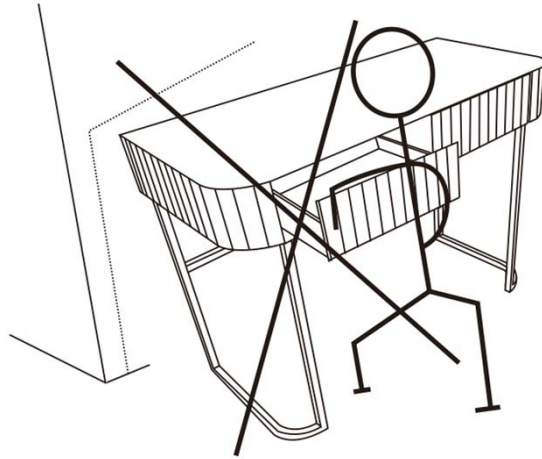







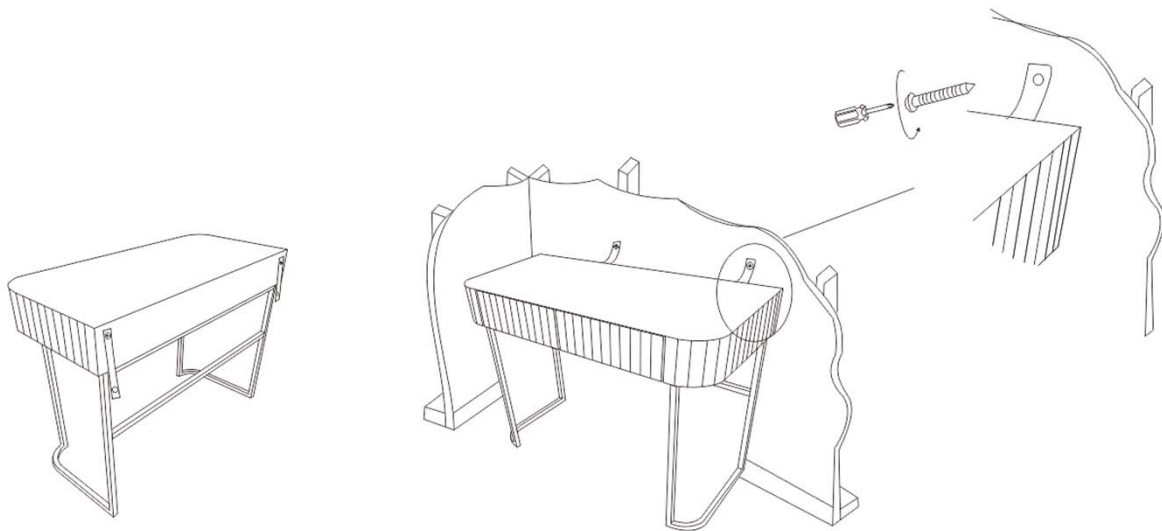



**Usage for Restraint Device:**

Move the Table against the wall, Pull out the Restraint Device Straps from the product, use screw driver to lock the strap with a screw on the wall.

The screw and screw driver is NOT included.



## Care & Maintenance

-  ● Do not put hot items directly on furniture surface
  -  ● Do not clean furniture with harsh cleansers or polish.
  -  ● Do not place furniture under direct sunlight.
  -  ● Do not place furniture near heating or cooling vents.
  -  ● Do not write on furniture without a padded barrier to protect the surface.
  -  ● Do not place furniture outside . For indoor use only .
  -  ● Not for commercial use. For residential use only .
  -  ● Stains may be removed with mild soap solution and damp cloth.
  -  ● Children should not climb or jump on the furniture.
- 
- ✓  ● Dust and pick-up spills using a clean, non-colored, lint-free cloth .