

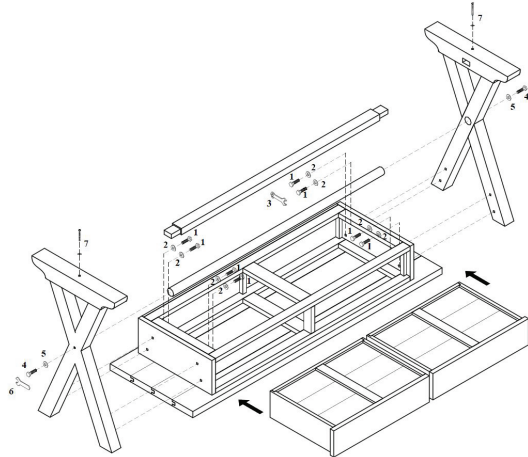





ASSEMBLY INSTRUCTIONS

SOFA TABLE

A. Clear the area where the sofa table is to be installed

B. Unpack the sofa table and dispose of the recyclable packing material in a responsible manner.



PART LIST			QUANTITY
1	BOLT Ø 10 x 40		8
2	WASHER Ø 11 x 26 x 1.8		8
3	RING SPANNER K17 x 25 x 135		1
4	BOLT Ø 8 x 60		2
5	WASHER Ø 8 x 19 x 1.2		2
6	RING SPANNER K13 x 28 x 90		1
7	SCREW Ø4 x 40		2

BEFORE YOU START:

1. Assembly requires two adults.
2. Check the parts against the parts list to make sure all items are present.
3. We suggest to place the table upside down on a blanket to protect it from scratching.
4. Take out the drawers.
5. Attach the legs using bolt (1), washer (2) and horizontal frame with bolt (4), washer (5)
6. Tighten all bolts using ring spanner (3) & (6) then fit the screw and washer (7) (as picture).



Carefully turn the table on to its feet, and turn the drawer stops down.

Thank you for purchasing furniture !