









Assembly Instructions

Caution : You must read this before you proceed

Care & Maintenance

- ⊘  • Not for commercial use. For residential use only.
- ⊘  • Do not put hot items directly on furniture surface.
- ⊘  • Do not clean furniture with harsh cleansers or polish.
- ✓  • To obtain the longest lifespan of your outdoor products, minimizing exposure to direct sunlight is recommended.
- ⊘  • Children should not climb or jump on the furniture.
- ⊘  • Do not write on furniture without a padded barrier to protect the surface.
- ✓  • To obtain the longest lifespan of your outdoor products, avoid extended and lengthy exposure to rain, snow, and direct sunshine. Whenever possible cover the product and /or place under patio or awnings.
- ⊘  • Stains may be removed with mild soap solution and damp cloth.

- ✓  • Dust and pick-up spills using a clean, non-colored, lint-free cloth.



Please look in carton corner for hardware packs

Remind: Umbrella open diameter max. 71 inches to 80inches.

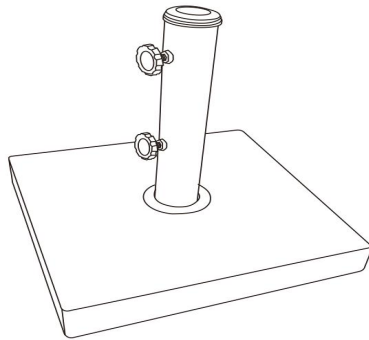



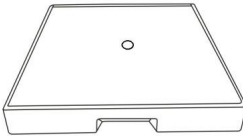

Umbrella Base(N775P256432N)



Parts List

Label	Picture	Description	QTY
A		Umbrella Base	1
B		Support Pole	1





Hardware

Label	Picture	Description	QTY
①		Rotary Button	2
②		Washer Ring	1
③		Gasket	1
④		Socket Wrench	1
⑤		Spring Spacers	1
⑥		Locking Bolt	1

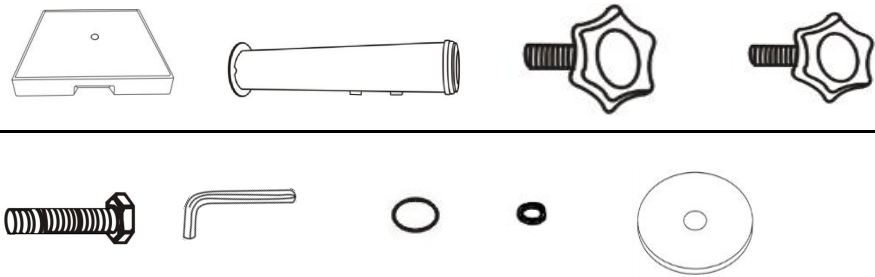
Assembly Preparation

Before Beginning Assembly:



-  Read instructions, cover to cover-
-  Have 2 adults on hand for assembly-
-  Do not assemble on flooring or carpet-
-  Assemble on a clean non-marring surface (packing foam)-
-  Save all packaging until finished-

WARNING: AVOID CHOKING / CHOKING HAZARDS : DO not allow children to play with plastic wraps and /any small parts in this package .

Notice: As a safety precaution, when umbrella is not in use please turn down umbrella . Remove Umbrella from this and store in safe location.

ATTENTION: This Umbrella Base is exclusively recommended to be used together under a table with the matching umbrella with diameter of 71 inches to 80 inches. The matching Support Pole diameter 35mm-48mm.

Assembly Steps

Overview

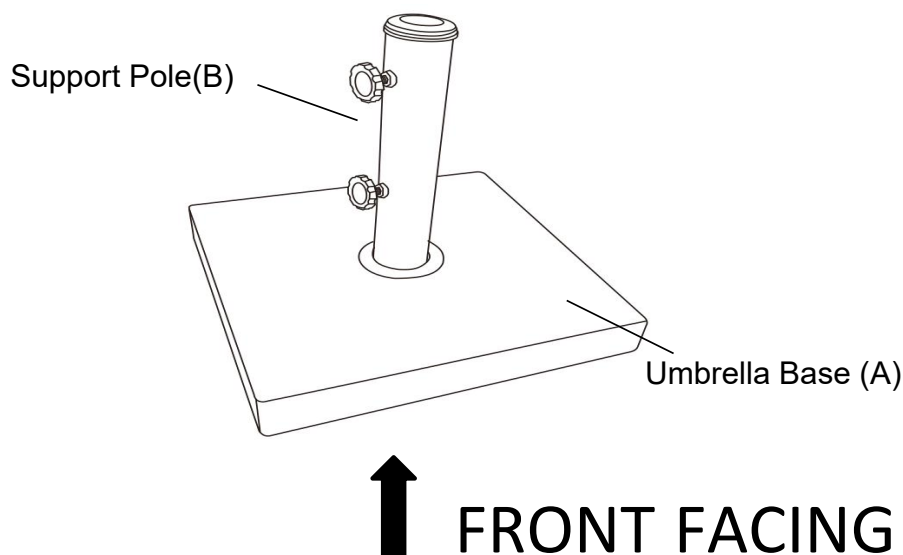

This Umbrella Base has multiple parts and may require up to some 15 minutes to assemble. To give you an overview of the Umbrella parts, the above picture is to help you put the various parts into perspective. Please read through the instructions below to familiarise yourself with the parts and steps before assembly.

Step 1

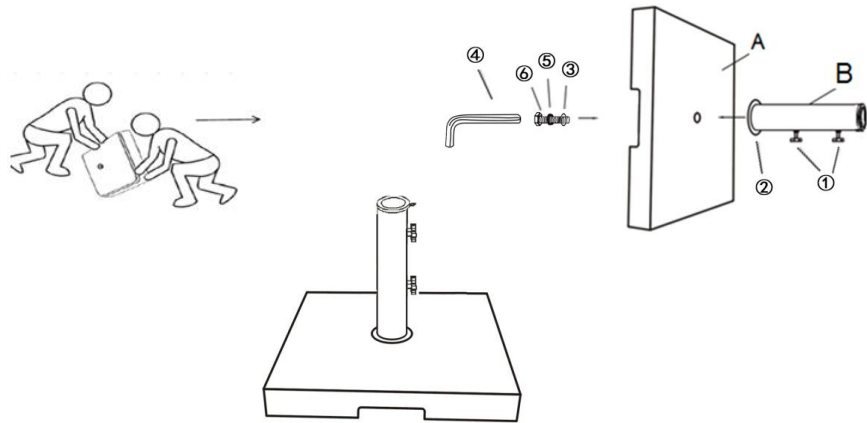

This is a two person team assembly product.

First, attach Rotary Button(①) to Support Pole(B), then attach Support Pole(B) and Washer Ring(②) to Umbrella Base(A) using Gasket(③) and Spring Spacers(⑤) Locking Bolt(⑥) with Socket Wrench(④).

Tighten Bolt until fully secure.

Operation Instruction

For Umbrella Pole with 48mm diameter:

Insert the 48mm Adapter into the Support Pole(B). Pull out the 35mm 38mm Adapter; Then insert your 48mm Umbrella Pole. Tighten the Rotary Button on the Support Pole securely in a sequential manner to your Umbrella Pole. The Umbrella Base is ready for use.

This Umbrella Base only be used on a flat, level surface.

For Umbrella Pole with 38mm diameter:

Insert the 48mm & 38mm Adapter into the Support Pole(B). Pull out the 35mm Adapter;

Then insert your 38mm Umbrella Pole. Tighten the Rotary Button on the Support Pole securely in a sequential manner to your Umbrella Pole. The Umbrella Base is ready for use.

This Umbrella Base only be used on a flat, level surface.

For Umbrella Pole with 35mm diameter:

Insert the 48mm & 38mm & 35mm Adapter into the Support Pole(B). Then insert your 35mm Umbrella Pole. Tighten the Rotary Button on the Support Pole securely in a sequential manner to your Umbrella Pole. The Umbrella Base is ready for use.

This Umbrella Base only be used on a flat, level surface.