



# ASSEMBLY INSTRUCTION

## LOVE SEAT

LEGS ARE STORED IN THE BOTTOM OF THE SEAT, PLEASE TAKE OUT FOR ASSEMBLY.

NO.	PARTS LIST	QTY	DESCRIPTION
A		1	LOVE SEAT

NO.	HARDWARE LIST	QTY	DESCRIPTION
B	 ø106*70mmH	4	WOODEN LEGS

# ASSEMBLY INSTRUCTION

## LOVE SEAT

### STEP # 1

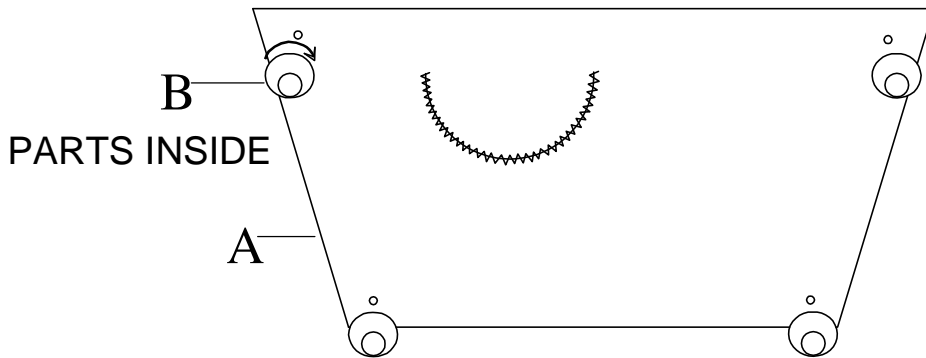

### STEP # 2

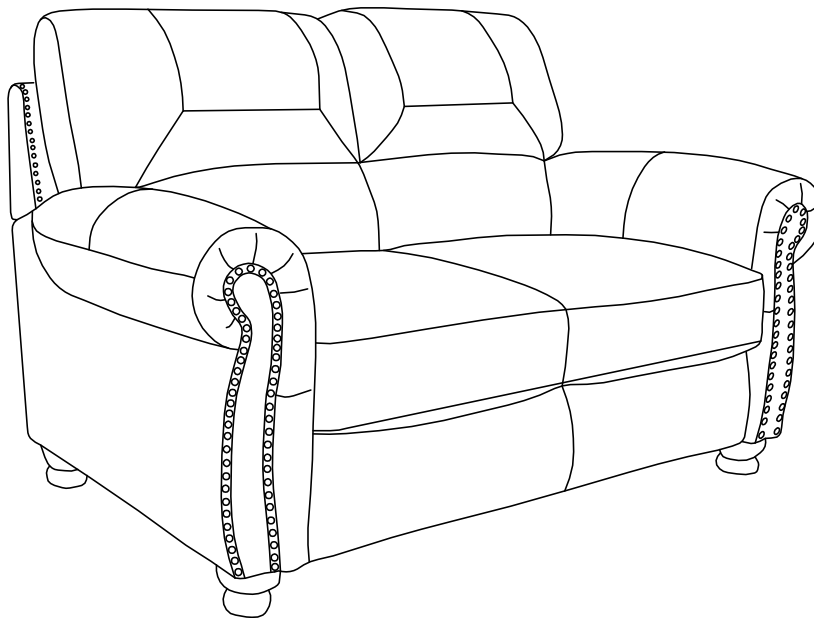

#### CARE INSTRUCTION FOR TOP LEATHER WITH PU FURNITURE

In order to maintain the original appearance of your furniture, please follow below care procedures.

°Avoid exposing furniture directly to sunlight or heating and air conditioning outlets. sunlight and/ or exposure to heating and air conditioning outlets will fade/damage top leather with PU. Do not place your upholstered furniture too close to windows, radiators, vents and be sure to use window treatments to block the sun's rays.



°Wipe with a soft brush to remove dust.

# ASSEMBLY INSTRUCTION

## SOFA

LEGS ARE STORED IN THE BOTTOM OF THE SEAT, PLEASE TAKE OUT FOR ASSEMBLY.

NO.	PARTS LIST	QTY	DESCRIPTION
A		1	SOFA

NO.	HARDWARE LIST	QTY	DESCRIPTION
B	 ø106*70mmH	4	WOODEN LEGS
C	 H70mm	1	PLASTIC MID FEET

# ASSEMBLY INSTRUCTION

## SOFA

### STEP # 1

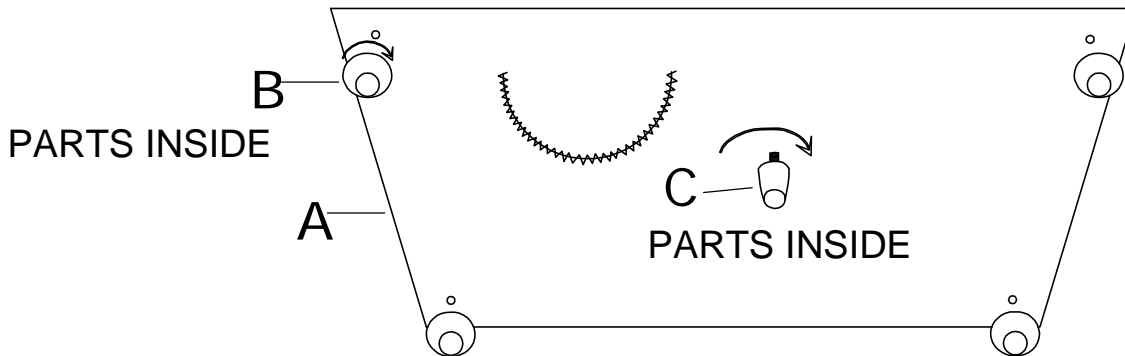

### STEP # 2

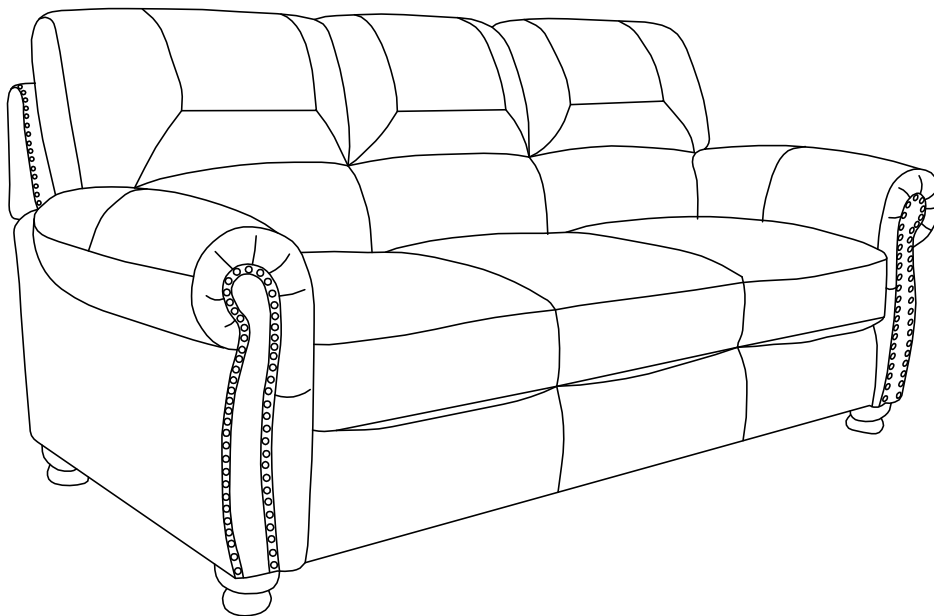

#### CARE INSTRUCTION FOR TOP LEATHER WITH PU FURNITURE

In order to maintain the original appearance of your furniture, please follow below care procedures.

°Avoid exposing furniture directly to sunlight or heating and air conditioning outlets. sunlight and/ or exposure to heating and air conditioning outlets will fade/damage top leather with PU. Do not place your upholstered furniture too close to windows, radiators, vents and be sure to use window treatments to block the sun's rays.

°Wipe with a soft brush to remove dust.