

SOU2104TG



Category	24"
Product family	Oven
Power supply	Electrical
Cooking method	Thermo-ventilated
Cleaning system	VaporClean
EAN code	8017709342869



Aesthetic

Aesthetics	Linea	Silkscreen color	Black
Color	Neptune Grey	Silkscreen type	Symbols
Design	Flat	Door	Full-glass
Material	Glass	Handle	Neptune 24" BIG
Stainless steel type	Brushed	Handle color	Stainless steel
Glass type	Clear1	Logo	Silkscreened

Controls













Display name	VivoScreen	No. of display languages	8
Display technology	TFT	Display languages	Italiano, English (US), Français (CA), Español (MX), Português (PT), zh-CHS, zh-CHT
Controls setting	Full-touch		





Programs / Functions

No. of cooking functions	10
Automatic programmes	50
Customisable recipes	10

Traditional cooking functions

 Static	 Fan-assisted	 True European convection
 Turbo	 Eco	 Large grill
 Fan grill (large)	 Circulaire + grill	 Bottom
 Convection bottom		

Other functions

 Defrost by time	 Defrost by weight	 Proof
 Plate warmer	 Sabbath	

Cleaning functions

 Vapor Clean
--

Options



Time-setting options	Delayed start and automatic shut-off when cooking ends	Smart cooking	Yes
Minute minder	Yes	Showroom mode	Yes
Timer	1	Chronology	Last 10 functions operated
Child safety lock	Yes	Rapid pre-heating	Yes
Other options	Keep-warm, Eco light, Language setting, Digital clock, On/off tones		

Technical Features



Minimum Temperature	32 °F	Heating elements stop when door is opened	Yes
Maximum temperature	282 °F	Door opening	Standard opening
No. of shelves	5	Door	Cool-touch door
Fan	Single	Removable door	Yes
No. of lights	2	Full-glass inner door	Yes
Lighting	Halogen	Removable inner door	Yes
Replaceable light	Yes	Total no. of door glasses	4
Light power	40 W	Soft Close	Yes
Light on when door is open	Yes	Cooling system	Tangential
Lower heating element power	1200 W	Cooling duct	Single
		Cooling System Speed Reduction	Yes

Upper heating element - 1000 W
Power
Grill element - power 1700 W
Large grill - Power 2700 W
Circular heating element 2000 W
- Power

Inner cavity dimensions 360x460x425 mm
(HxWxD)
Temperature control Electronic
Cavity material EverClean enamel

Accessories Included



Rack with back stop 2
Enameled 1.6"-deep tray 1

Insert grid 1
Telescopic Guide rails, partial Extraction 1

Electrical Connection

Voltage 120/240 V
Plug Hard-wired
Current 15 A
Voltage 120/208 V

Current 13 A
Frequency 60 Hz
Power cord length 59 1/16 "

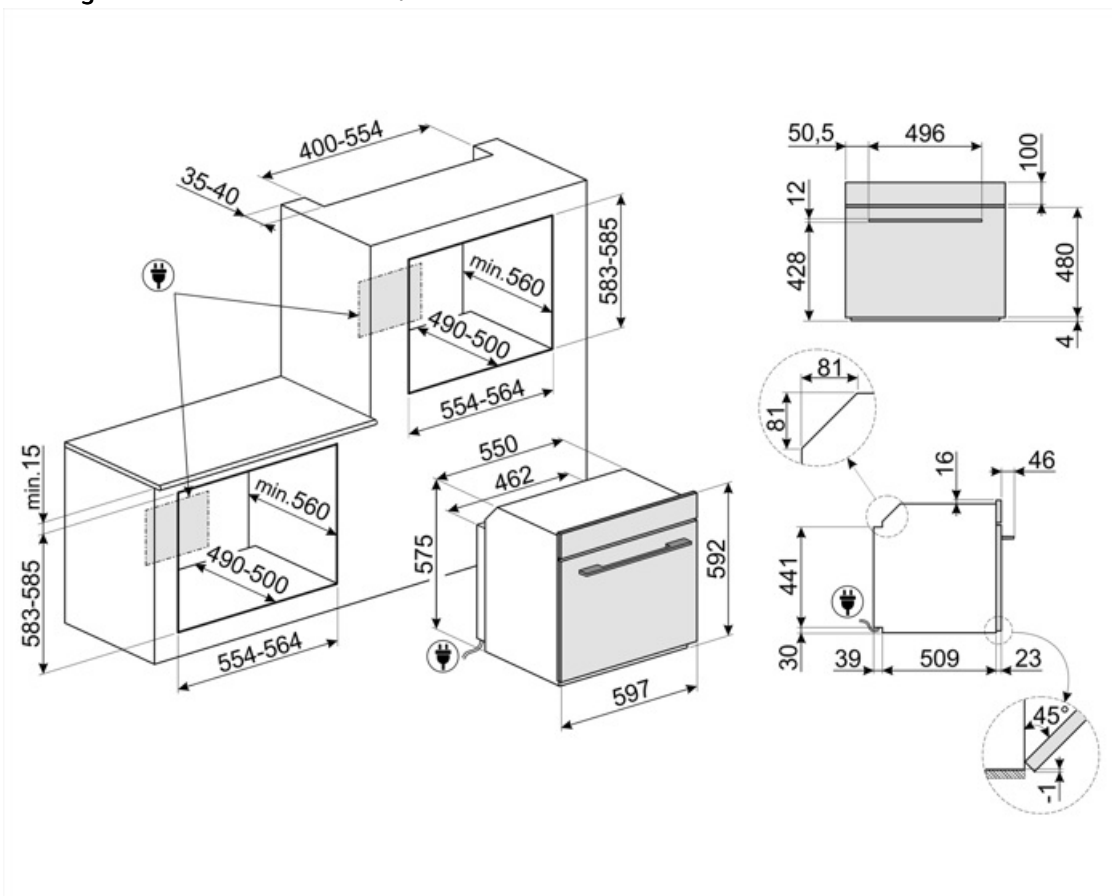

Compatible Accessories

BN620-1

Enamelled tray, 20mm deep



GTP

****Partial-extension telescopic guides****
Length: 14" Extraction: 11 1/4" Material:
Stainless steel AISI 430 polished



PALPZ

Pizza shovel with fold away handle
width: 315mm length : 325mm



BN640

Enamelled tray, 40mm deep



GTT

****Total-extension telescopic guides****
Length: 14" Extraction: 16.5" Material:
Stainless steel AISI 430 polished



STONE2

Rectangular pizza stone without handles, suitable for 45cm and 60cm wide ovens. Dimensions W42 x H1.8 x D37.5cm. Ideal for cooking pizzas with the same results as a typical wood-fired oven. Can also be used for baking bread, focaccias and other recipes such as pies, flans or biscuits



















Alternative products























SOU2304TX

Stainless steel

Symbols glossary

 <p>Child lock: some models are fitted with a device to lock the programme/cycle so it cannot be accidentally changed.</p>	 <p>Air cooling system: to ensure a safe surface temperatures.</p>
 <p>Defrost by time: with this function the time of thawing of foods are determined automatically.</p>	 <p>Defrost by weight: With this function the defrosting time is determined</p>
 <p>Quadruple glazed: Number of glazed doors.</p>	 <p>Automatic lighting switches off: for greater energy savings, the lighting switches off automatically after one minute from the start of cooking.</p>
 <p>Electric</p>	 <p>Enamel interior: The enamel interior of all Smeg ovens have a special antacid lining which helps keep the interior clean by reducing the amount of cooking grease adhering to it.</p>
 <p>Fresh Touch: Most of Smeg ovens have a "cool door." Thanks to the combination of tangential cooling and internal heat-reflecting glasses, the temperature on the outer surface of the door is maintained below 50° C. In addition to providing safety, this system protects the sides of the furniture from overheating by the oven.</p>	 <p>Circogas: In gas ovens the fan distributes the heat quickly and evenly throughout the oven cavity, avoiding flavour transfer when cooking a number of different dishes at the same time. In electric ovens this combination completes cooking more quickly of foods that are ready on the surface, but that require more cooking inside, without further browning.</p>
 <p>Fan with upper and lower elements: The elements combined with the fan aim to provide more uniform heat, a similar method to conventional cooking, so pre-heat is required. Most suitable for items requiring slow cooking methods.</p>	 <p>Upper and lower element only: a traditional cooking method best suited for single items located in the centre of the oven. the top pf the oven will always be hottest. Ideal for roast, fruit cakes, bread etc.</p>
 <p>Lower heating element only: This function is ideal for foods that require extra base temperature without browning, e.g. pastry dishes, pizza. Also suitable for slow cooking of stews and casseroles.</p>	 <p>Circulaire + grill: Circulaire with upper element or grill: Similar to fan with upper element with the added cooking speed of circulaire, ideal for dishes with a crispy topping. When used with the grill the food will brown more quickly.</p>
 <p>True European Convection: The combination of the fan and circular heating element around it provides many benefits, including no preheat if cooking time is longer than 20 minutes, no flavor transfer when cooking different foods at the same time, lower energy consumption, and shorter cooking times. Suitable for all types of food preparations.</p>	 <p>ECO: The combination of the grill, fan and lower element is particularly suitable for cooking small quantities of food.</p>

- | | |
|---|--|
|  <p>Grill element: Using of grill gives excellent results when cooking meat of medium and small portions, especially when combined with a rotisserie (where possible). Also ideal for cooking sausages and bacon.</p> |  <p>Fan with grill element: The fan reduces the fierce heat from the grill, providing an excellent method of grilling various foods, chops, steaks, sausages etc. giving even browning and heat distribution, without drying out the food. The top two levels recommended for use, and the lower part of the oven can be used to keep items warm at the same time, an excellent facility when cooking a grilled breakfast. Half grill (centre portion only) is ideal for small quantities of food.</p> |
|  <p>Circulaire with upper and lower elements: The use of the fan with both elements allows food to be cooked quickly and effectively, ideal for large joints that require thorough cooking. It offers a similar result to rotisserie, moving the heat around the food, instead of moving the food itself, enabling any size or shape to be cooked.</p> |  <p>All glass inner door: All glass inner door, a single flat surface which is simple to keep clean.</p> |
|  <p>The inner door glass: can be removed with a few quick movements for cleaning.</p> |  <p>KEEP_WARM_72dpi</p> |
|  <p>Side lights: Two opposing side lights increase visibility inside the oven.</p> |  <p>Warming up: An option for dish warming and keeping the prepared meals hot.</p> |
|  <p>Air at 40°C provides the perfect environment for proving yeast type dough mixes. Simply select the function and place dough in the cavity for allotted</p> |  <p>Rapid preheat: The rapid preheat function can be used to reach the selected temperature in just a few minutes.</p> |
|  <p>Sabbath: This function allows you to cook food during the Sabbath, the Holiday of rest in the Jewish religion, respecting the precepts.</p> |  <p>5 The oven cavity has 5 different cooking levels.</p> |
|  <p>Smart Cooking System: for the perfect cooking it is simply necessary choosing the kind and the weight of food and the cooking temperature: any other setting will be established automatically.</p> |  <p>Soft close: all models are equipped with advanced function of smooth closing of the door, which allows the device to close smoothly and quietly.</p> |
|  <p>Telescopic rails: allow you to pull out the dish and check it without having to remove it from the oven entirely.</p> |  <p>Electronic control: Allows you to maintain temperature inside the oven with the precision 2-3 ° C. This enables to cook meals that are very sensitive to temperature changes, such as cakes, souffles, puddings.</p> |
|  <p>Touch controls: Easy to use touch controls allow the appliance to be programmed at the touch of a button.</p> |  <p>Vapor Clean: a simple cleaning function using steam to loosen deposits in the oven cavity.</p> |
|  <p>79lt The capacity indicates the amount of usable space in the oven cavity in litres.</p> |  <p>VIVO screen ...</p> |