

INSTALLATION INSTRUCTIONS

DIMENSIONS

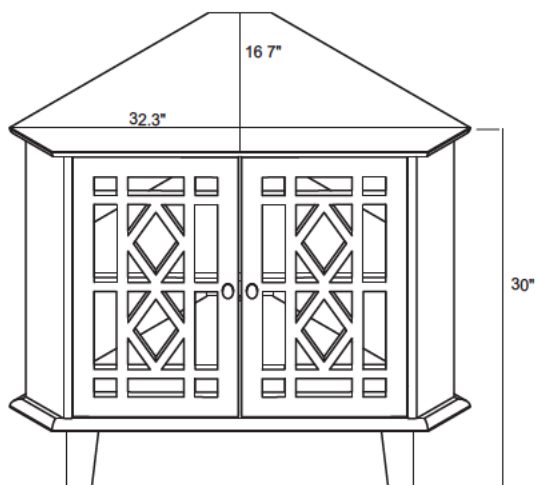





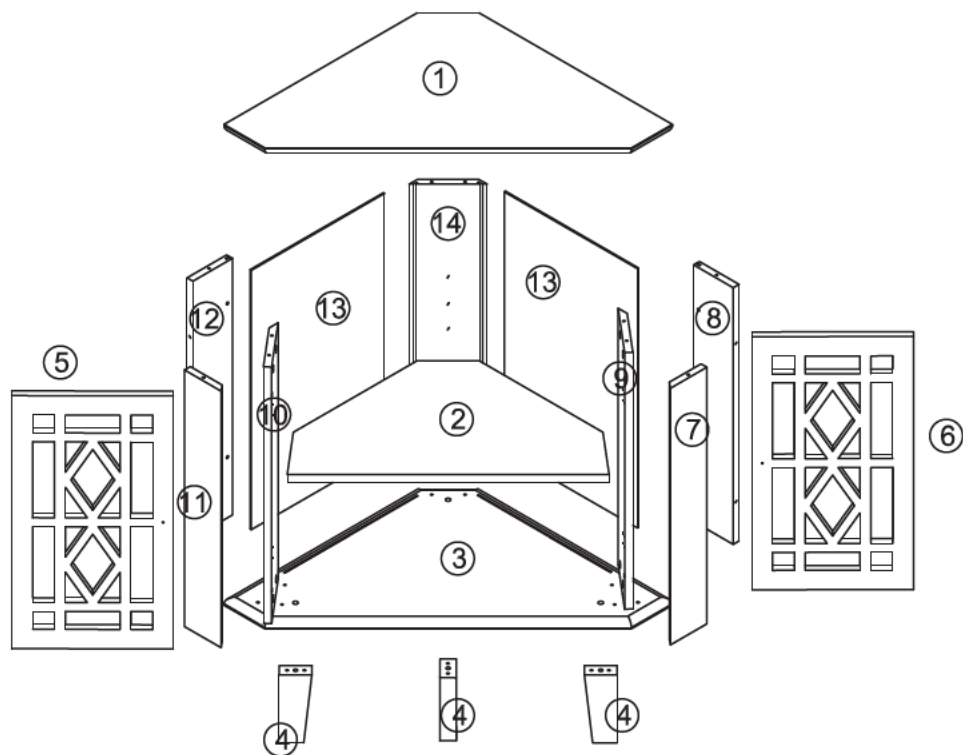



























Unit:inch



ASSEMBLY DIAGRAM

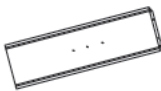

PARTS LIST

PARTS LIST			HARDWARE LIST		
No.	Description	QTY	No.	Description	QTY
1		1	A		20
		1	B		20
2		1	C		6
			D		6
3		1	E		4
			F		24
4		3	G		4
5		1	H		1
			I		8
6		1	J		3
			K		2
7		1	L		2
			M		2
8		1	N		3
			O		1
9		1	P		2
			Q		1
10		1	R		1
			S		1
11		1	T		1
			U		3
12		1			
13		2	14		1

CAUTION: Please confirm the parts list before installation

YOU MAY NEED (NOT SUPPLIED)

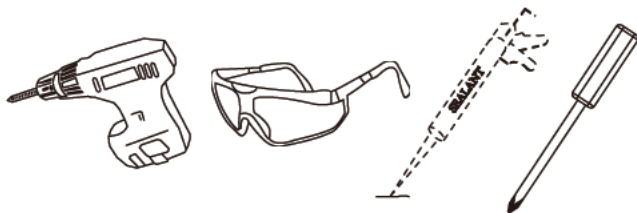



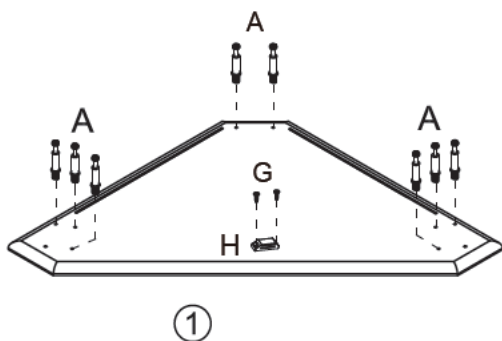
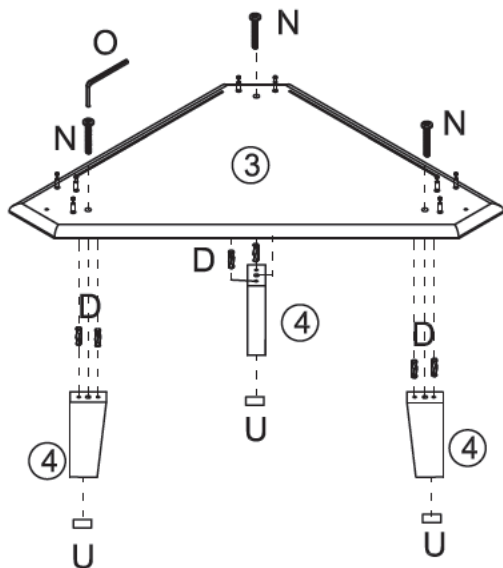
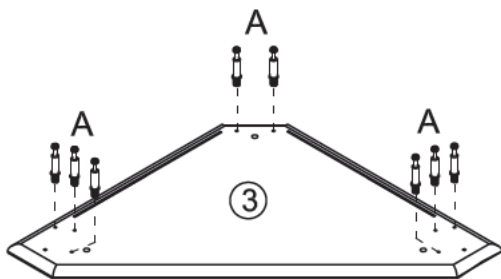

INSTALLATIONS

STEP 1

HARDWARE LIST	
A	16PCS
N	3PCS
D	6PCS
O	1PC
U	3PCS
H	1PC
G	2PCS



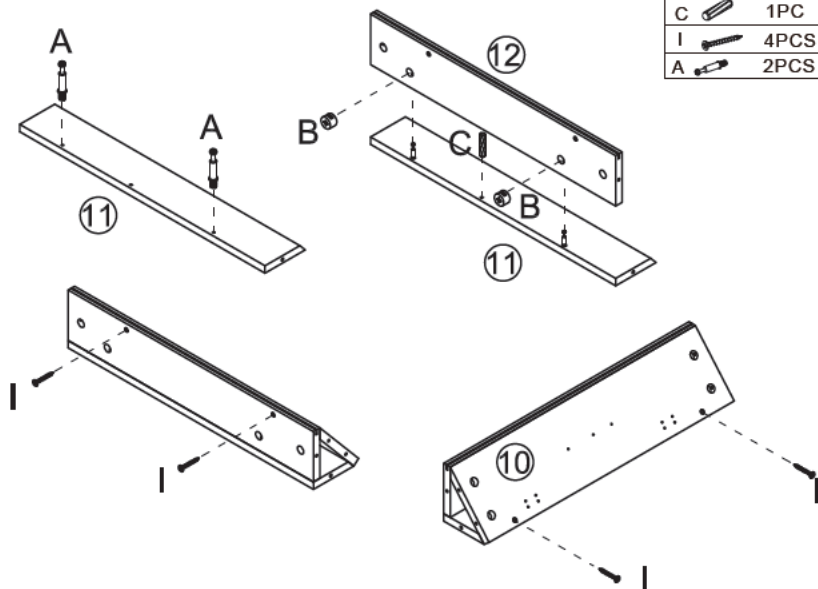

STEP 2

HARDWARE LIST		
B		2PCS
C		1PC
I		4PCS
A		2PCS



STEP 3

HARDWARE LIST		
I		4PCS
B		2PCS
C		1PC
A		2PCS

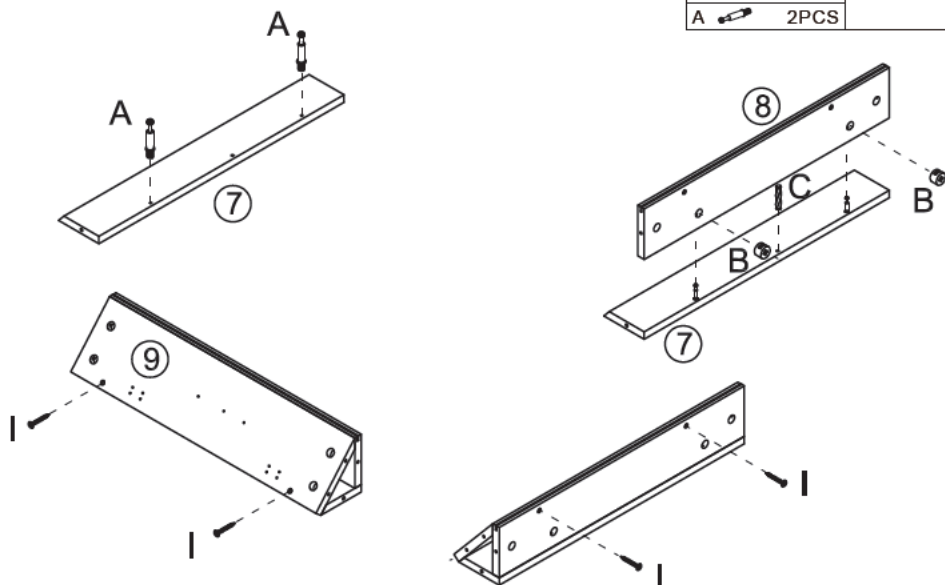

STEP 4

HARDWARE LIST		
C	2PCS	
B	8PCS	

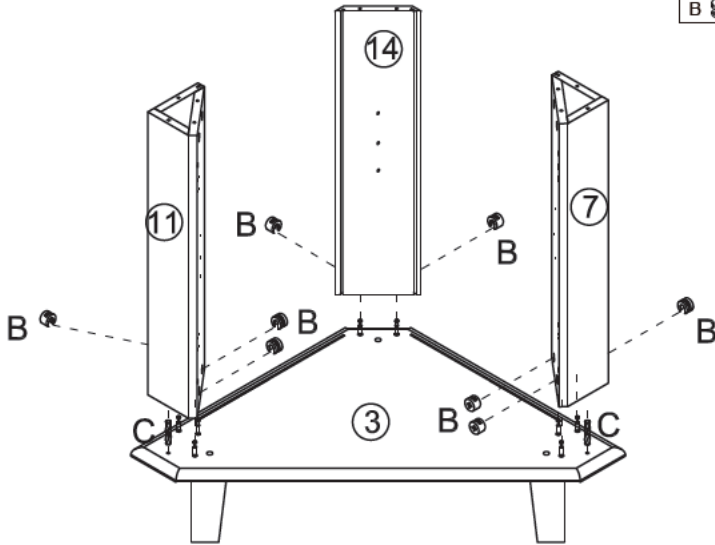

STEP 5

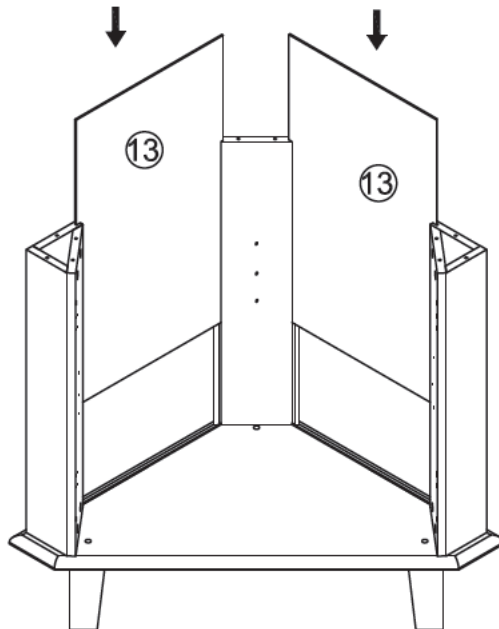

STEP 6

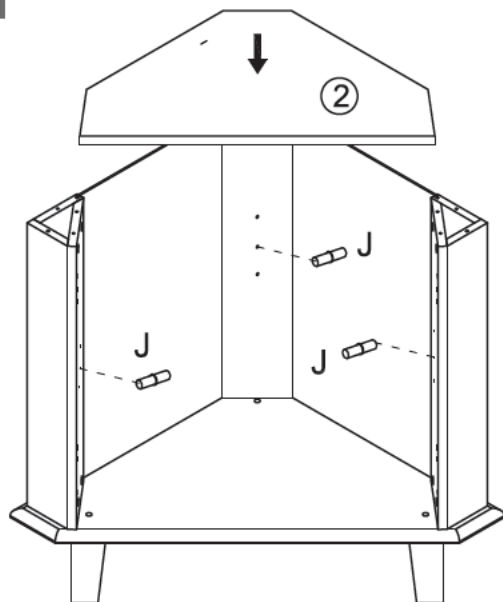

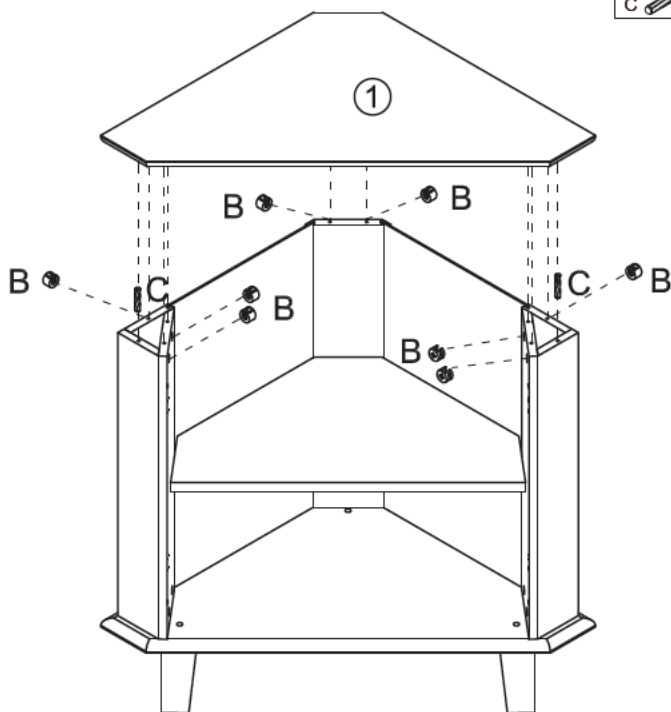

HARDWARE LIST		
J		3PCS
		

STEP 7







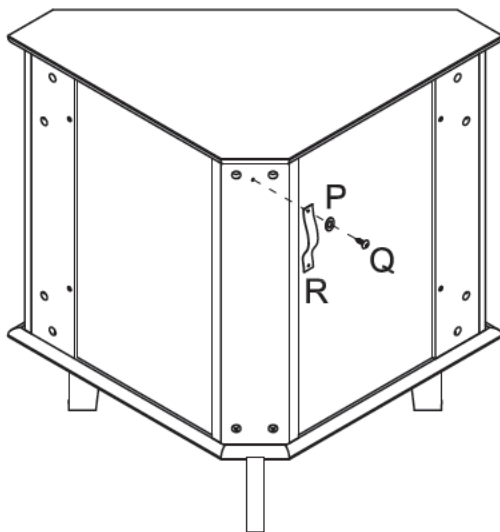

HARDWARE LIST		
B		8PCS
C		2PCS
		

STEP 8

HARDWARE LIST		
P		1PC
Q		1PC
R		1PC

STEP 9

HARDWARE LIST		
E		4PCS
F		8PCS
M		2PCS
L		2PCS
K		2PCS
G		2PCS

STEP 10

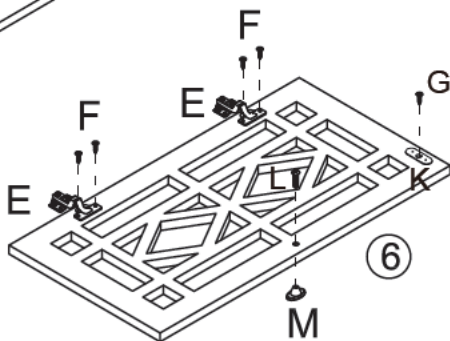
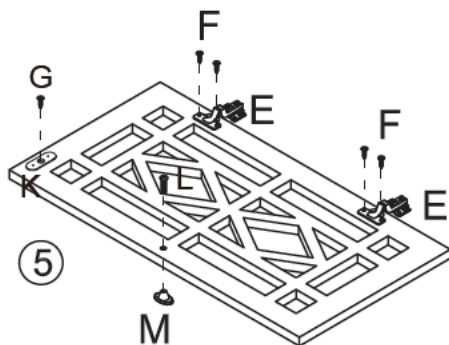
HARDWARE LIST

F  16PCS



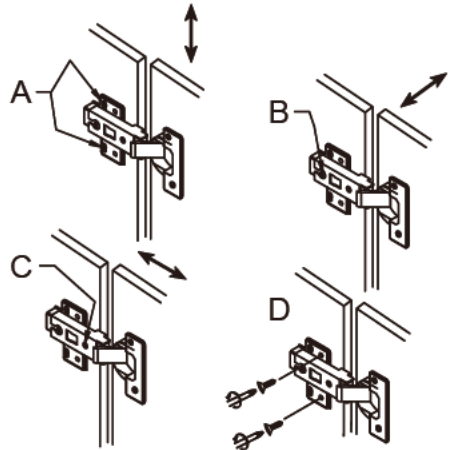
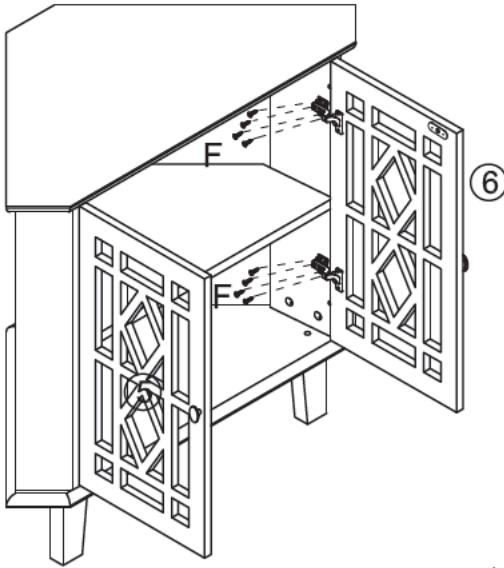



A.Height adjustment C.Side to side adjustment

B.Depth adjustment D.After adjustment A/B/C,tighten screws.

● To ensure proper cabinet alignment, refer to the above illustrations for instructions about adjusting the cabinet height, depth and lateral movement.

STEP 11

HARDWARE LIST		
P		1PC
S		1PC
T		1PC
		

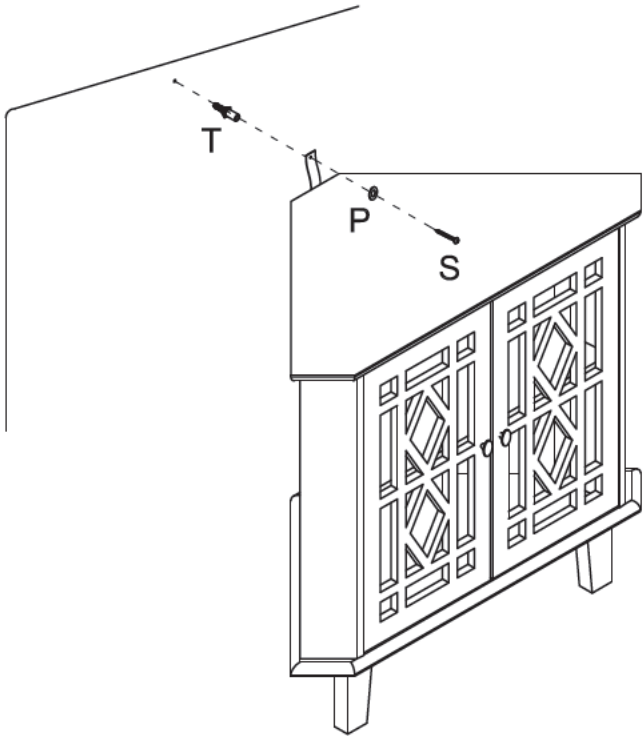

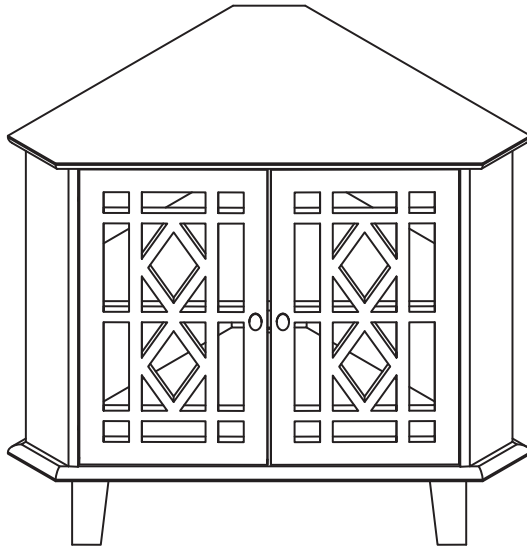

Thank you very much for purchasing from us.

We have always been trying to provide the best service and reliable products for every customer.

However, accident may happen sometimes, please contact us to resolve any issue before leaving a negative feedback.

Many thanks and welcome to our shop again!