

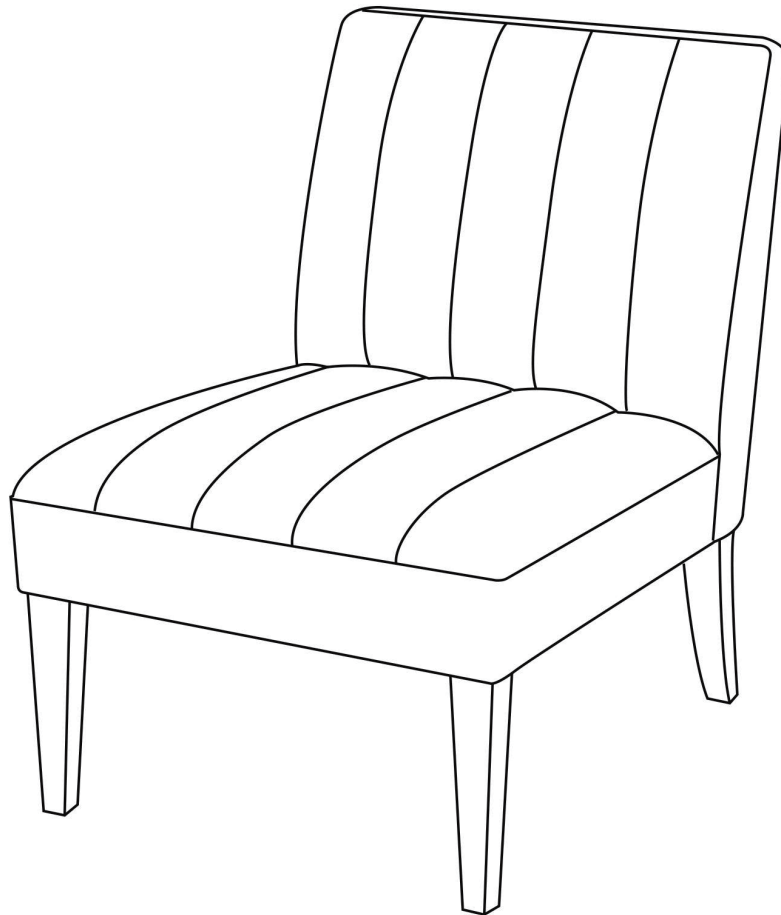



Assembly Manual

Accent Chair

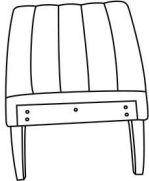
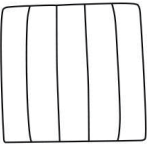
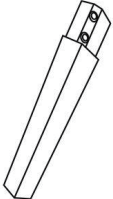
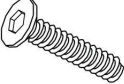

▲ CAUTION

THIS ASSEMBLY MANUAL CONTAINS IMPORTANT SAFETY INFORMATION.
PLEASE READ AND KEEP FOR FUTURE REFERENCE.

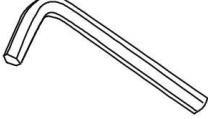
PART	DRAWING	DESCRIPTION	QTY
A		CHAIR BACK	1
B		CHAIR SEAT	1
C		FRONT LEGS	2
H1		LONG BOLT	4
H2		SHORT BOLT	5
H3		LOCK WASHER	9
H4		FLAT WASHER	9
H5		ALLEN KEY	1

ASSEMBLY INSTRUCTIONS

- 1 Please lay the cushion seat on soft, clean surface to assemble.
Use the long bolt (H1) to install the front legs C1/C2 on the cushion (B).

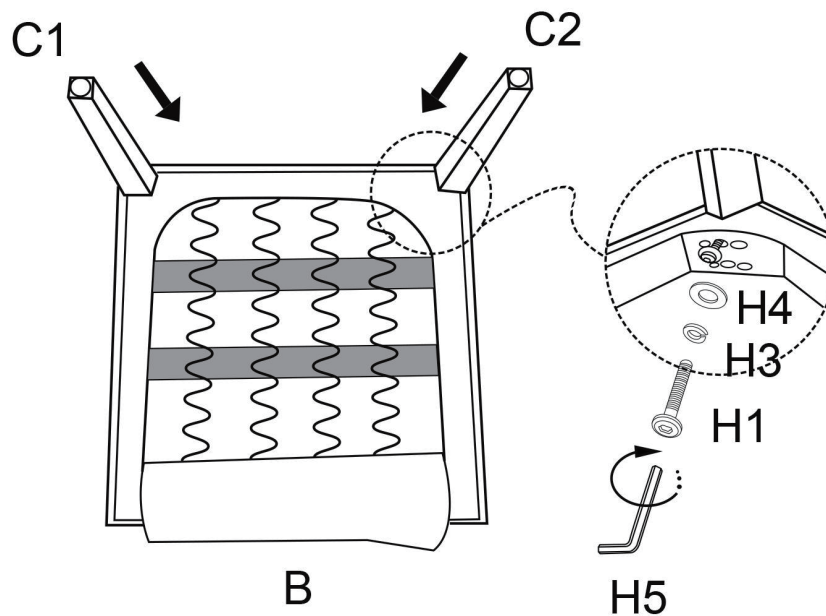

- 2 Put the backrest (A) on a flat surface and use the short bolt (H2) to connect the cushion seat (B). **Note: Do not tighten yet.**

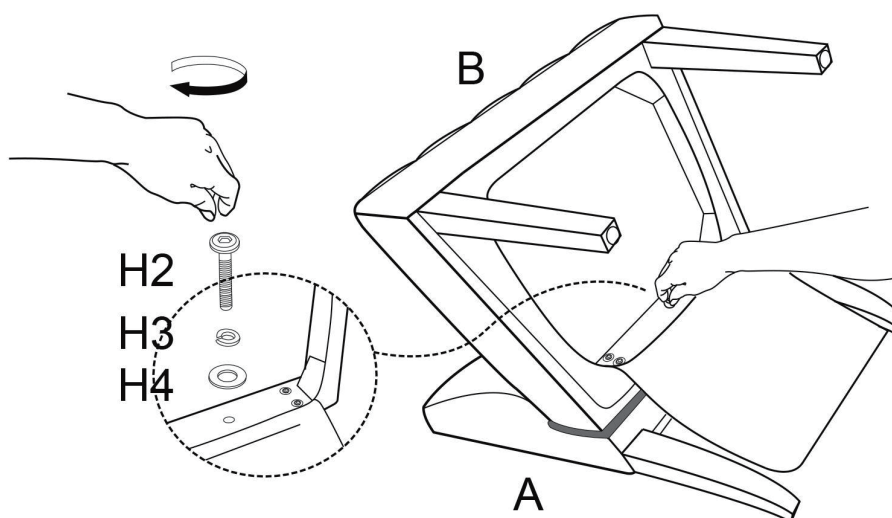

- 3 Press down firmly to make sure all four feet are level with the floor. Finally tighten all bolts with Allen Key(H5).

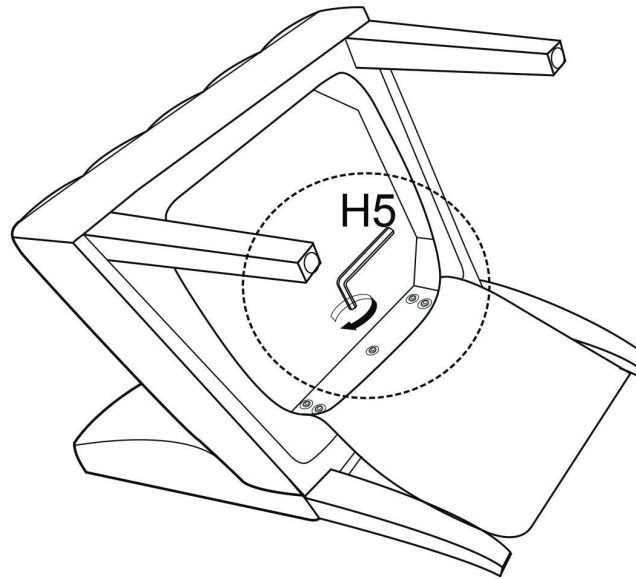
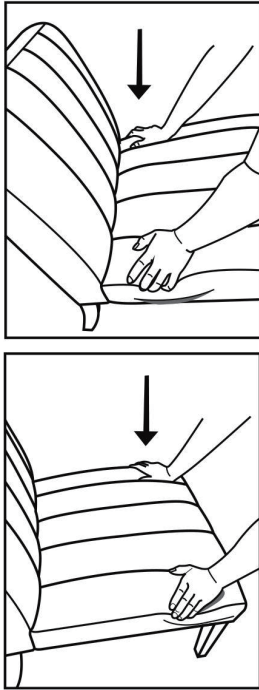

- 4 Assembly complete.

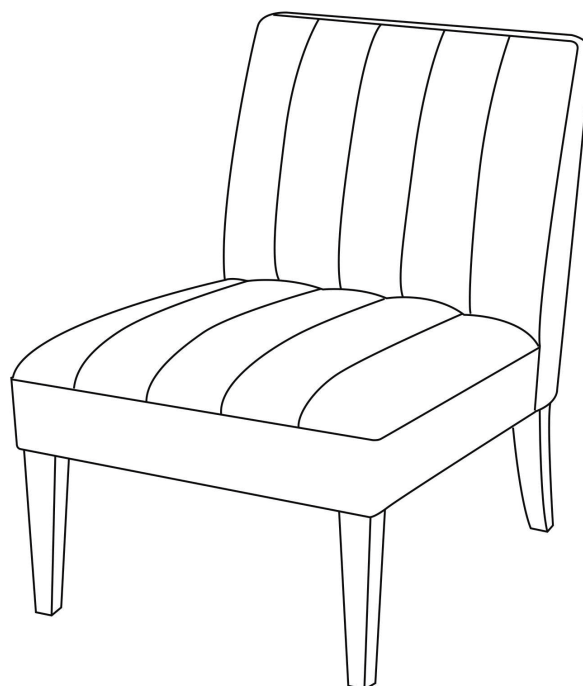

PRODUCT WARRANTY

- 1-year limited on cover against splitting, peeling, and/or tearing.
- 1-year limited on internal and external frame structure.
- 1-year limited on cushioning material, seat springs and mechanism.

CARE & MAINTENANCE

Water Based Cleaner 'W': Spot clean using the foam only from a water-based cleaning agent such as a mild detergent or non-solvent upholstery shampoo product. Apply foam with a soft in circular motion.

Vaccum when dry.

Do not place furniture in direct sunlight and keep furniture at least 60 cm / 2 feet from heat sources to avoid fading.