







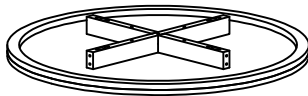

Assembly Instructions

Before assembling, please read this instruction carefully and keep for future reference:

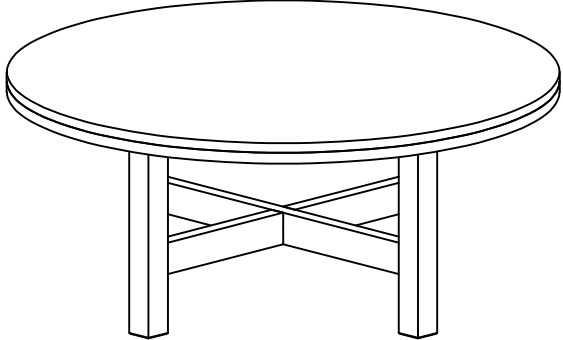
1. Refer to parts inventory for guidance and ensure you have all pieces before start.
2. Please check the condition of all the parts. If any damage or miss parts is found, please contact us immediately.
3. Do not dispose of any packaging or contents of the shipping carton until assembly is completed to avoid accidentally discarding small parts or hardware.
4. Be careful of the heavy board.
5. Handle with care and place all parts on a soft, clean and flat surface such as a carpet to prevent damaging/scratches.
6. Recommended # number of people needed for assembly: 2
7. _____

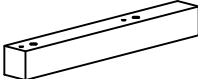
Harmonie Workshop

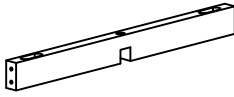
List of parts/hardware:

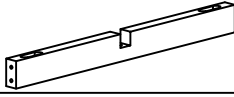
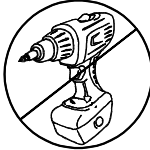
A	TABLE TOP		1 pc	E	ALLEN KEY		1 pc	Finished product 
				F	BOLT 1/4" x 30		1 pc	
B	TABLE LEGS		4 pcs	G	WASHER		1 pc	
				H	FLAT WASHER		1 pc	
C	STRETCHER 1		1 pc	J	BOLT 1/4" x 50		8 pcs	
				K	"C" WASHERS		8 pcs	
D	STRETCHER 1		1 pc					
 <p>NOTICE: DO NOT use the power tools for assembly. This can cause the bolts to be over tightened. DO NOT over tighten hardware, damage may occur.</p>								

Maximum load capacity:

	MAX Load Capacity
Total weight capacity	60 LBS

Disclaimer: Install the Helio Coffee Table unit following instructions provided. We and its related companies are not responsible for injury or damage resulting from incorrect installation or use. Product are for use only as Coffee Table under included MAX Load Capacity and are not designed for any different purposes. Max load capacity only applies when all the legs are installed correctly and stand evenly on the floor.

Installation Steps:

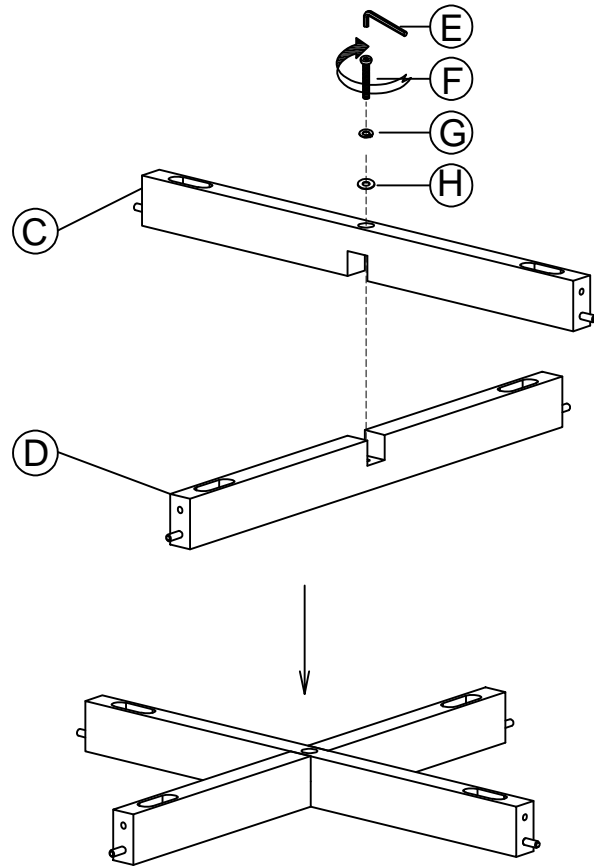

Step 1: Connect the Stretcher together

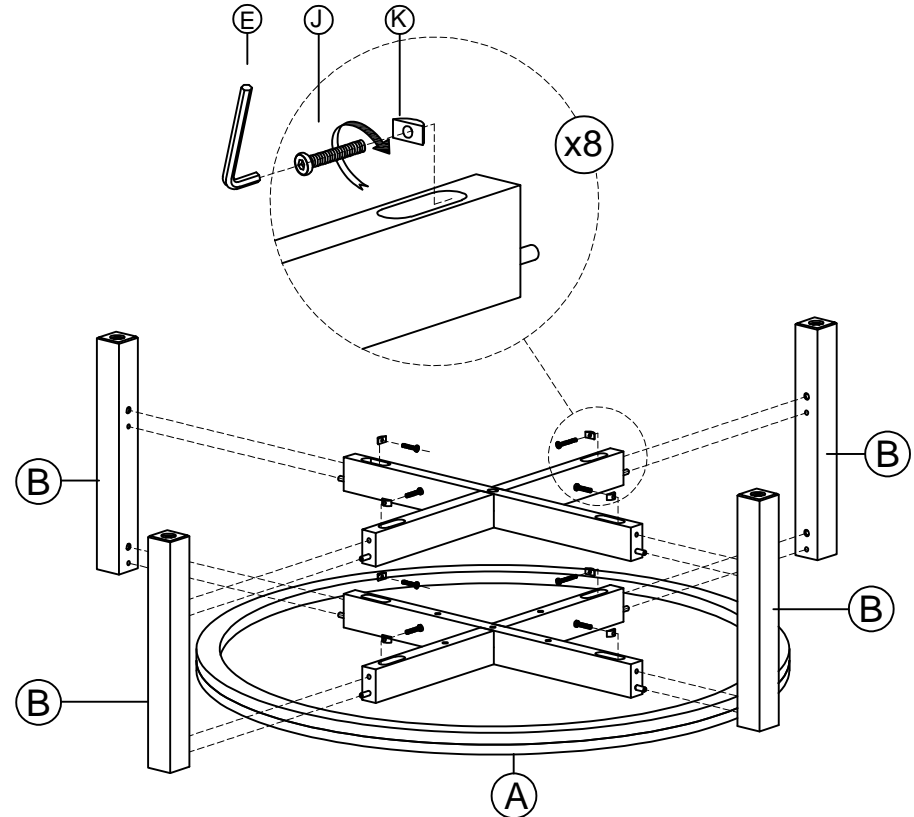

Step 2: Attach four legs and stretchers to table top

Note:

- .Place the table top upside down on the soft surface to avoid scratches.
- .Only tighten the bolts with 80% force at first.
- .After 4 legs have been installed, not tighten the bolts with 100% force.

Harmonie Workshop

Installation Steps:

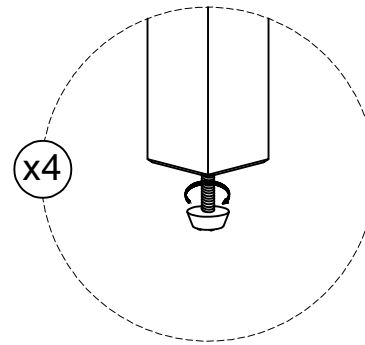
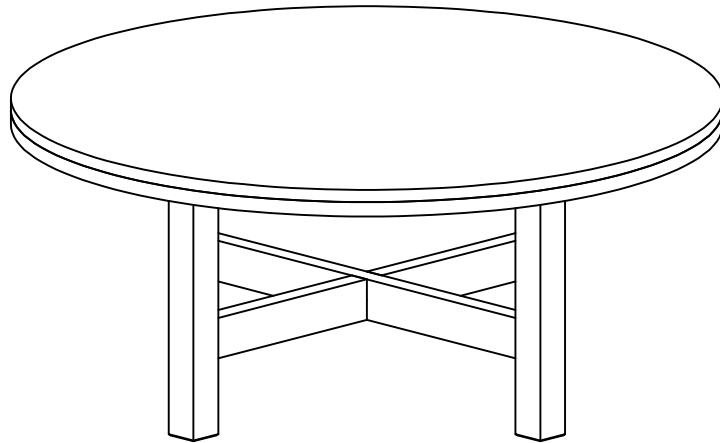

Step 3: Attach levelers to the legs to level the table

Care instructions:

1. Hardware may loosen over time. Periodically check that all connections are tight. Wipe with a soft, dry cloth. To protect finish, avoid the use of chemicals and household cleaners. Any liquid spilled onto the table should be cleaned up immediately with a damp cloth.
2. **Do not** put hot items directly on furniture surface.
3. **Do not** place furniture under direct sunlight.
4. **Do not** place furniture near heating or cooling vents.
5. **Do not** write on furniture without a padded barrier to protect the surface.
6. **Do not** place furniture outside. For indoor use only.
7. **Not** for commercial use. For residential use only.
8. Stains may be removed with mild soap solution and damp cloth.
9. Children **should not** climb or jump on the furniture.