

User Manual

See it - Feel it - Live it

Single Daybed Parts List

A

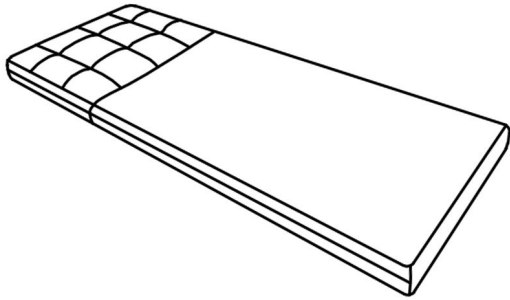

Convertible Chair Bed

B

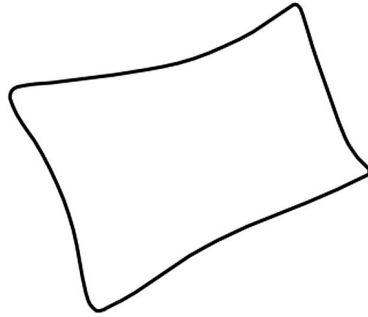

Pillow

C x4

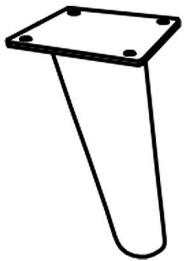

Conical Iron Legs

D x16



Screw

E



Hex Key

Double Daybed Parts List

A

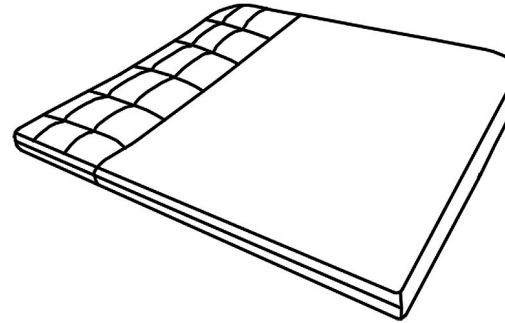

Convertible Chair Bed

B

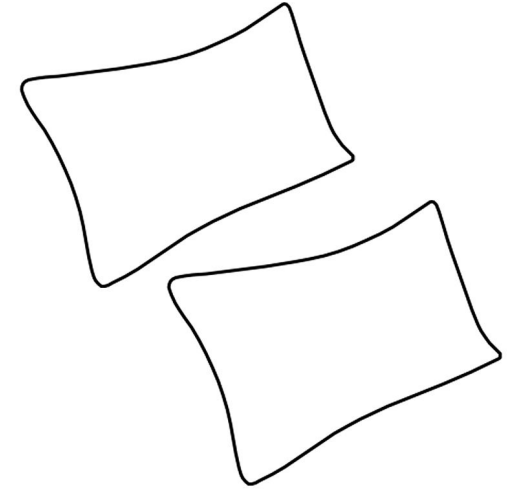

Pillow

C x4

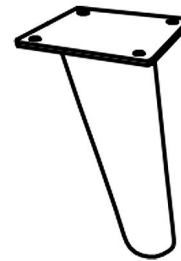

Conical Iron Legs

D x16

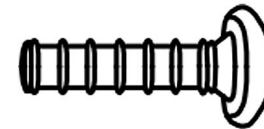

Screw

E



Hex Key

Assembly Instructions - 1

STEP 1

Fix the chair legs with screws

If there are no marked screw holes at the bottom of the seat, simply cut small holes in the black fabric with scissors.

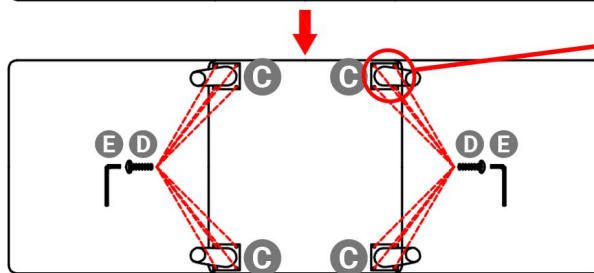
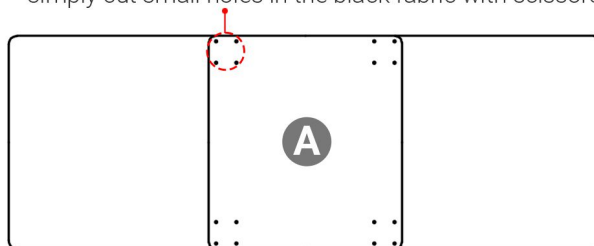

Operate on the four corners simultaneously, insert the screws into the four corners at the same time, tighten them halfway first, then fully tighten all of them.

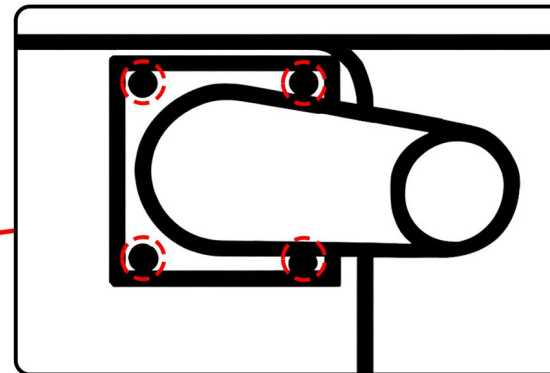

If the screws get stuck and cannot be inserted into the chair legs, simply follow the above instructions. If you do not follow the instructions, unscrewing the screws will cause the paint on the chair legs to peel off!

STEP 2

Operation Instructions for Chair Feet

Unzip the zipper and take out the chair legs

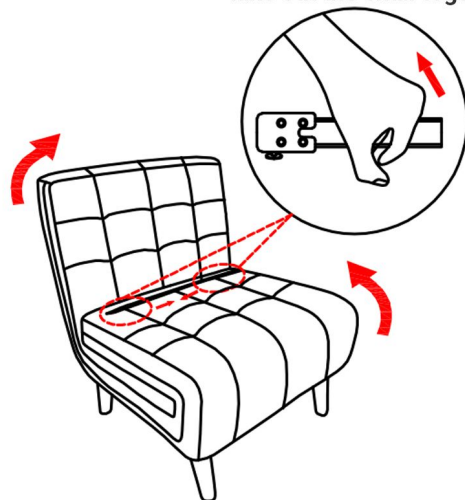

Press and hold the button to retract the chair legs

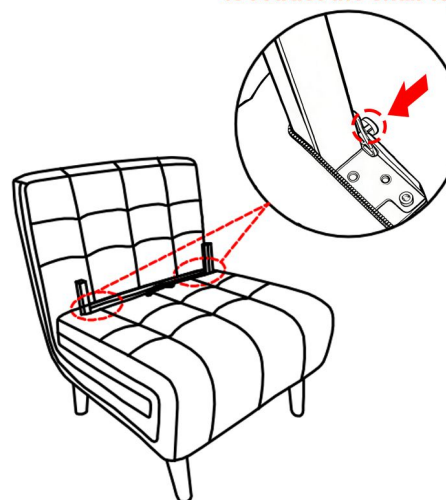

Zip up the zipper

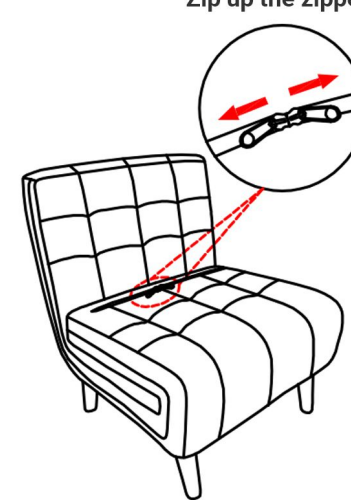

Assembly Instructions - 2

STEP 3

Operation Instructions
for Backrest Feet

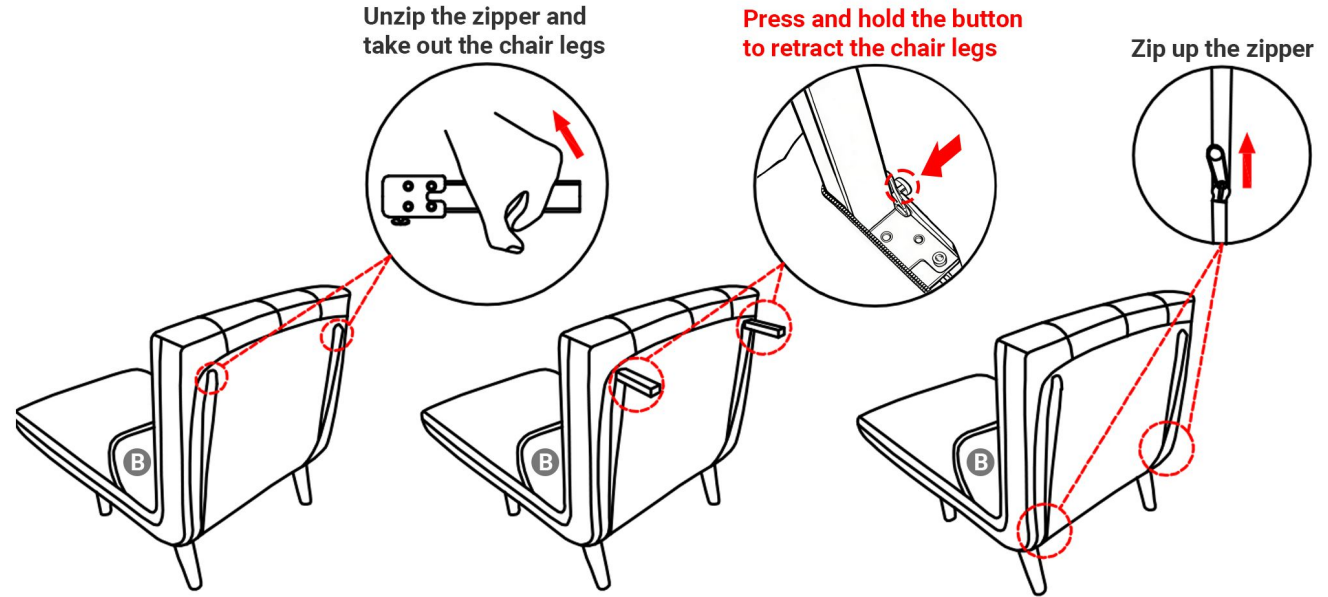

STEP 4

Installation Completed

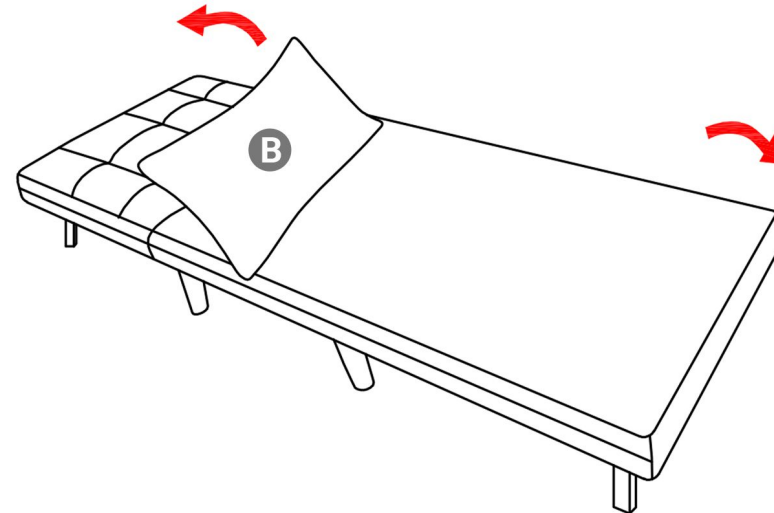

Warning: In the interest of health and safety, Please ensure no obstacles, children or pets are near the chair mechanism or the area Underneath when the chair is in use. This is not a play area. Vigilance is required to avoid accidents.

Single Daybed Display

Chair

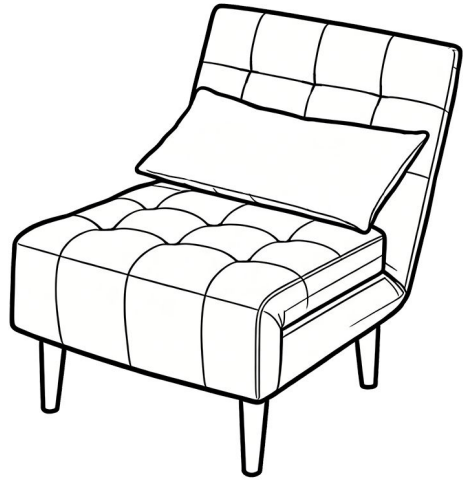

Chaise Longue

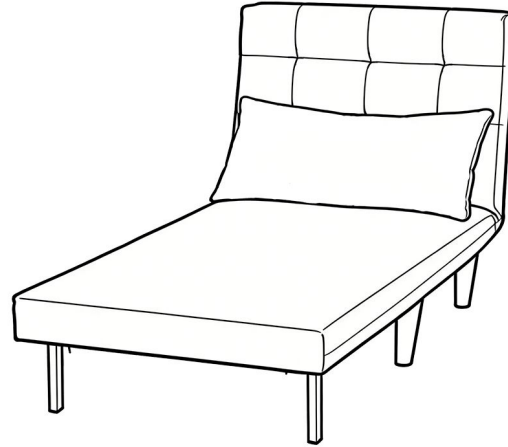

Bed

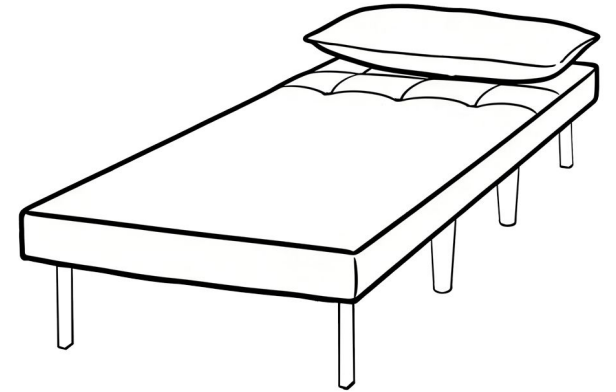

**6-Level
Adjustable Backrest**

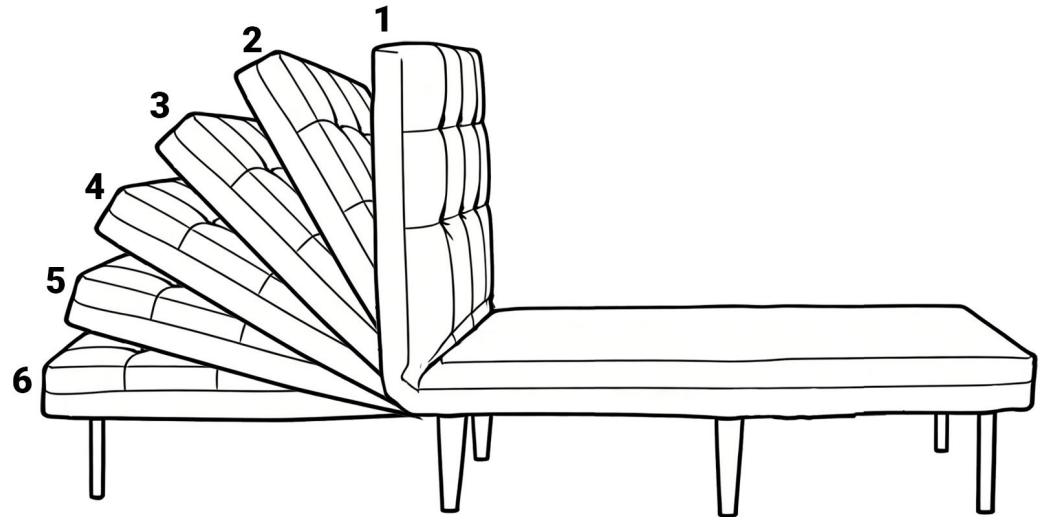

Double Daybed Display

Chair

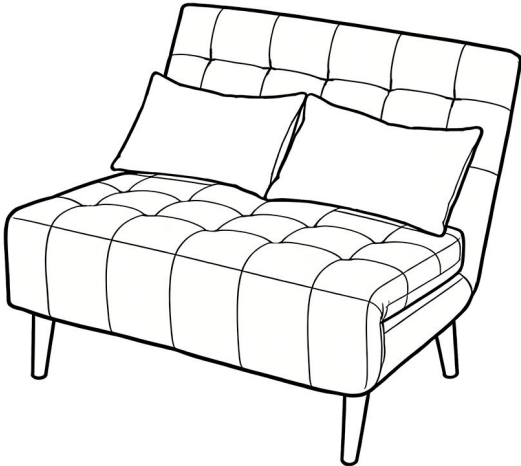

Chaise Longue

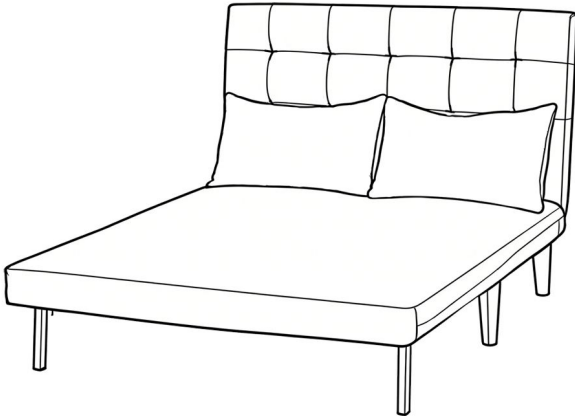

Bed

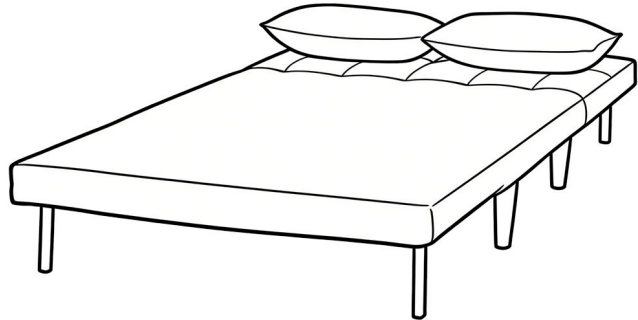

**6-Level
Adjustable Backrest**

