

ASSEMBLY INSTRUCTIONS INSTRUCTIONS DE MONTAGE INSTRUCCIONES DE MONTAJE





DRAWER NIGHTSTAND



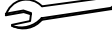

CAUTION: PLEASE READ ALL INSTRUCTIONS BEFORE STARTING THE ASSEMBLY OF THIS PRODUCT. THESE PIECES ARE HEAVY. IN ORDER TO PREVENT PERSONAL INJURY AND ENSURE THAT THIS PRODUCT IS NOT DAMAGED DURING THE ASSEMBLY PROCESS, IT IS STRONGLY RECOMMENDED TO ENLIST THE ASSISTANCE OF ONE OR MORE PERSONS. IN CASE OF EXCESS STAIN, WIPE THE BOTTOM OF THE UNIT BEFORE PLACING ON ANY SURFACE.

ATTENTION: VEUILLEZ LIRE TOUTES LES INSTRUCTIONS AVANT DE COMMENCER L'ASSEMBLAGE DE CE PRODUIT. LES PIECES SONT LOURDES. POUR EVITER TOUTE BLESSURE ET POUR VOUS ASSURER QUE LE PRODUIT N'EST PAS ENDOMMAGE' PENDANT L'ASSEMBLAGE, NOUS VOUS RECOMMANDONS DE FAIRE APPEL A UNE OU PLUSIEURS AUTRES PERSONNES. EN CAS DE TACHE EXCESSIVE, ESSUYEZ LE FOND DE L'UNITE' AVANT LE PLACEMENT SUR N'IMPORTE QUELLE SURFACE.

CUIDADO: FAVOR DE LEER TODAS LAS INSTRUCCIONES ANTES DE ENSAMBLAR SU PRODUCTO, ESTAS. PIEZAS SON PESADAS. PARA PREVENIR HERIDAS PERSONALES Y ASEGURAR QUE SU PRODUCTO NO SEA DAN ADO MIENTRAS ES ENSAMBLADO. SE RECOMIENDA LA ASISTENCIA DE UNA O MAUS PERSONAS.

WARNING: PROTECTIVE GLIDE IS PLACED UNDER EACH LEG OF THE FURNITURE TO RESIST SCRATCHES ON FLOOR SURFACE. SOME FLOOR SURFACES CAN BE EXTRA SENSITIVE TO SCRATCHES AND MARKINGS, IF YOU ARE NOT SURE CONSULT WITH YOUR DEALER. AVERTISSEMENT. LES PIEDS DES MEUBLES SONT MUNIS DE PATINS DESTINES A PROTEGER LE PLANCHER. CERTAINS REVETEMENTS DE SOL PEUVENT ETRE TRES FRAGILES. EN CAS DE DOUTE. CONSULTER LE MARCHAND.

LIST OF PARTS AND HARDWARE / LISTE DES PIÈCES ET DU MATÉRIEL/ LISTA DE PIEZAS Y HARDWARE			
NO#/ NOMBRE/ NÚMERO	DESCRIPTION/ DESCRIPTION/ DESCRIPCIÓN		QUANTITY/ QUANTITÉ/ CANTIDAD
A	BOLT/ BOULON/ TORNILLO $\varnothing 5/16"$ *55mm		8 PCS
B	LOCK WASHER/ RONDELLE DE BLOPAGE/ ARANDELA DE BLOQUEO $\varnothing 5/16"$ *1,8mm		8 PCS
C	FLAT WASHER/ RONDELLE PLATE/ ARANDELA PLANA $\varnothing 5/16"$		8 PCS
D	WRENCH/ CLÉ/LLAVE INGLESA		1 PC
E	LEVELER/ NIVELEUR/ NIVELADOR		2 PCS
F	USB PORT		1 PC

LIST OF PARTS AND HARDWARE / LISTE DES PIÈCES ET DU MATÉRIEL/ LISTA DE PIEZAS Y HARDWARE			
NO#/ NOMBRE/ NÚMERO	DESCRIPTION/ DESCRIPTION/ DESCRIPCIÓN		QUANTITY/ QUANTITÉ/ CANTIDAD
1	CABINET BODY/ CORPS DE CABINET/CUERPO DEL GABINETE		1 PC
2	FRONT LEG/ JAMBE AVANT/ PIERNA FRONTA		2 PCS
3	BACK LEG/ JAMBE ARRIÈ/ PIERNA TRASERA		2 PCS
4	FURNITURE TIPPING RESTRAINT/ SYSTEME ANTIBASCULEMENT/ CONTROL PARA EVITAR VULCOS		1 SET

NOTE:
ASSEMBLE UNIT ON A SOFT SURFACE.
ASSEMBLEZ L'UNITÉ SUR UNE SURFACE MOLLE.
ENSAMBLE LA UNIDAD EN UNA SUPERFICIE PLANA Y SUAVE.

DO NOT TIGHTEN BOLTS UNTIL ALL PARTS AND HARDWARE OF THE UNIT ARE ASSEMBLED.
NE SERREZ PAS LES BOULONS JUSQU'À CE QUE L'UNITÉ SOIT COMPLÈMENT ASSEMBLEE.
NO APRIETE LOS TORNILLOS HASTA QUE LA UNIDAD ESTE COMPLETAMENTE ENSAMBLADA.

ASSEMBLY INSTRUCTIONS INSTRUCTIONS DE MONTAGE INSTRUCCIONES DE MONTAJE

DRAWER NIGHTSTAND

STEP/ ÉTAPE/ PASO 1

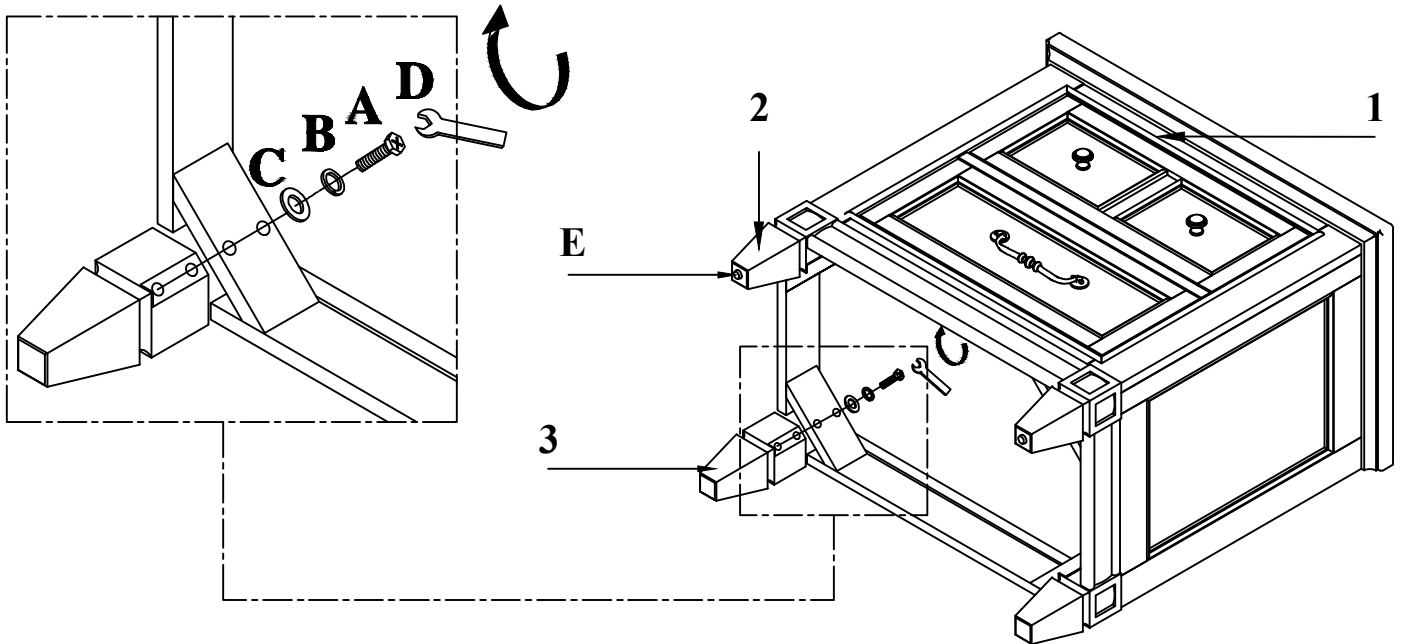

STEP/ ÉTAPE/ PASO 2

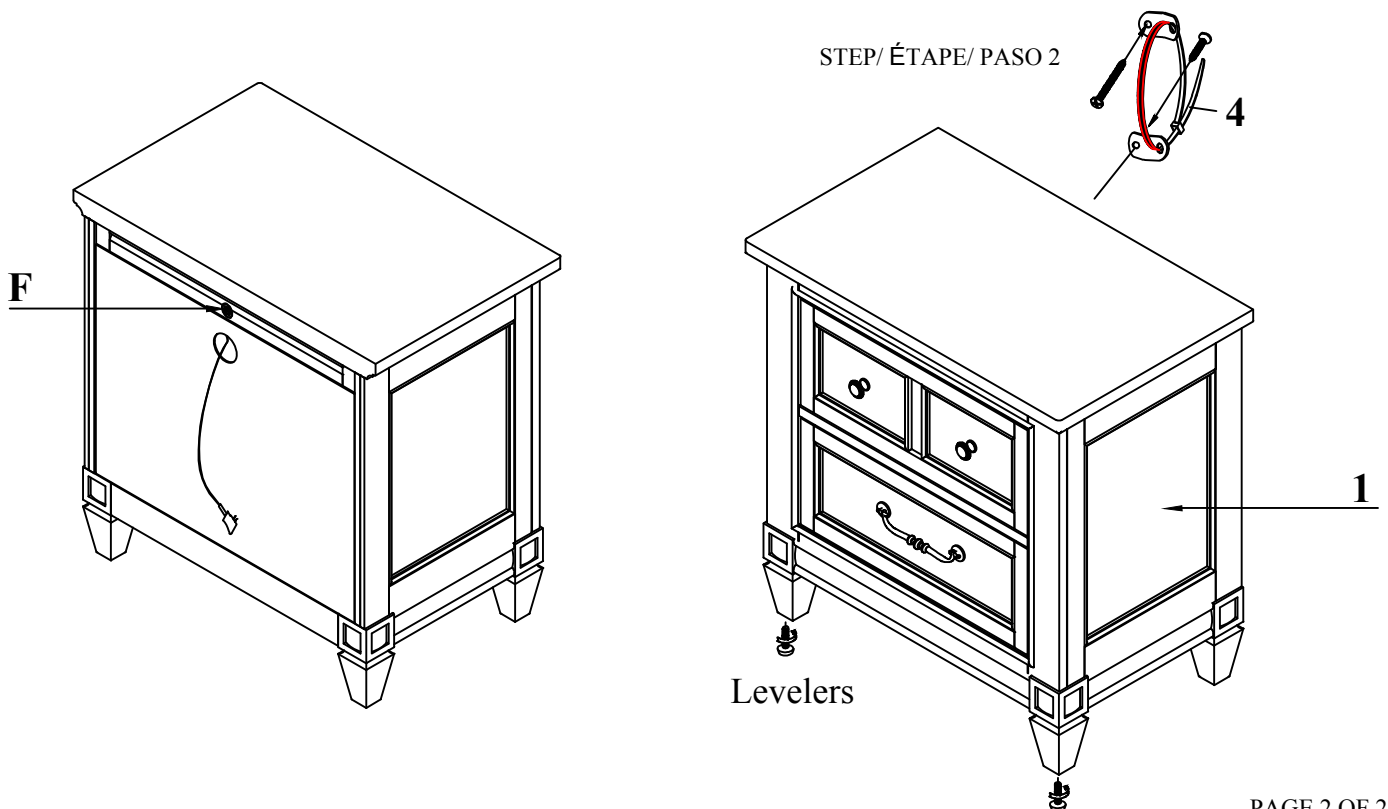

ASSEMBLY INSTRUCTIONS INSTRUCTIONS DE MONTAGE INSTRUCCIONES DE MONTAJE

OPEN NIGHTSTAND





CAUTION: PLEASE READ ALL INSTRUCTIONS BEFORE STARTING THE ASSEMBLY OF THIS PRODUCT. THESE PIECES ARE HEAVY. IN ORDER TO PREVENT PERSONAL INJURY AND ENSURE THAT THIS PRODUCT IS NOT DAMAGED DURING THE ASSEMBLY PROCESS, IT IS STRONGLY RECOMMENDED TO ENLIST THE ASSISTANCE OF ONE OR MORE PERSONS. IN CASE OF EXCESS STAIN, WIPE THE BOTTOM OF THE UNIT BEFORE PLACING ON ANY SURFACE.

ATTENTION: VEUILLEZ LIRE TOUTES LES INSTRUCTIONS AVANT DE COMMENCER L'ASSEMBLAGE DE CE PRODUIT. LES PIÈCES SONT LOURDES. POUR ÉVITER TOUTE BLESSURE ET POUR VOUS ASSURER QUE LE PRODUIT N'EST PAS ENDOMMAGÉ PENDANT L'ASSEMBLAGE, NOUS VOUS RECOMMANDONS DE FAIRE APPEL À UNE OU PLUSIEURS AUTRES PERSONNES. EN CAS DE TACHE EXCESSIVE, ESSUYEZ LE FOND DE L'UNITÉ AVANT LE PLACEMENT SUR N'IMPORTE QUELLE SURFACE.

CUIDADO: FAVOR DE LEER TODAS LAS INSTRUCCIONES ANTES DE ENSAMBLAR SU PRODUCTO, ESTAS PIEZAS SON PESADAS. PARA PREVENIR HERIDAS PERSONALES Y ASEGURAR QUE SU PRODUCTO NO SEA DAÑADO MIENTRAS ES ENSAMBLADO. SE RECOMIENDA LA ASISTENCIA DE UNA O MÁS PERSONAS.

WARNING: PROTECTIVE GLIDE IS PLACED UNDER EACH LEG OF THE FURNITURE TO RESIST SCRATCHES ON FLOOR SURFACE. SOME FLOOR SURFACES CAN BE EXTRA SENSITIVE TO SCRATCHES AND MARKINGS, IF YOU ARE NOT SURE CONSULT WITH YOUR DEALER. AVERTISSEMENT. LES PIEDS DES MEUBLES SONT MUNIS DE PATINS DESTINÉS À PROTÉGER LE PLANCHER. CERTAINS REVÊTEMENTS DE SOL PEUVENT ÊTRE TRÈS FRAGILES. EN CAS DE DOUTE, CONSULTEZ LE MARCHAND.

LIST OF PARTS AND HARDWARE/ LISTE DES PIÈCES ET DU MATÉRIEL/ LISTA DE PIEZAS Y HARDWARE			
NO#/ NOMBRE/ NÚMERO	DESCRIPTION/ DESCRIPTION/ DESCRIPCIÓN		QUANTITY/ QUANTITÉ/ CANTIDAD
A	BOLT/ BOULON/ TORNILLO $\Phi 5/16 \times 55\text{mm}$		8 PCS
B	LOCK WASHER/ RONDELLE DE BLOCAGE/ ARANDELA DE BLOQUEO $\Phi 5/16 \times 1,8\text{mm}$		8 PCS
C	FLAT WASHER/ RONDELLE PLATE/ ARANDELA PLANA $\Phi 5/16"$		8 PCS
D	WRENCH/ CLÉ/ Llave inglesa		1 PC
E	LEVELER/NIVELEUR/NIVELADOR		4 PCS
F	SCREW/VIS/TORNILLO #8*32mm		8 PCS
G	USB PORT		1 PC

LIST OF PARTS AND HARDWARE/ LISTE DES PIÈCES ET DU MATÉRIEL/ LISTA DE PIEZAS Y HARDWARE			
NO#/ NOMBRE/ NÚMERO	DESCRIPTION/ DESCRIPTION/ DESCRIPCIÓN		QUANTITY/ QUANTITÉ/ CANTIDAD
1	CABINET BODY/ CORPS DE CABINET/ CUERPO DEL GABINETE		1 PC
2	LEG/ JAMBE/ PIERNA		4 PCS
3	Top shelf / Repiza superior / Tablette du haut		1 PC
4	BOTTOM SHELF/ ÉTAGÈRE INFÉRIEURE/ ESTANTE INFERIOR		1 PC
5	FURNITURE TIPPING RESTRAINT/ SYSTEME ANTIBASCULEMENT/ CONTROL PARA EVITAR VULCOS		1 SET

NOTE:
ASSEMBLE UNIT ON A SOFT SURFACE.
ASSEMBLEZ L'UNITÉ SUR UNE SURFACE MOLLE.
ENSAMBLE LA UNIDAD EN UNA SUPERFICIE PLANA Y SUAVE.

DO NOT TIGHTEN BOLTS UNTIL THE UNIT IS COMPLETELY ASSEMBLED.
NE SERREZ PAS LES BOULONS JUSQU'À CE QUE L'UNITÉ SOIT COMPLÈTEMENT ASSEMBLÉE.
NO APRIETE LOS TORNILLOS HASTA QUE LA UNIDAD ESTE COMPLETAMENTE ENSAMBLADA.

ASSEMBLY INSTRUCTIONS INSTRUCTIONS DE MONTAGE INSTRUCCIONES DE MONTAJE

OPEN NIGHTSTAND

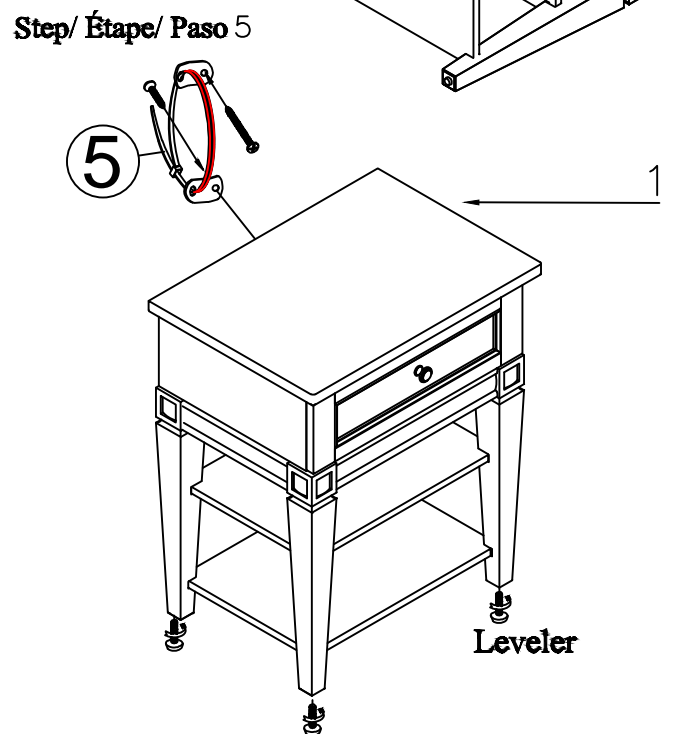
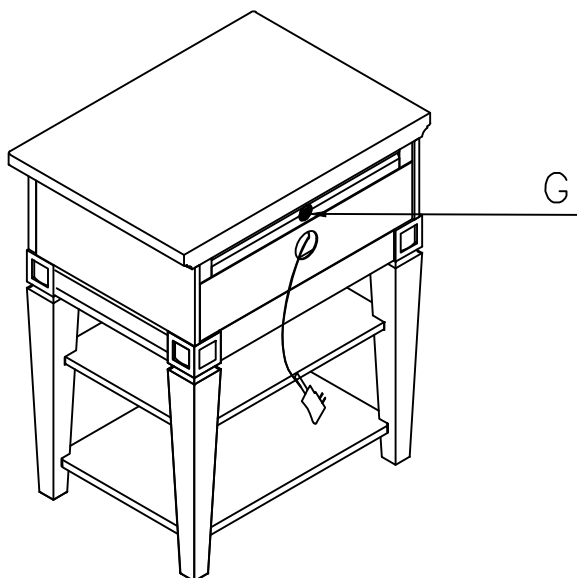
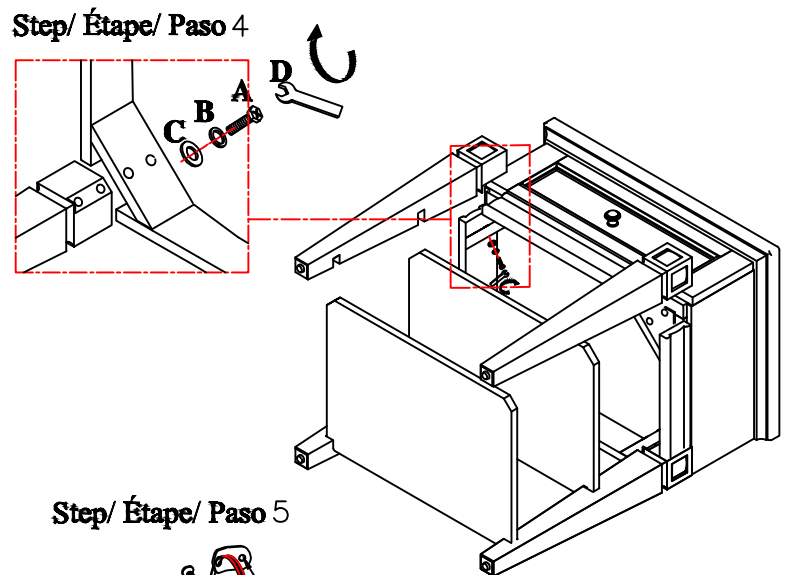
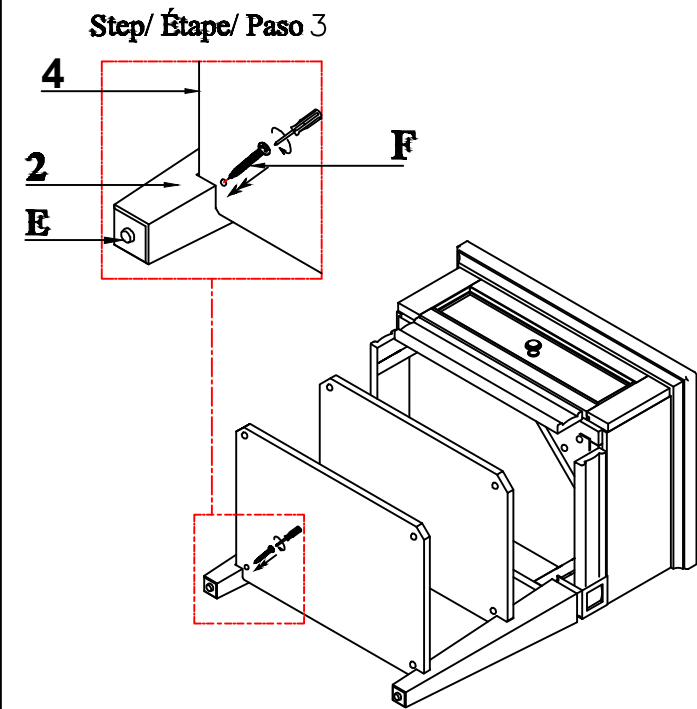
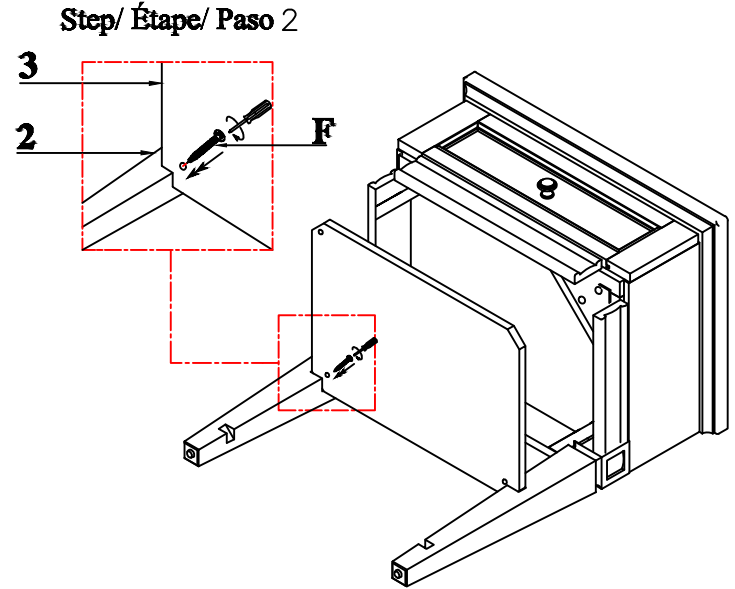
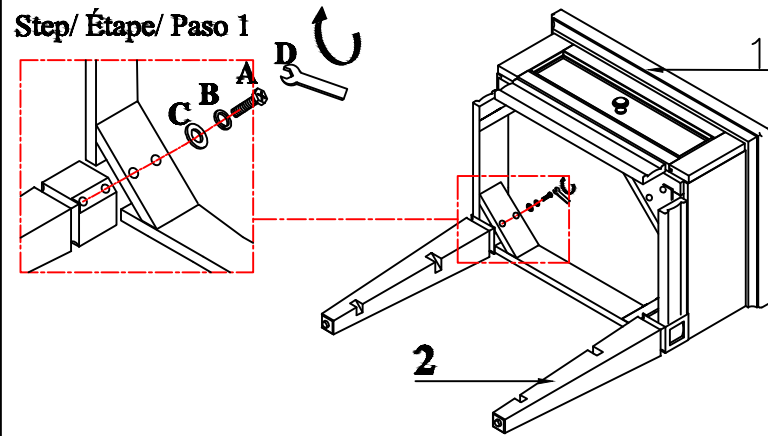

ASSEMBLY INSTRUCTIONS INSTRUCTIONS DE MONTAGE INSTRUCCIONES DE MONTAJE

OPEN NIGHTSTAND





CAUTION: PLEASE READ ALL INSTRUCTIONS BEFORE STARTING THE ASSEMBLY OF THIS PRODUCT. THESE PIECES ARE HEAVY. IN ORDER TO PREVENT PERSONAL INJURY AND ENSURE THAT THIS PRODUCT IS NOT DAMAGED DURING THE ASSEMBLY PROCESS, IT IS STRONGLY RECOMMENDED TO ENLIST THE ASSISTANCE OF ONE OR MORE PERSONS. IN CASE OF EXCESS STAIN, WIPE THE BOTTOM OF THE UNIT BEFORE PLACING ON ANY SURFACE.

ATTENTION: VEUILLEZ LIRE TOUTES LES INSTRUCTIONS AVANT DE COMMENCER L'ASSEMBLAGE DE CE PRODUIT. LES PIÈCES SONT LOURDES. POUR ÉVITER TOUTE BLESSURE ET POUR VOUS ASSURER QUE LE PRODUIT N'EST PAS ENDOMMAGÉ PENDANT L'ASSEMBLAGE, NOUS VOUS RECOMMANDONS DE FAIRE APPEL À UNE OU PLUSIEURS AUTRES PERSONNES. EN CAS DE TACHE EXCESSIVE, ESSUYEZ LE FOND DE L'UNITÉ AVANT LE PLACEMENT SUR N'IMPORTE QUELLE SURFACE.





CUIDADO: FAVOR DE LEER TODAS LAS INSTRUCCIONES ANTES DE ENSAMBLAR SU PRODUCTO. ESTAS PIEZAS SON PESADAS. PARA PREVENIR HERIDAS PERSONALES Y ASEGURAR QUE SU PRODUCTO NO SEA DAÑADO MIENTRAS ES ENSAMBLADO, SE RECOMIENDA LA ASISTENCIA DE UNA O MÁS PERSONAS.

WARNING: PROTECTIVE GLIDE IS PLACED UNDER EACH LEG OF THE FURNITURE TO RESIST SCRATCHES ON FLOOR SURFACE. SOME FLOOR SURFACES CAN BE EXTRA SENSITIVE TO SCRATCHES AND MARKINGS, IF YOU ARE NOT SURE CONSULT WITH YOUR DEALER. AVERTISSEMENT. LES PIEDS DES MEUBLES SONT MUNIS DE PATINS DESTINÉS À PROTÉGER LE PLANCHER. CERTAINS REVÊTEMENTS DE SOL PEUVENT ÊTRE TRÈS FRAGILES. EN CAS DE DOUTE, CONSULTEZ LE MARCHAND.

LIST OF PARTS AND HARDWARE/ LISTE DES PIÈCES ET DU MATÉRIEL/ LISTA DE PIEZAS Y HARDWARE

NO#/ NOMBRE/ NÚMERO	DESCRIPTION/ DESCRIPTION/ DESCRIPCIÓN		QUANTITY/ QUANTITÉ/ CANTIDAD
A	LEVELER/NIVÉLEUR/NIVELADOR		4 PCS
B	USB PORT		1 PC
C	SCREW/VIS/TORNILLO #8*25mm		6 PCS
D	Metal Bracket		2 PCS

LIST OF PARTS AND HARDWARE/ LISTE DES PIÈCES ET DU MATÉRIEL/ LISTA DE PIEZAS Y HARDWARE

NO#/ NOMBRE/ NÚMERO	DESCRIPTION/ DESCRIPTION/ DESCRIPCIÓN		QUANTITY/ QUANTITÉ/ CANTIDAD
1			1 PC
2	L L DEL L		1 PC
3	ABINE B D P DE ABINE E P DEL GABINE E		1 PC
4	FURNITURE TIPPING RESTRAINT/ SYSTEME ANTIBASCULEMENT/ CONTROL PARA EVITAR VULCOS		1 SET
5	HEADBOARD PANEL/ PANNEAU DE TÊTE DE LI / PANEL DE CABECEIRA		1 PC

NOTE:

ASSEMBLE UNIT ON A SOFT SURFACE.

ASSEMBLEZ L'UNITÉ SUR UNE SURFACE MOLLE.

ENSAMBLE LA UNIDAD EN UNA SUPERFICIE PLANA Y SUAVE.

DO NOT TIGHTEN BOLTS UNTIL THE UNIT IS COMPLETELY ASSEMBLED.

NE SERREZ PAS LES BOULONS JUSQU'À CE QUE L'UNITÉ SOIT COMPLÈTEMENT ASSEMBLÉE.

NO APRIETE LOS TORNILLOS HASTA QUE LA UNIDAD ESTE COMPLETAMENTE ENSAMBLADA.

ASSEMBLY INSTRUCTIONS INSTRUCTIONS DE MONTAGE INSTRUCCIONES DE MONTAJE

OPEN NIGHTSTAND

Step/ Étape/ Paso 1

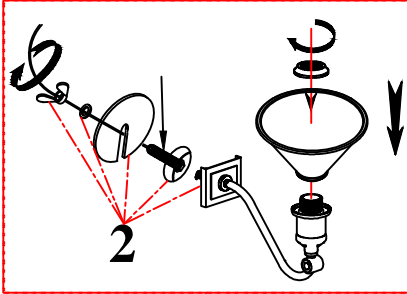

Step/ Étape/ Paso 2

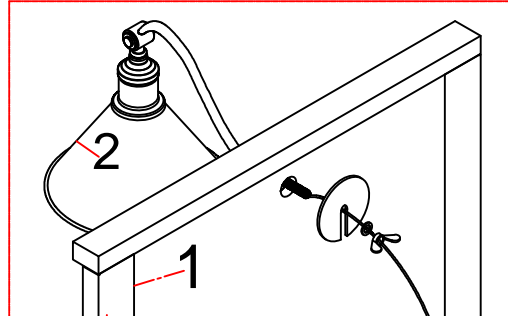

Step/ Étape/ Paso 3

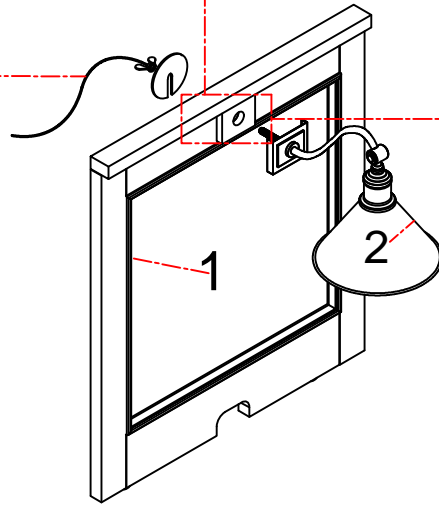
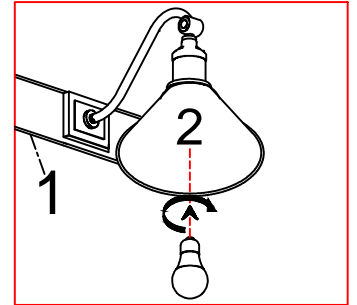

Step/ Étape/ Paso 4

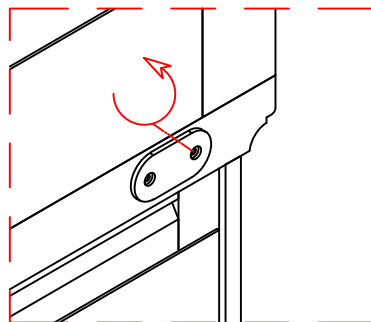

Step/ Étape/ Paso 5

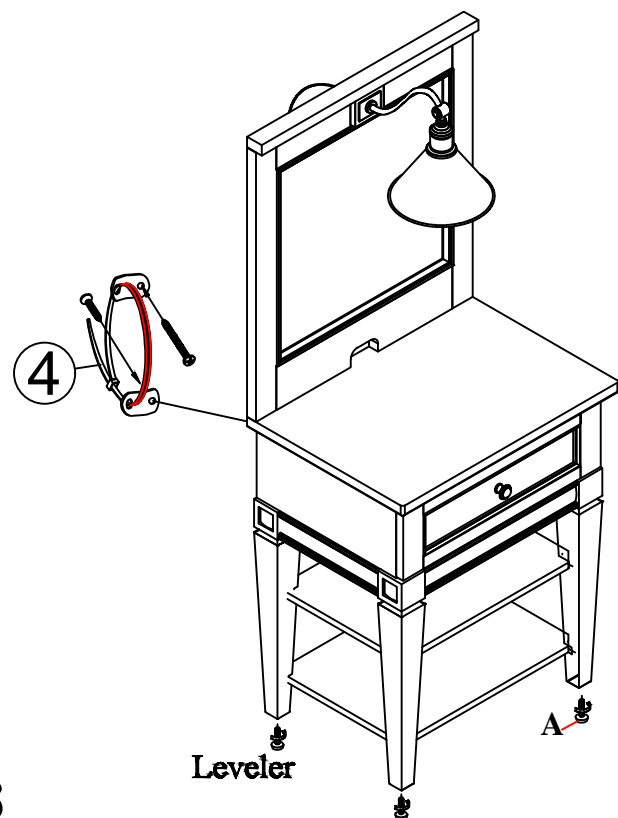
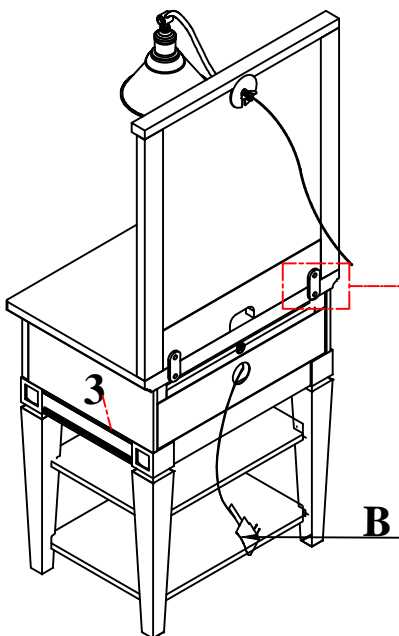
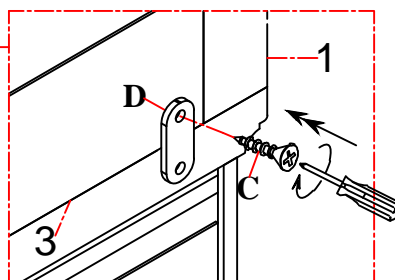

ASSEMBLY INSTRUCTIONS INSTRUCTIONS DE MONTAGE INSTRUCCIONES DE MONTAJE

OPEN NIGHTSTAND

Step/ Étape/ Paso 6

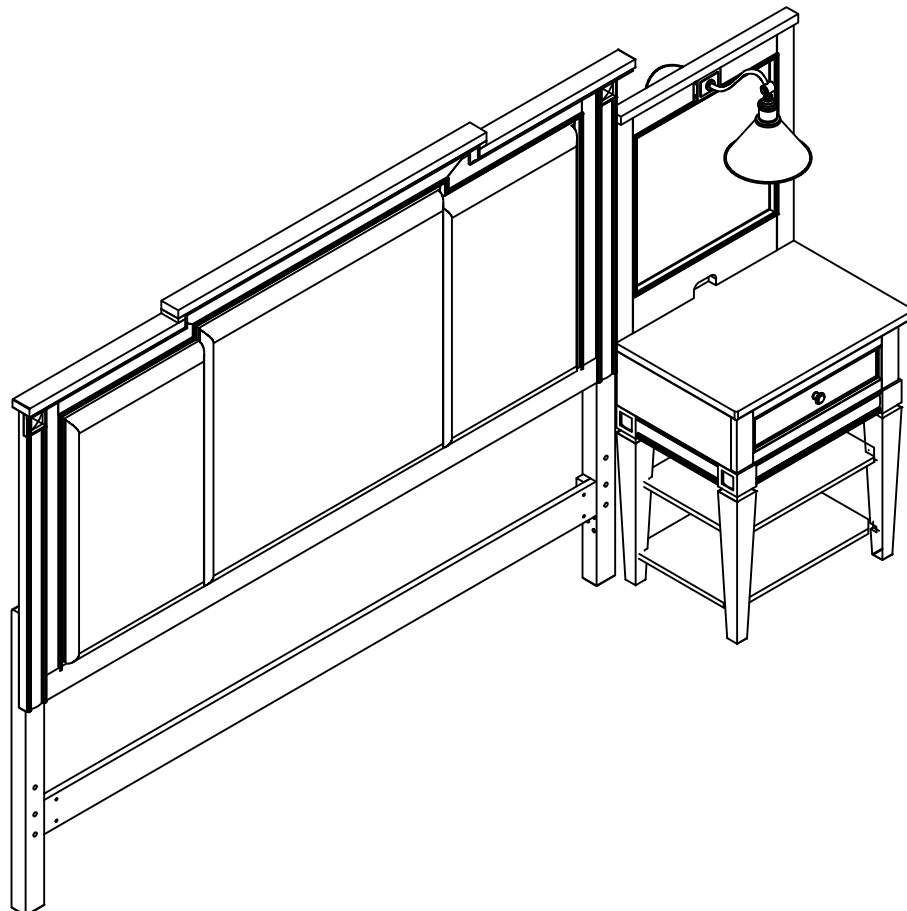
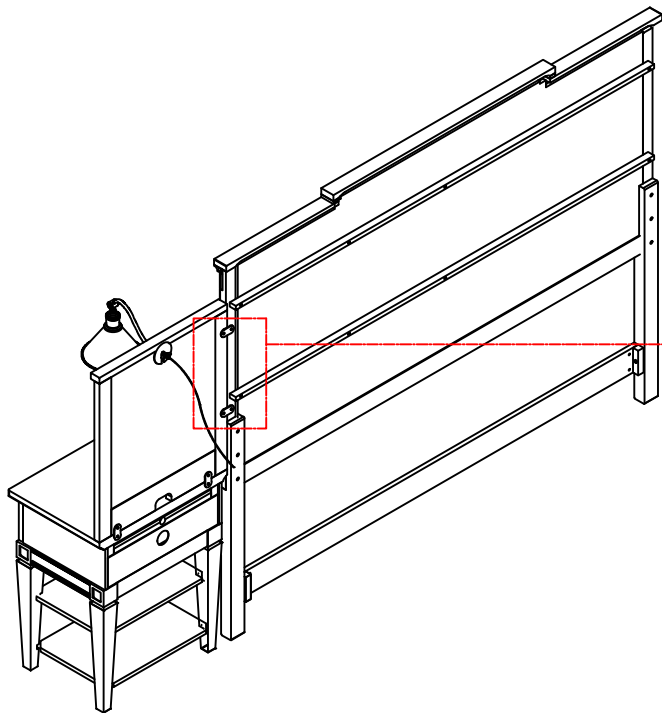
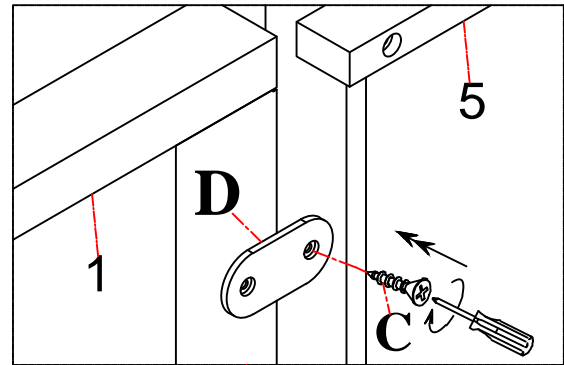

ASSEMBLY INSTRUCTIONS INSTRUCTIONS DE MONTAGE INSTRUCCIONES DE MONTAJE





DRAWER CHEST



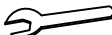

CAUTION: PLEASE READ ALL INSTRUCTIONS BEFORE STARTING THE ASSEMBLY OF THIS PRODUCT. THESE PIECES ARE HEAVY. IN ORDER TO PREVENT PERSONAL INJURY AND ENSURE THAT THIS PRODUCT IS NOT DAMAGED DURING THE ASSEMBLY PROCESS, IT IS STRONGLY RECOMMENDED TO ENLIST THE ASSISTANCE OF ONE OR MORE PERSONS. IN CASE OF EXCESS STAIN, WIPE THE BOTTOM OF THE UNIT BEFORE PLACING ON ANY SURFACE.

ATTENTION: VEUILLEZ LIRE TOUTES LES INSTRUCTIONS AVANT DE COMMENCER L'ASSEMBLAGE DE CE PRODUIT. LES PIECES SONT LOURDES. POUR EVITER TOUTE BLESSURE ET POUR VOUS ASSURER QUE LE PRODUIT N'EST PAS ENDOMMAGE' PENDANT L'ASSEMBLAGE, NOUS VOUS RECOMMANDONS DE FAIRE APPEL A UNE OU PLUSIEURS AUTRES PERSONNES. EN CAS DE TACHE EXCESSIVE, ESSUYEZ LE FOND DE L'UNITE' AVANT LE PLACEMENT SUR N'IMPORTE QUELLE SURFACE.

CUIDADO: FAVOR DE LEER TODAS LAS INSTRUCCIONES ANTES DE ENSAMBLAR SU PRODUCTO, ESTAS. PIEZAS SON PESADAS. PARA PREVENIR HERIDAS PERSONALES Y ASEGURAR QUE SU PRODUCTO NO SEA DAN ADO MIENTRAS ES ENSAMBLADO. SE RECOMIENDA LA ASISTENCIA DE UNA O MAUS PERSONAS.

WARNING: PROTECTIVE GLIDE IS PLACED UNDER EACH LEG OF THE FURNITURE TO RESIST SCRATCHES ON FLOOR SURFACE. SOME FLOOR SURFACES CAN BE EXTRA SENSITIVE TO SCRATCHES AND MARKINGS, IF YOU ARE NOT SURE CONSULT WITH YOUR DEALER. AVERTISSEMENT. LES PIEDS DES MEUBLES SONT MUNIS DE PATINS DESTINES A PROTEGER LE PLANCHER. CERTAINS REVETEMENTS DE SOL PEUVENT ETRE TRES FRAGILES. EN CAS DE DOUTE. CONSULTER LE MARCHAND.

LIST OF PARTS AND HARDWARE / LISTE DES PIÈCES ET DU MATÉRIEL/ LISTA DE PIEZAS Y HARDWARE			
NO#/ NOMBRE/ NÚMERO	DESCRIPTION/ DESCRIPTION/ DESCRIPCIÓN		QUANTITY/ QUANTITÉ/ CANTIDAD
A	BOLT/ BOULON/ TORNILLO $\varnothing 5/16'' \times 55\text{mm}$		8 PCS
B	LOCK WASHER/ RONDELLE DE BLOCAGE/ ARANDELA DE BLOQUEO $\varnothing 5/16'' \times 1,8\text{mm}$		8 PCS
C	FLAT WASHER/ RONDELLE PLATE/ ARANDELA PLANA $\varnothing 5/16''$		8 PCS
D	WRENCH/ CLÉ/LLAVE INGLESA		1 PC
E	LEVELER/ NIVELEUR/ NIVELADOR		2 PCS

LIST OF PARTS AND HARDWARE / LISTE DES PIÈCES ET DU MATÉRIEL/ LISTA DE PIEZAS Y HARDWARE			
NO#/ NOMBRE/ NÚMERO	DESCRIPTION/ DESCRIPTION/ DESCRIPCIÓN		QUANTITY/ QUANTITÉ/ CANTIDAD
1	CABINET BODY/ CORPS DE CABINET/CUERPO DEL GABINETE		1 PC
2	FRONT LEG/ JAMBE AVANT/ PIERNA FRONTA		2 PCS
3	BACK LEG/ JAMBE ARRIÈ/ PIERNA TRASERA		2 PCS
4	FURNITURE TIPPING RESTRAINT/ SYSTEME ANTIBASCULEMENT/ CONTROL PARA EVITAR VULCOS		1 SET

NOTE:
ASSEMBLE UNIT ON A SOFT SURFACE.
ASSEMBLEZ L'UNITÉ SUR UNE SURFACE MOLLE.
ENSAMBLE LA UNIDAD EN UNA SUPERFICIE PLANA Y SUAVE.

DO NOT TIGHTEN BOLTS UNTIL ALL PARTS AND HARDWARE OF THE UNIT ARE ASSEMBLED.
NE SERREZ PAS LES BOULONS JUSQU'À CE QUE L'UNITÉ SOIT COMPLÈMENT ASSEMBLÉE.
NO APRIETE LOS TORNILLOS HASTA QUE LA UNIDAD ESTE COMPLETAMENTE ENSAMBLADA.

ASSEMBLY INSTRUCTIONS INSTRUCTIONS DE MONTAGE INSTRUCCIONES DE MONTAJE

DRAWER CHEST

STEP/ ÉTAPE/ PASO 1

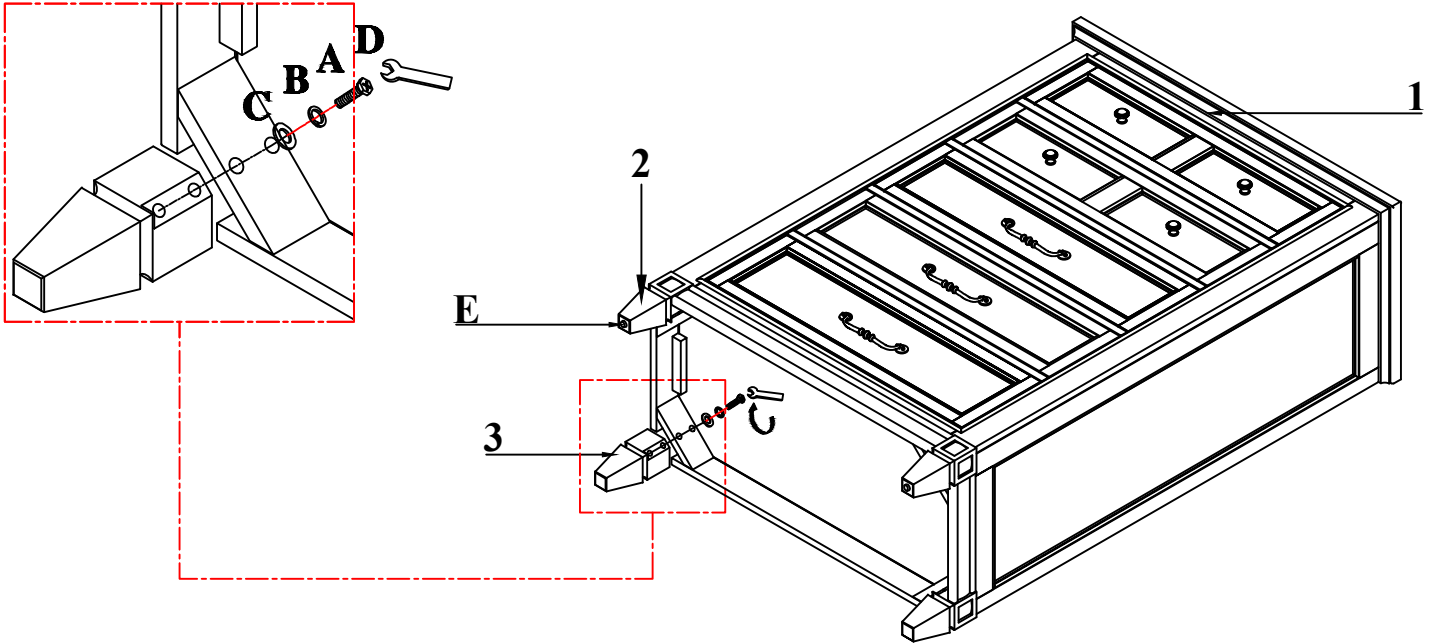

STEP/ ÉTAPE/ PASO 2

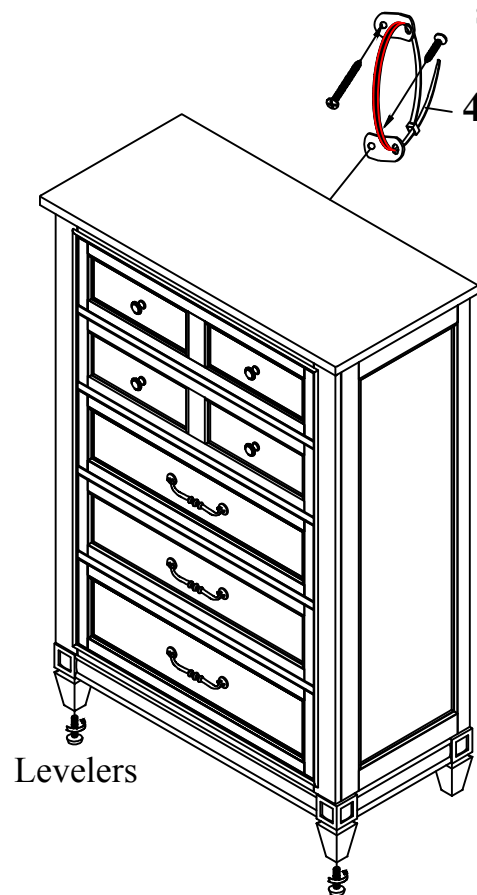

ASSEMBLY INSTRUCTIONS INSTRUCTIONS DE MONTAGE INSTRUCCIONES DE MONTAJE





DOOR CHEST





CAUTION: PLEASE READ ALL INSTRUCTIONS BEFORE STARTING THE ASSEMBLY OF THIS PRODUCT. THESE PIECES ARE HEAVY. IN ORDER TO PREVENT PERSONAL INJURY AND ENSURE THAT THIS PRODUCT IS NOT DAMAGED DURING THE ASSEMBLY PROCESS, IT IS STRONGLY RECOMMENDED TO ENLIST THE ASSISTANCE OF ONE OR MORE PERSONS. IN CASE OF EXCESS STAIN, WIPE THE BOTTOM OF THE UNIT BEFORE PLACING ON ANY SURFACE.

ATTENTION: VEUILLEZ LIRE TOUTES LES INSTRUCTIONS AVANT DE COMMENCER L'ASSEMBLAGE DE CE PRODUIT. LES PIÈCES SONT LOURDES. POUR ÉVITER TOUTE BLESSURE ET POUR VOUS ASSURER QUE LE PRODUIT N'EST PAS ENDOMMAGÉ PENDANT L'ASSEMBLAGE, NOUS VOUS RECOMMANDONS DE FAIRE APPEL À UNE OU PLUSIEURS AUTRES PERSONNES. EN CAS DE TACHE EXCESSIVE, ESSUYEZ LE FOND DE L'UNITÉ AVANT LE PLACEMENT SUR N'IMPORTE QUELLE SURFACE.

CUIDADO: FAVOR DE LEER TODAS LAS INSTRUCCIONES ANTES DE ENSAMBLAR SU PRODUCTO, ESTAS. PIEZAS SON PESADAS. PARA PREVENIR HERIDAS PERSONALES Y ASEGURAR QUE SU PRODUCTO NO SEA DANADO MIENTRAS ES ENSAMBLADO. SE RECOMIENDA LA ASISTENCIA DE UNA O MAS PERSONAS.

WARNING: PROTECTIVE GLIDE IS PLACED UNDER EACH LEG OF THE FURNITURE TO RESIST SCRATCHES ON FLOOR SURFACE. SOME FLOOR SURFACES CAN BE EXTRA SENSITIVE TO SCRATCHES AND MARKINGS, IF YOU ARE NOT SURE CONSULT WITH YOUR DEALER. AVERTISSEMENT. LES PIEDS DES MEUBLES SONT MUNIS DE PATINS DESTINÉS À PROTÉGER LE PLANCHER. CERTAINS REVÊTEMENTS DE SOL PEUVENT ÊTRE TRÈS FRAGILES. EN CAS DE DOUTE. CONSULTER LE MARCHAND.

LIST OF PARTS AND HARDWARE / LISTE DES PIÈCES ET DU MATÉRIEL/ LISTA DE PIEZAS Y HARDWARE			
NO#/ NOMBRE/ NÚMERO	DESCRIPTION/ DESCRIPTION/ DESCRIPCIÓN		QUANTITY/ QUANTITÉ/ CANTIDAD
A	BOLT/ BOULON/ TORNILLO $\varnothing 5/16'' \times 55\text{mm}$		8 PCS
B	LOCK WASHER/ RONDELLE DE BLOCAGE/ ARANDELA DE BLOQUEO $\varnothing 5/16'' \times 1,8\text{mm}$		8 PCS
C	FLAT WASHER/ RONDELLE PLATE/ ARANDELA PLANA $\varnothing 5/16''$		8 PCS
D	WRENCH/ CLÉ/LLAVE INGLESA		1 PC
E	LEVELER/ NIVELEUR/ NIVELADOR		3 PCS

LIST OF PARTS AND HARDWARE / LISTE DES PIÈCES ET DU MATÉRIEL/ LISTA DE PIEZAS Y HARDWARE			
NO#/ NOMBRE/ NÚMERO	DESCRIPTION/ DESCRIPTION/ DESCRIPCIÓN		QUANTITY/ QUANTITÉ/ CANTIDAD
1	CABINET BODY/ CORPS DE CABINET/CUERPO DEL GABINETE		1 PC
2	ADJUSTABLE SHELF/ TABLETTE AJUSTABLE/ ESTANTE AJUSTABLE		2 PCS
3	FRONT LEG/ JAMBE AVANT/ PIERNA FRONTA		2 PCS
4	BACK LEG/ JAMBE ARRIÈ/ PIERNA TRASERA		2 PCS
5	SUPPORT LEG/ JAMBE D'APPUI/ PIERNA DE APOYO		1 PC
6	FURNITURE TIPPING RESTRAINT/ SYSTEME ANTIBASCULEMENT/ CONTROL PARA EVITAR VULCOS		1 SET

NOTE:
ASSEMBLE UNIT ON A SOFT SURFACE.
ASSEMBLEZ L'UNITÉ SUR UNE SURFACE MOLLE.
ENSAMBLE LA UNIDAD EN UNA SUPERFICIE PLANA Y SUAVE.

DO NOT TIGHTEN BOLTS UNTIL ALL PARTS AND HARDWARE OF THE UNIT ARE ASSEMBLED.
NE SERREZ PAS LES BOULONS JUSQU'À CE QUE L'UNITÉ SOIT COMPLÈMENT ASSEMBLÉE.
NO APRIETE LOS TORNILLOS HASTA QUE LA UNIDAD ESTE COMPLETAMENTE ENSAMBLADA.

ASSEMBLY INSTRUCTIONS INSTRUCTIONS DE MONTAGE INSTRUCCIONES DE MONTAJE

DOOR CHEST

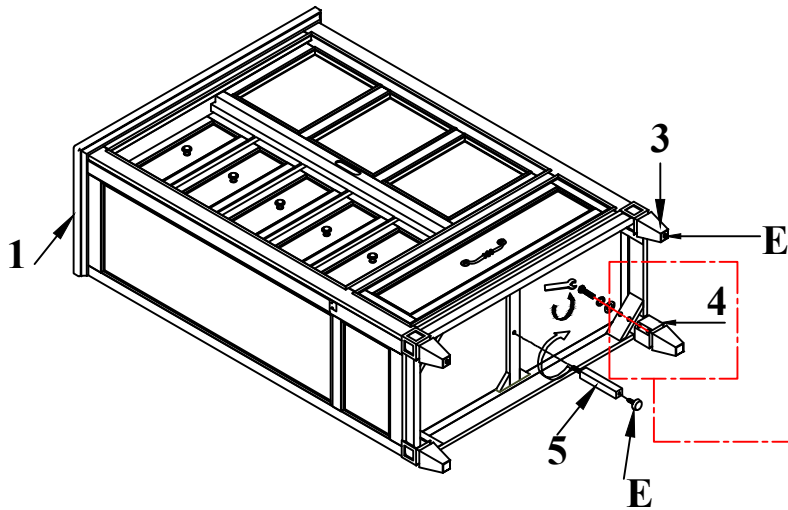

STEP/ ÉTAPE/ PASO 1

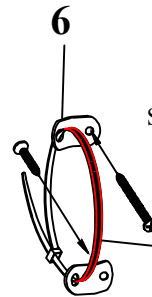
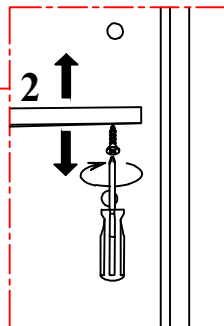
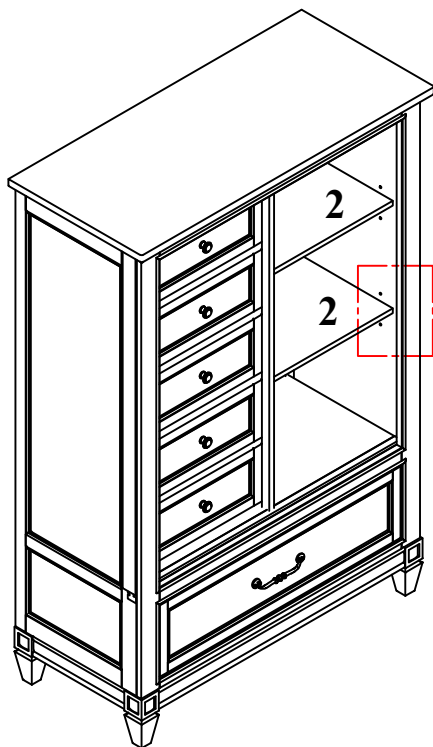
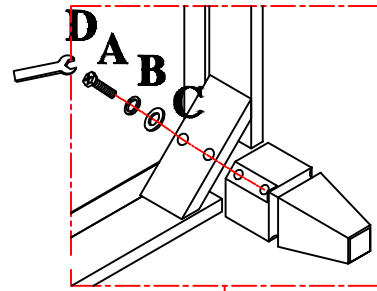

STEP/ ÉTAPE/ PASO 2



Levelers

ASSEMBLY INSTRUCTIONS INSTRUCTIONS DE MONTAGE INSTRUCCIONES DE MONTAJE





DRAWER DRESSER





CAUTION: PLEASE READ ALL INSTRUCTIONS BEFORE STARTING THE ASSEMBLY OF THIS PRODUCT. THESE PIECES ARE HEAVY. IN ORDER TO PREVENT PERSONAL INJURY AND ENSURE THAT THIS PRODUCT IS NOT DAMAGED DURING THE ASSEMBLY PROCESS, IT IS STRONGLY RECOMMENDED TO ENLIST THE ASSISTANCE OF ONE OR MORE PERSONS. IN CASE OF EXCESS STAIN, WIPE THE BOTTOM OF THE UNIT BEFORE PLACING ON ANY SURFACE.

ATTENTION: VEUILLEZ LIRE TOUTES LES INSTRUCTIONS AVANT DE COMMENCER L'ASSEMBLAGE DE CE PRODUIT. LES PIECES SONT LOURDES. POUR EVITER TOUTE BLESSURE ET POUR VOUS ASSURER QUE LE PRODUIT N'EST PAS ENDOMMAGE' PENDANT L'ASSEMBLAGE, NOUS VOUS RECOMMANDONS DE FAIRE APPEL A UNE OU PLUSIEURS AUTRES PERSONNES. EN CAS DE TACHE EXCESSIVE, ESSUYEZ LE FOND DE L'UNITE' AVANT LE PLACEMENT SUR N'IMPORTE QUELLE SURFACE.

CUIDADO: FAVOR DE LEER TODAS LAS INSTRUCCIONES ANTES DE ENSAMBLAR SU PRODUCTO, ESTAS. PIEZAS SON PESADAS. PARA PREVENIR HERIDAS PERSONALES Y ASEGURAR QUE SU PRODUCTO NO SEA DAN ADO MIENTRAS ES ENSAMBLADO. SE RECOMIENDA LA ASISTENCIA DE UNA O MAUS PERSONAS.

WARNING: PROTECTIVE GLIDE IS PLACED UNDER EACH LEG OF THE FURNITURE TO RESIST SCRATCHES ON FLOOR SURFACE. SOME FLOOR SURFACES CAN BE EXTRA SENSITIVE TO SCRATCHES AND MARKINGS, IF YOU ARE NOT SURE CONSULT WITH YOUR DEALER. AVERTISSEMENT. LES PIEDS DES MEUBLES SONT MUNIS DE PATINS DESTINES A PROTEGER LE PLANCHER. CERTAINS REVETEMENTS DE SOL PEUVENT ETRE TRES FRAGILES. EN CAS DE DOUTE. CONSULTER LE MARCHAND.

LIST OF PARTS AND HARDWARE / LISTE DES PIÈCES ET DU MATÉRIEL/ LISTA DE PIEZAS Y HARDWARE			
NO#/ NOMBRE/ NÚMERO	DESCRIPTION/ DESCRIPTION/ DESCRIPCIÓN		QUANTITY/ QUANTITÉ/ CANTIDAD
A	BOLT/ BOULON/ TORNILLO $\varnothing 5/16$ "*55mm		8 PCS
B	LOCK WASHER/ RONDELLE DE BLOCAGE/ ARANDELA DE BLOQUEO $\varnothing 5/16$ "*1,8mm		8 PCS
C	FLAT WASHER/ RONDELLE PLATE/ ARANDELA PLANA $\varnothing 5/16$ "		8 PCS
D	WRENCH/ CLÉ/LLAVE INGLESA		1 PC
E	LEVELER/ NIVELEUR/ NIVELADOR		3 PCS

LIST OF PARTS AND HARDWARE / LISTE DES PIÈCES ET DU MATÉRIEL/ LISTA DE PIEZAS Y HARDWARE			
NO#/ NOMBRE/ NÚMERO	DESCRIPTION/ DESCRIPTION/ DESCRIPCIÓN		QUANTITY/ QUANTITÉ/ CANTIDAD
1	CABINET BODY/ CORPS DE CABINET/CUERPO DEL GABINETE		1 PC
2	FRONT LEG/ JAMBE AVANT/PIERNA FRONTA		2 PCS
3	BACK LEG/ JAMBE ARRIÈ/ PIERNA TRASERA		2 PCS
4	SUPPORT LEG/ JAMBE D'APPUI/ PIERNA DE APOYO		1 PC
5	FURNITURE TIPPING RESTRAINT/ SYSTEME ANTIBASCULEMENT/ CONTROL PARA EVITAR VULCOS		1 SET

NOTE:
ASSEMBLE UNIT ON A SOFT SURFACE.
ASSEMBLEZ L'UNITÉ SUR UNE SURFACE MOLLE.
ENSAMBLE LA UNIDAD EN UNA SUPERFICIE PLANA Y SUAVE.

DO NOT TIGHTEN BOLTS UNTIL ALL PARTS AND HARDWARE OF THE UNIT ARE ASSEMBLED.
NE SERREZ PAS LES BOULONS JUSQU'À CE QUE L'UNITÉ SOIT COMPLÈMENT ASSEMBLÉE.
NO APRIETE LOS TORNILLOS HASTA QUE LA UNIDAD ESTE COMPLETAMENTE ENSAMBLADA.

ASSEMBLY INSTRUCTIONS INSTRUCTIONS DE MONTAGE INSTRUCCIONES DE MONTAJE

DRAWER DRESSER

STEP/ ÉTAPE/ PASO 1

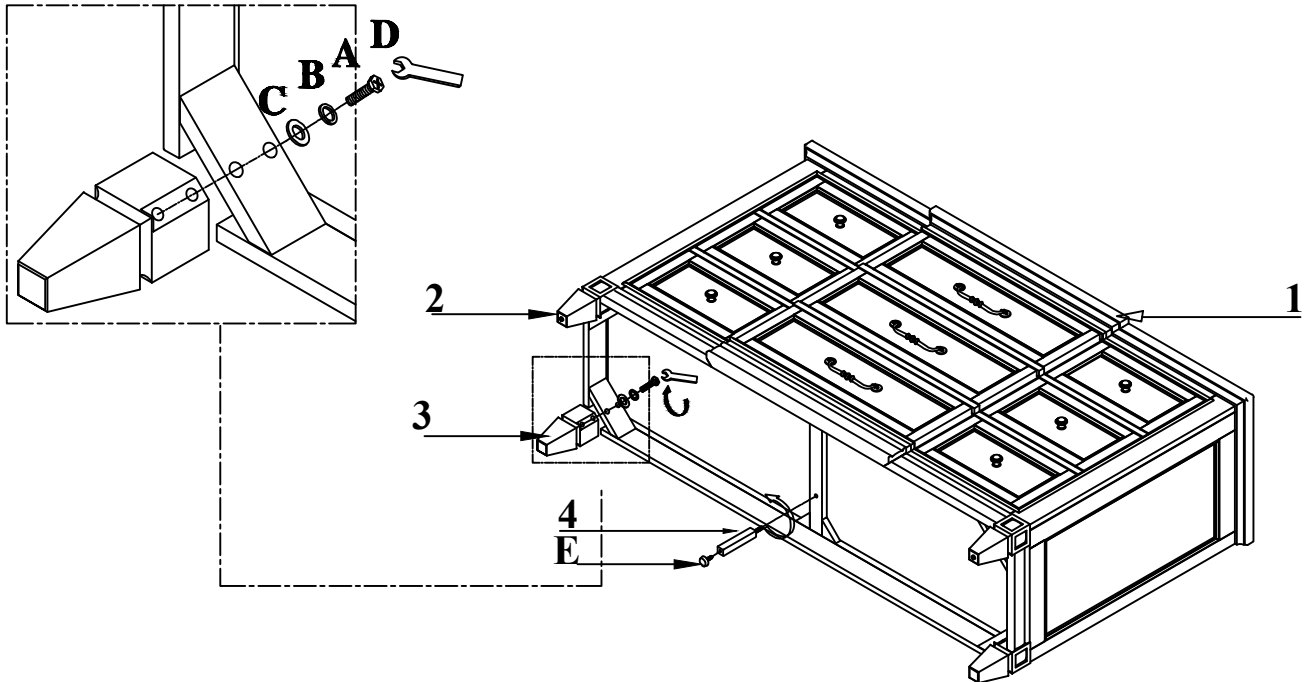

STEP/ ÉTAPE/ PASO 2

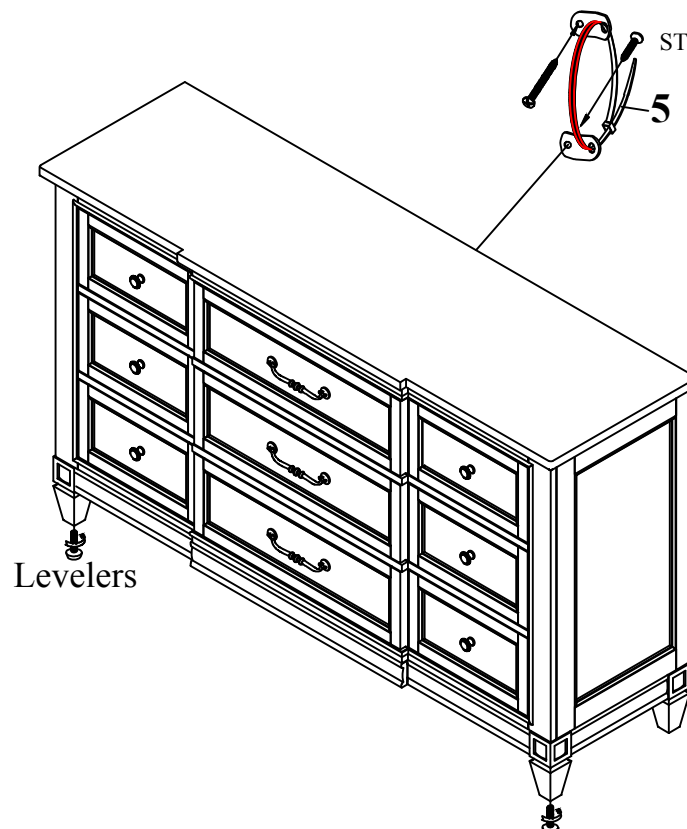

ASSEMBLY INSTRUCTIONS

INSTRUCTIONS DE MONTAGE

INSTRUCCIONES DE MONTAJE





MIRROR



CAUTION: PLEASE READ ALL INSTRUCTIONS BEFORE STARTING THE ASSEMBLY OF THIS PRODUCT. THESE PIECES ARE HEAVY. IN ORDER TO PREVENT PERSONAL INJURY AND ENSURE THAT THIS PRODUCT IS NOT DAMAGED DURING THE ASSEMBLY PROCESS, IT IS STRONGLY RECOMMENDED TO ENLIST THE ASSISTANCE OF ONE OR MORE PERSONS. IN CASE OF EXCESS STAIN, WIPE THE BOTTOM OF THE UNIT BEFORE PLACING ON ANY SURFACE.

ATTENTION: VEUILLEZ LIRE TOUTES LES INSTRUCTIONS AVANT DE COMMENCER L'ASSEMBLAGE DE CE PRODUIT. LES PIÈCES SONT LOURDES. POUR ÉVITER TOUTE BLESSURE ET POUR VOUS ASSURER QUE LE PRODUIT N'EST PAS ENDOMMAGÉ PENDANT L'ASSEMBLAGE, NOUS VOUS RECOMMANDONS DE FAIRE APPEL À UNE OU PLUSIEURS AUTRES PERSONNES. EN CAS DE TACHE EXCESSIVE, ESSUYEZ LE FOND DE L'UNITÉ AVANT LE PLACEMENT SUR N'IMPORTE QUELLE SURFACE.

CUIDADO: FAVOR DE LEER TODAS LAS INSTRUCCIONES ANTES DE ENSAMBLAR SU PRODUCTO, ESTAS PIEZAS SON PESADAS. PARA PREVENIR HERIDAS PERSONALES Y ASEGURAR QUE SU PRODUCTO NO SEA DAÑADO MIENTRAS ES ENSAMBLADO. SE RECOMIENDA LA ASISTENCIA DE UNA O MÁS PERSONAS.

WARNING: PROTECTIVE GLIDE IS PLACED UNDER EACH LEG OF THE FURNITURE TO RESIST SCRATCHES ON FLOOR SURFACE. SOME FLOOR SURFACES CAN BE EXTRA SENSITIVE TO SCRATCHES AND MARKINGS, IF YOU ARE NOT SURE CONSULT WITH YOUR DEALER. AVERTISSEMENT. LES PIEDS DES MEUBLES SONT MUNIS DE PATINS DESTINÉS À PROTÉGER LE PLANCHER. CERTAINS REVÊTEMENTS DE SOL PEUVENT ÊTRE TRÈS FRAGILES. EN CAS DE DOUTE, CONSULTEZ LE MARCHAND.

LIST OF PARTS AND HARDWARE/ LISTE DES PIÈCES ET DU MATÉRIEL/ LISTA DE PIEZAS Y HARDWARE			
NO#/ NOMBRE/ NÚMERO	DESCRIPTION/ DESCRIPTION/ DESCRIPCIÓN		QUANTITY/ QUANTITÉ/ CANTIDAD
A	BOLT/ BOULON/ TORNILLO Φ 1/4" * 32 mm		8 PCS
B	LOCK WASHER/ RONDELLE DE BLOCAGE/ ARANDELA DE BLOQUEO Φ 1/4" * 1,5 mm		8 PCS
C	FLAT WASHER/ RONDELLE PLATE/ ARANDELA PLANA Φ 1/4"		8 PCS
D	WRENCH/ CLÉ/ LLAVE INGLESA		1 PC

LIST OF PARTS AND HARDWARE/ LISTE DES PIÈCES ET DU MATÉRIEL/ LISTA DE PIEZAS Y HARDWARE			
NO#/ NOMBRE/ NÚMERO	DESCRIPTION/ DESCRIPTION/ DESCRIPCIÓN		QUANTITY/ QUANTITÉ/ CANTIDAD
1	DRESSER/LA COMMODE/ VESTIDOR		1 PC
2	MIRROR/ MIROIR/ ESPEJO		1 PC
3	MIRROR SUPPORT BAR/ BARRE DE SUPPORT DE MIROIR/ BARRA DE SOPORTE DE ESPEJO		2 PCS

NOTE:
ASSEMBLE UNIT ON A SOFT SURFACE.
ASSEMBLEZ L'UNITÉ SUR UNE SURFACE MOLLE.
ENSAMBLE LA UNIDAD EN UNA SUPERFICIE PLANA Y SUAVE.

DO NOT TIGHTEN BOLTS UNTIL THE UNIT IS COMPLETELY ASSEMBLED.
NE SERREZ PAS LES BOULONS JUSQU'À CE QUE L'UNITÉ SOIT COMPLÈTEMENT ASSEMBLÉE.
NO APRIETE LOS TORNILLOS HASTA QUE LA UNIDAD ESTE COMPLETAMENTE ENSAMBLADA.

ASSEMBLY INSTRUCTIONS
INSTRUCTIONS DE MONTAGE
INSTRUCCIONES DE MONTAJE
MIRROR

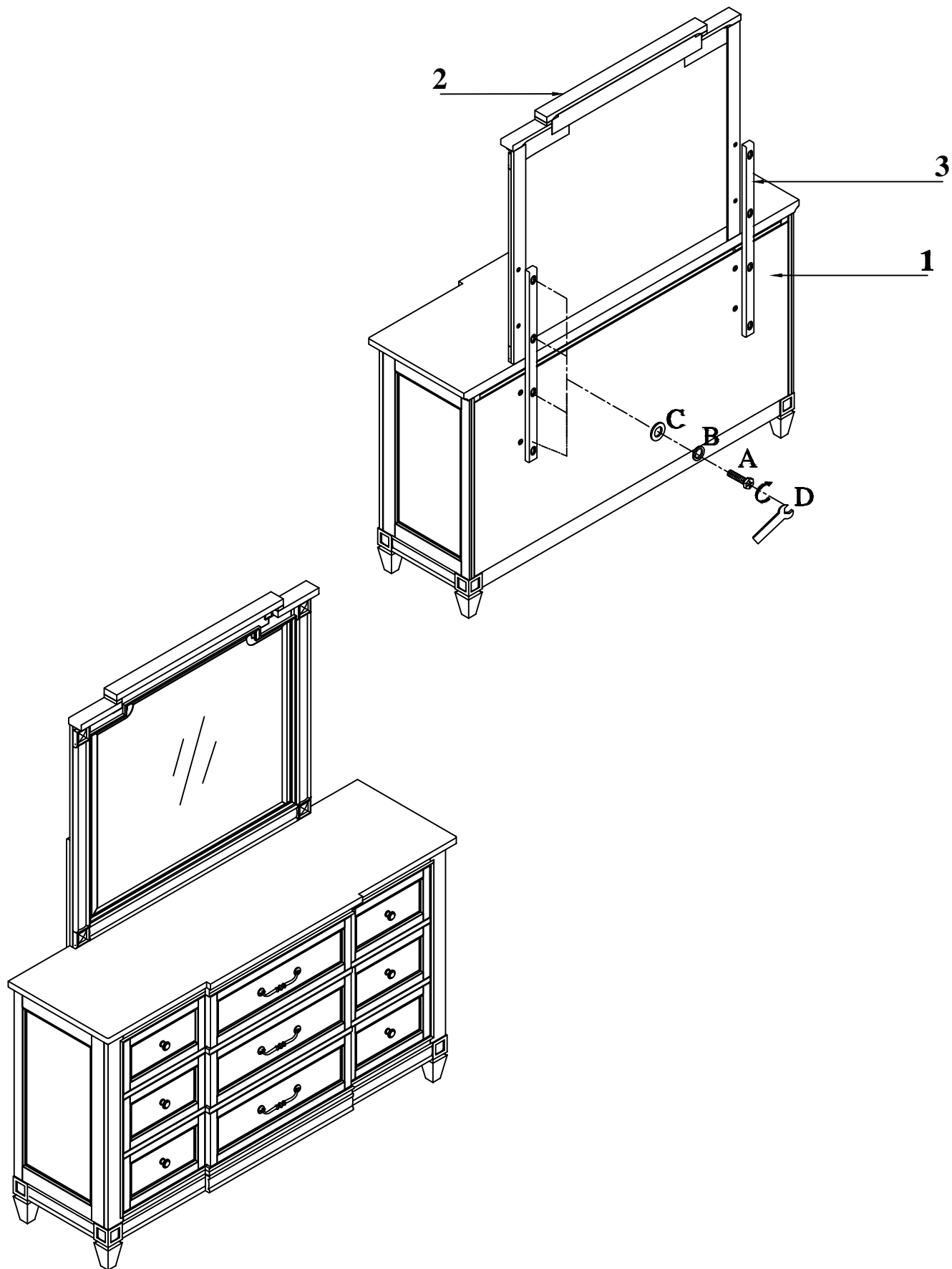

ASSEMBLY INSTRUCTIONS

INSTRUCTIONS DE MONTAGE

INSTRUCCIONES DE MONTAJE

QUEEN PANEL BED
QUEEN UPHOLSTERY BED
QUEEN PANEL BED W/ STORAGE FOOTBOARD
QUEEN UPHOLSTERY BED W/STORAGE FOOTBOARD

CAUTION: PLEASE READ ALL INSTRUCTIONS BEFORE STARTING THE ASSEMBLY OF THIS PRODUCT. THESE PIECES ARE HEAVY. IN ORDER TO PREVENT PERSONAL INJURY AND ENSURE THAT THIS PRODUCT IS NOT DAMAGED DURING THE ASSEMBLY PROCESS, IT IS STRONGLY RECOMMENDED TO ENLIST THE ASSISTANCE OF ONE OR MORE PERSONS. IN CASE OF EXCESS STAIN, WIPE THE BOTTOM OF THE UNIT BEFORE PLACING ON ANY SURFACE.

ATTENTION: VEUILLEZ LIRE TOUTES LES INSTRUCTIONS AVANT DE COMMENCER L'ASSEMBLAGE DE CE PRODUIT. LES PIECES SONT LOURDES. POUR EVITER TOUTE BLESSURE ET POUR VOUS. ASSURER QUE LE PRODUIT N'EST PAS ENDOMMAGE' PENDANT L'ASSEMBLAGE, NOUS VOUS RECOMMANDONS DE FAIRE APPEL A UNE OU PLUSIEURS AUTRES PERSONNES. EN CAS DE TACHE EXCESSIVE, ESSUYEZ LE FOND DE L'UNITE' AVANT LE PLACEMENT SUR N'IMPORTE QUELLE SURFACE.

CUIDADO: FAVOR DE LEER TODAS LAS INSTRUCCIONES ANTES DE ENSAMBLAR SU PRODUCTO, ESTAS. PIEZAS SON PESADAS. PARA PREVENIR HERIDAS PERSONALES Y ASEGURAR QUE SU PRODUCTO NO SEA DAN ADO MIENTRAS ES ENSAMBLADO. SE RECOMIENDA LA ASISTENCIA DE UNA O MAUS PERSONAS.

WARNING: PROTECTIVE GLIDE IS PLACED UNDER EACH LEG OF THE FURNITURE TO RESIST SCRATCHES ON FLOOR SURFACE. SOME FLOOR SURFACES CAN BE EXTRA SENSITIVE TO SCRATCHES AND MARKINGS, IF YOU ARE NOT SURE CONSULT WITH YOUR DEALER.
AVERTISSEMENT. LES PIEDS DES MEUBLES SONT MUNIS DE PATINS DESTINES A PROTEGER LE PLANCHER. CERTAINS REVETEMENTS DE SOL PEUVENT ETRE TRES FRAGILES. EN CAS DE DOUTE. CONSULTER LE MARCHAND.

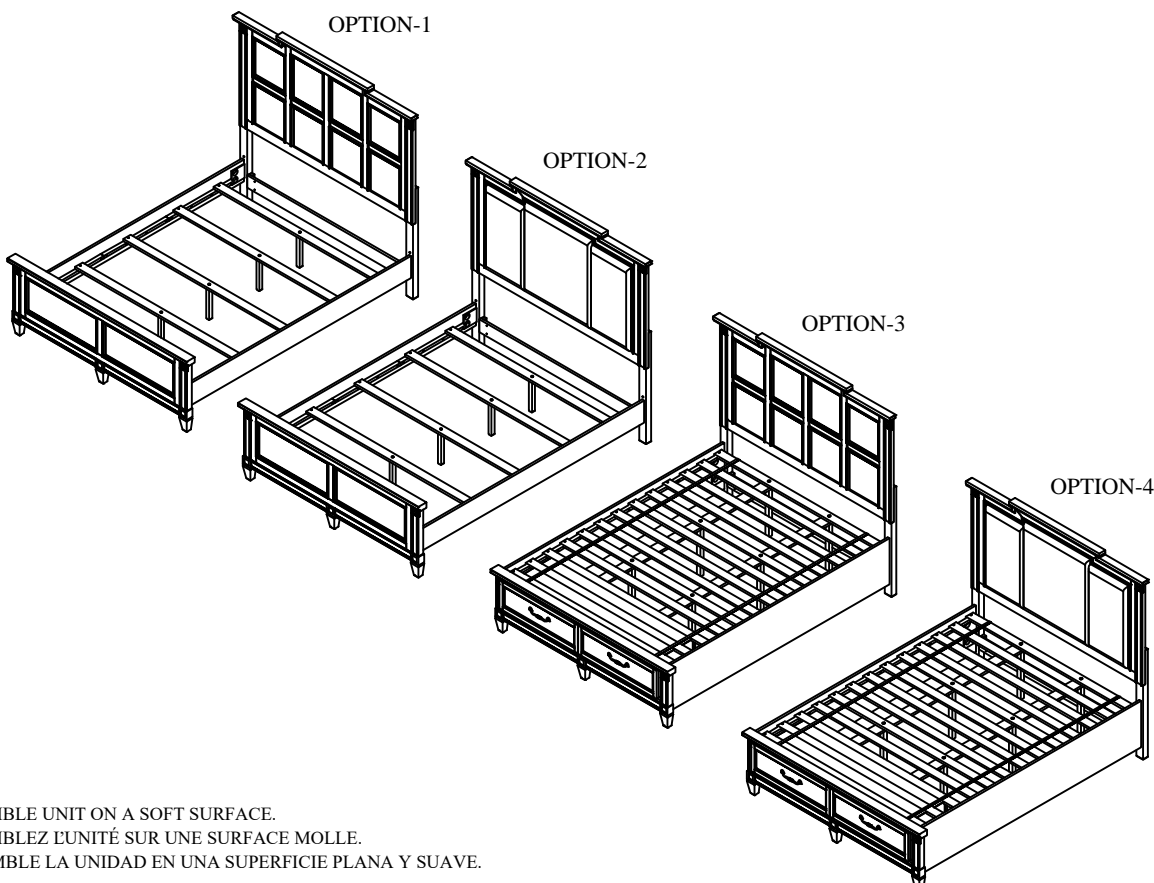









NOTE:
ASSEMBLE UNIT ON A SOFT SURFACE.
ASSEMBLEZ L'UNITÉ SUR UNE SURFACE MOLLE.
ENSAMBLE LA UNIDAD EN UNA SUPERFICIE PLANA Y SUAVE.

DO NOT TIGHTEN BOLTS UNTIL ALL PARTS AND HARDWARE OF THE UNIT ARE ASSEMBLED.
NE SERREZ PAS LES BOULONS JUSQU'À CE QUE L'UNITÉ SOIT COMPLÈTEMENT ASSEMBLÉE.
NO APRIETE LOS TORNILLOS HASTA QUE LA UNIDAD ESTE COMPLETAMENTE ENSAMBLADA.









ASSEMBLY INSTRUCTIONS INSTRUCTIONS DE MONTAGE INSTRUCCIONES DE MONTAJE

QUEEN PANEL BED
QUEEN UPHOLSTERY BED
QUEEN PANEL BED W/ STORAGE FOOTBOARD
QUEEN UPHOLSTERY BED W/STORAGE FOOTBOARD

LIST OF PARTS AND HARDWARE/ LISTE DES PIÈCES ET DU MATÉRIEL/ LISTA DE PIEZAS Y HARDWARE

NO#/ NOMBRE/ NÚMERO	DESCRIPTION/ DESCRIPTION/ DESCRIPCIÓN		QUANTITY/ QUANTITÉ/ CANTIDAD
A	BOLT/ BOULON/ TORNILLO $\frac{5}{16}$ " DIAMETER x $4\frac{1}{2}$ " LENGTH		8 PCS
B	LOCK WASHER "C"/ RONDELLE DE BLOCAGE "C"/ ARANDELA DE BLOQUEO "C" $\frac{5}{16}$ " DIAMETER		8 PCS
C	NUT/ ÉCROU/ NUEZ $\frac{5}{16}$ " DIAMETER		8 PCS
D	WRENCH/ CLÉ/ LLAVE INGLESA $\frac{1}{2}$ "		1 PC
E	FLAT WASHER/ RONDELLE PLATE/ ARANDELA PLANA $\frac{5}{16}$ " DIAMETER x $\frac{3}{4}$ " x $\frac{1}{16}$ "		8 PCS
F	LOCK WASHER/ RONDELLE DE BLOCAGE/ ARANDELA DE BLOQUEO $\frac{5}{16}$ " DIAMETER x $\frac{1}{2}$ " x $\frac{1}{16}$ "		8 PCS
G	BOLT/ BOULON/ TORNILLO $\frac{5}{16}$ " DIAMETER x $1\frac{3}{4}$ " LENGTH		8 PCS
I	SCREW/ VIS/ TORNILLO (54F) M4 x $1\frac{1}{4}$ " LENGTH		8 PCS
H	SCREW/ VIS/ TORNILLO (55F) M4 x $1\frac{1}{4}$ " LENGTH		28 PCS

LIST OF PARTS AND HARDWARE/ LISTE DES PIÈCES ET DU MATÉRIEL/ LISTA DE PIEZAS Y HARDWARE

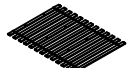
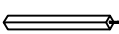
NO#/ NOMBRE/ NÚMERO	DESCRIPTION/ DESCRIPTION/ DESCRIPCIÓN		QUANTITY/ QUANTITÉ/ CANTIDAD
1	HEADBOARD PANEL/PANNEAU DE TÊTE DE LIT/PANEL DE CABECERO		1 PC
2	KD LEFT HEADBOARD LEG/JAMBE GAUCHE DE TÊTE DE LIT KD/ PATA IZQUIERDA KD PARA CABEZERA (L)		1 PC
3	KD RIGHT HEADBOARD LEG/JAMBE DROITE DE TÊTE DE LIT KD/ PATA DERECHA KD PARA CABEZERA (R)		1 PC
4	BOTTOM STRETCHER/ÉTIREUSE INFÉRIEURE/CAMILLA INFERIOR		1 PC
5	FOOTBOARD/ PIED DE LIT/ ESTRIBO		1 PC
6	SIDE RAIL / RAIL LATÉRAL / CARRIL LATERAL		2 PCS
7	SLAT/LAMELLE/LAMA (54F)		4 PCS
8	SLAT SUPPORT LEG/JAMBE DE SUPPORT À LATTES/ PATAS DE SOPORTE DE LAMAS (54F)		4 PCS
9	BOTTOM SLAT/LAME INFÉRIEURE/LLANTA INFERIOR (55F)		2 PCS
10	SLAT ROLL (INCLUDED 13 PCS)/ROULEAU DE FENTE/ ROLLO DE RANURA (55F)		1 SET
11	SLAT SUPPORT LEG/JAMBE DE SUPPORT À LATTES/ PATAS DE SOPORTE DE LAMAS (55F)		6 PCS

NOTE:
SPIRIT LEVELER NOT INCLUDED BUT NEEDED TO EVEN THE FLOOR.
SPIRIT LEVELER NON INCLUS MAIS NÉCESSAIRE MÊME LE SOL.
NIVELADOR DE ESPÍRITU NO INCLUIDO PERO ES NECESARIO PARA INCLUSO EL PISO.

ASSEMBLY INSTRUCTIONS

INSTRUCTIONS DE MONTAGE

INSTRUCCIONES DE MONTAJE

QUEEN PANEL BED

OPTION-1

Note:



Step/ tape/ Paso 2

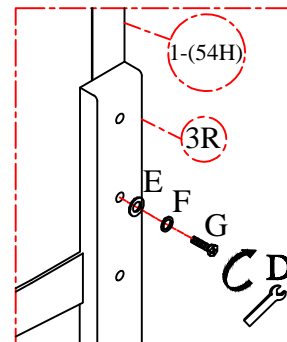

Step/ tape/ Paso 1

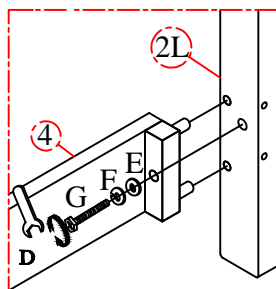

Step/ tape/ Paso 6

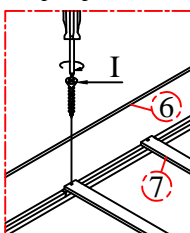

Step/ tape/ Paso 5

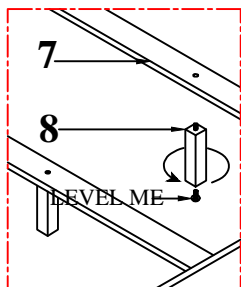

LEFT LEG

RIGHT LEG

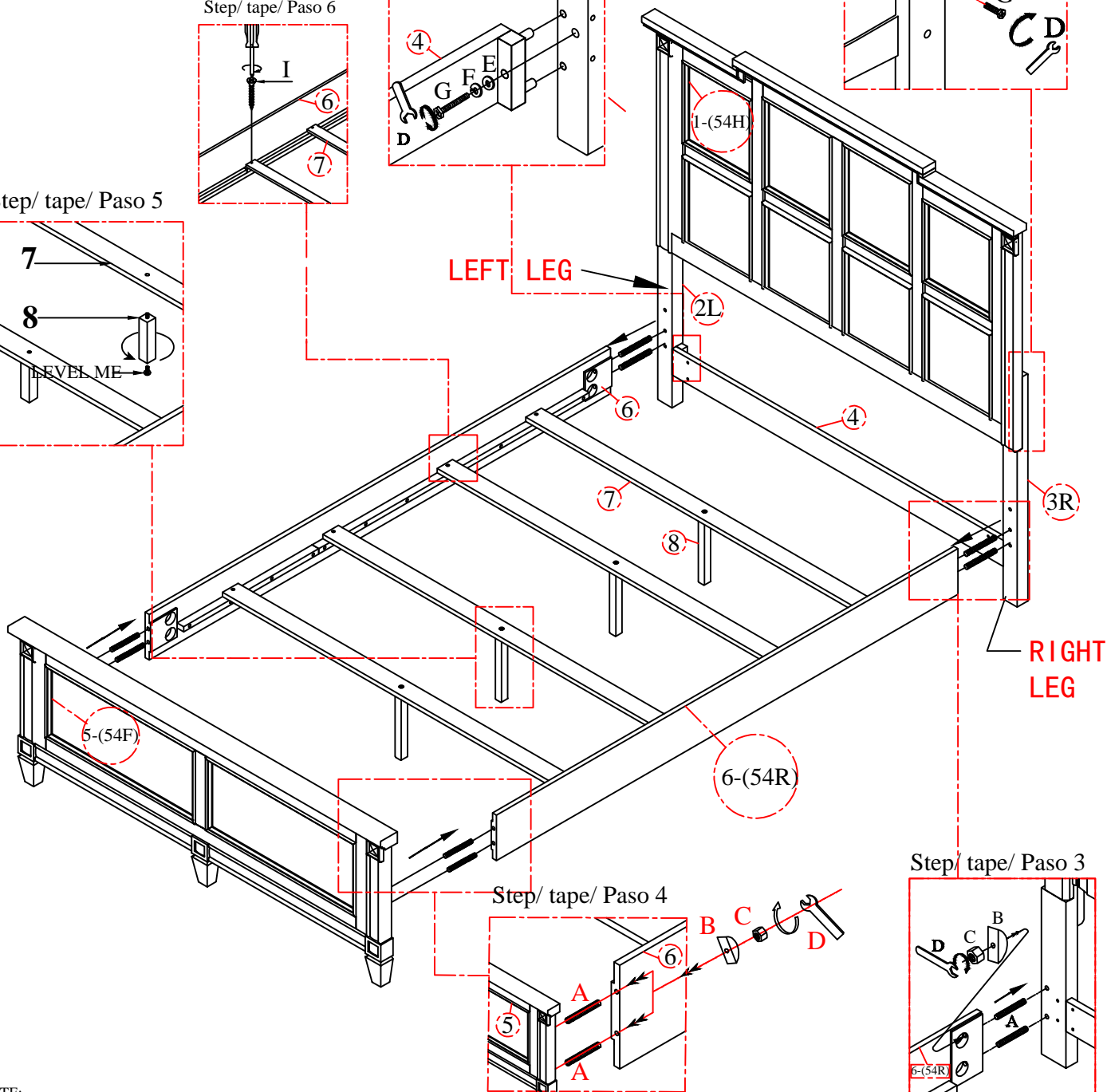

NOTE:
 SPIRIT LEVELER NOT INCLUDED BUT NEEDED TO EVEN THE FLOOR.
 SPIRIT LEVELER NON INCLUS MAIS NÉCESSAIRE MÊME LE SOL.
 NIVELADOR DE ESPÍRITU NO INCLUIDO PERO ES NECESARIO PARA INCLUSO EL PISO.

ASSEMBLY INSTRUCTIONS

INSTRUCTIONS DE MONTAGE

INSTRUCCIONES DE MONTAJE

QUEEN UPHOLSTERY BED

OPTION-2

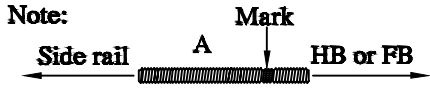

Step/tape/ Paso 2

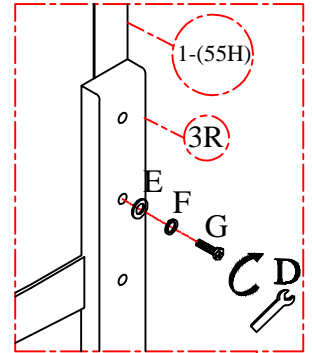

Step/ tape/ Paso 1

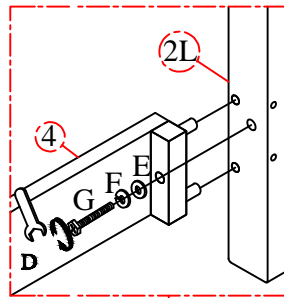

Step/ tape/ Paso 6

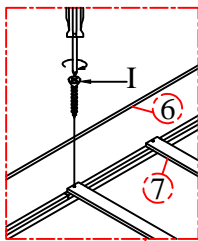

Step/ tape/ Paso 5

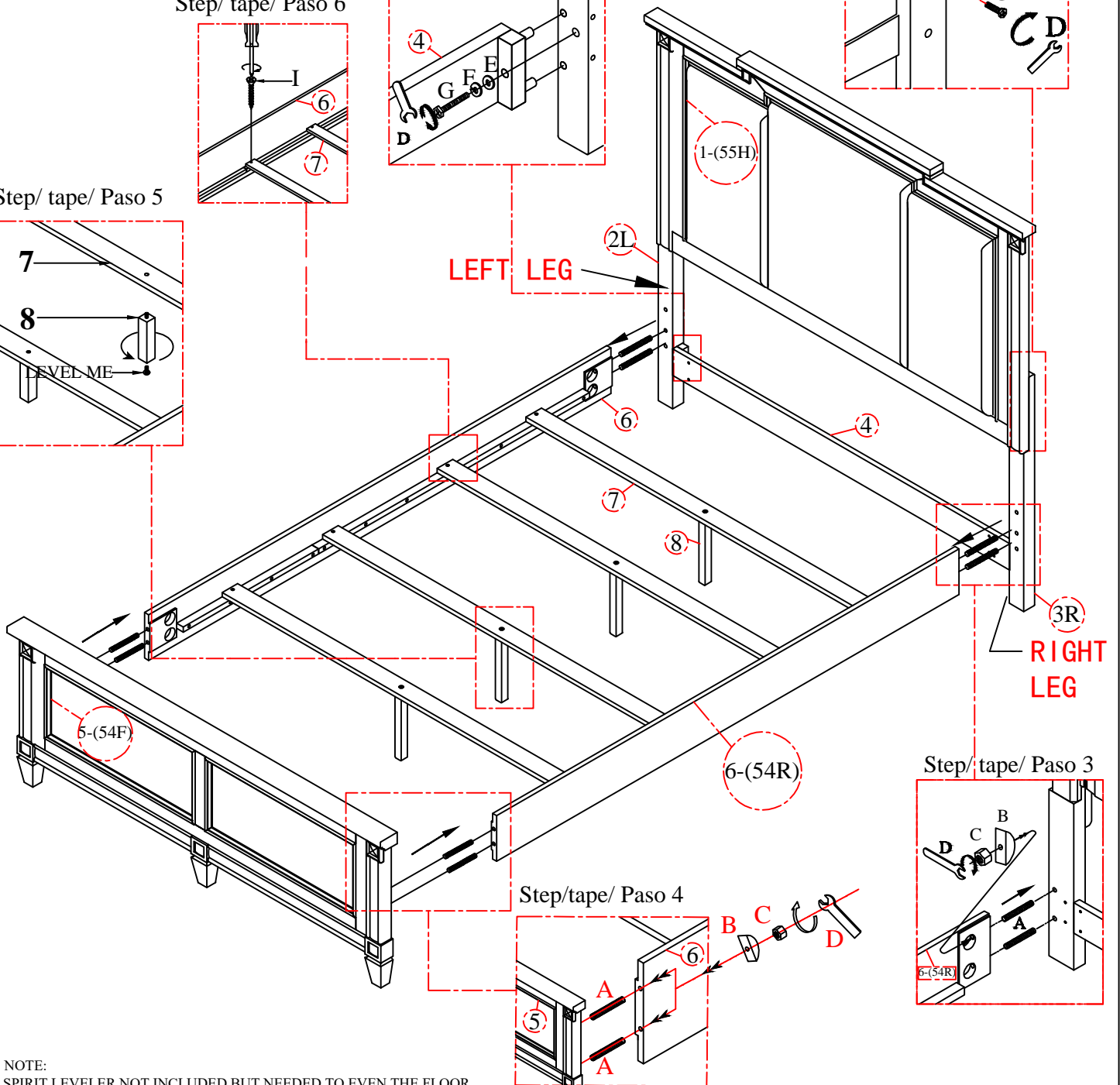
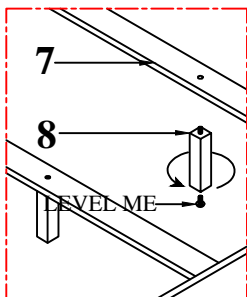

Step/tape/ Paso 3

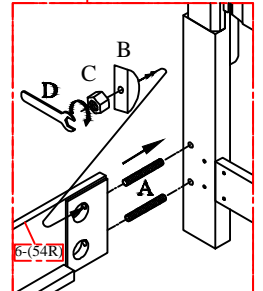

Step/tape/ Paso 4

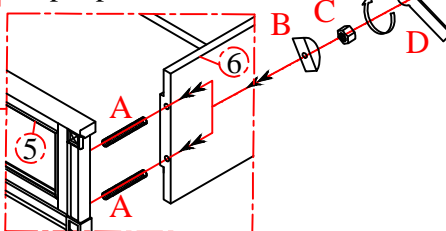

NOTE:
 SPIRIT LEVELER NOT INCLUDED BUT NEEDED TO EVEN THE FLOOR.
 SPIRIT LEVELER NON INCLUS MAIS NÉCESSAIRE MÊME LE SOL.
 NIVELADOR DE ESPÍRITU NO INCLUIDO PERO ES NECESARIO PARA INCLUSO EL PISO.

ASSEMBLY INSTRUCTIONS INSTRUCTIONS DE MONTAGE INSTRUCCIONES DE MONTAJE

QUEEN PANEL BED W/ STORAGE
FOOTBOARD

OPTION-3

Note:

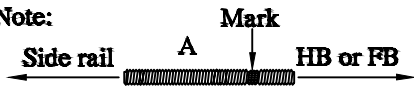

Step/ tape/ Paso 2

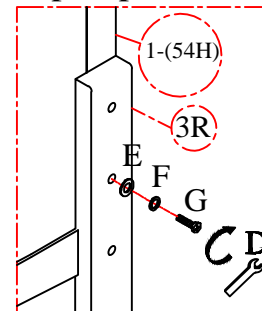

Step/tape/ Paso 1

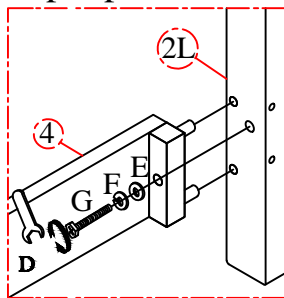

Step/ tape/ Paso 6

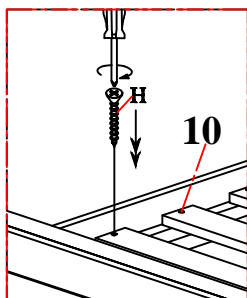

Step/ tape/ Paso 5

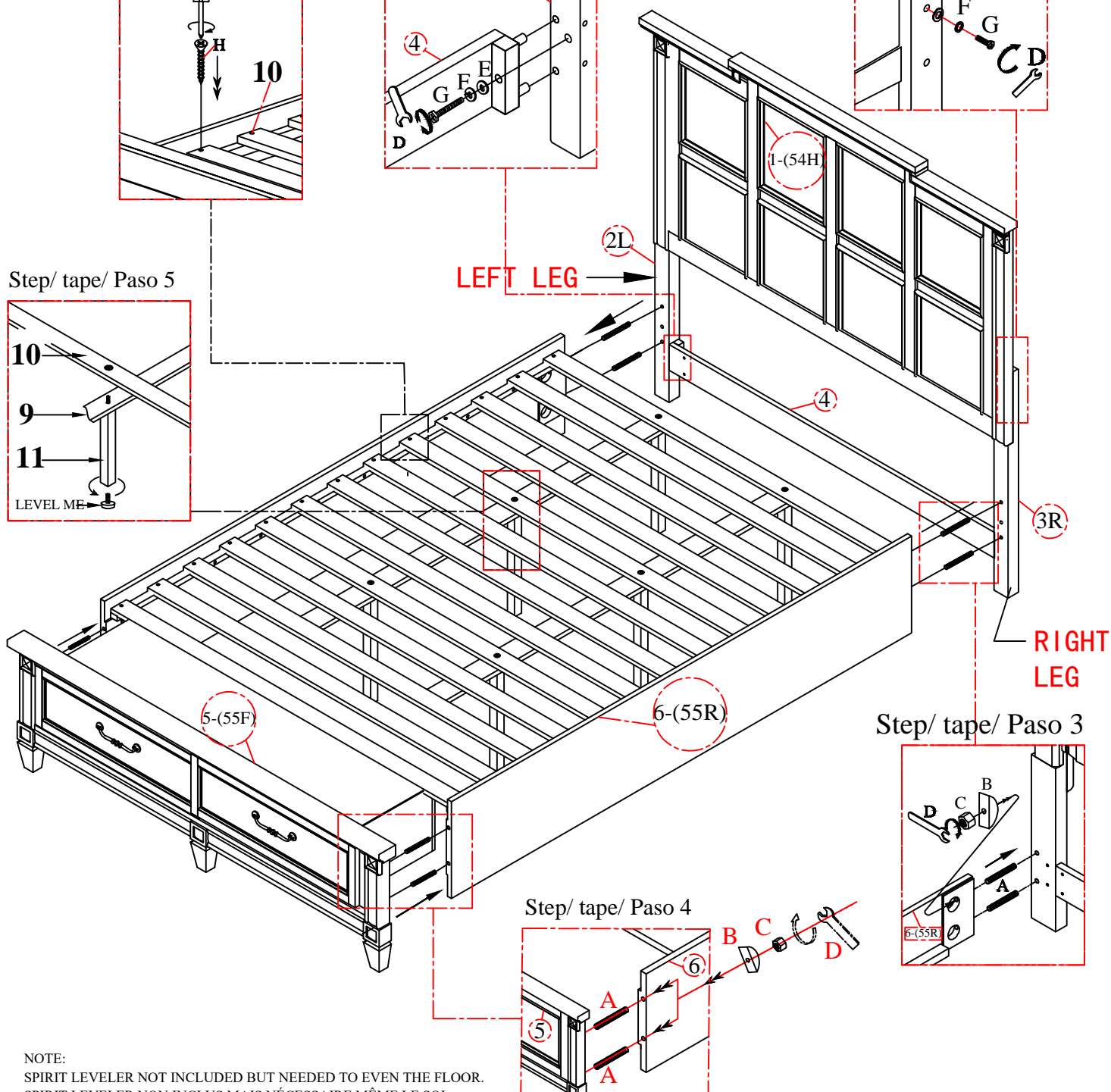
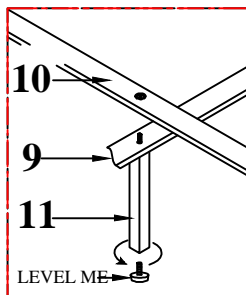

Step/ tape/ Paso 3

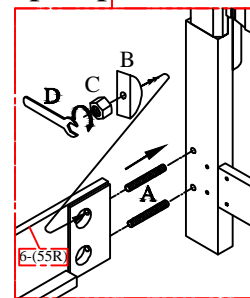

Step/ tape/ Paso 4

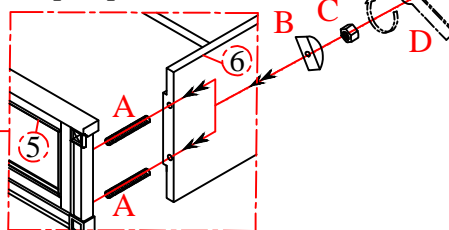

NOTE:
SPIRIT LEVELER NOT INCLUDED BUT NEEDED TO EVEN THE FLOOR.
SPIRIT LEVELER NON INCLUS MAIS NÉCESSAIRE MÊME LE SOL.
NIVELADOR DE ESPÍRITU NO INCLUIDO PERO ES NECESARIO PARA INCLUSO EL PISO.

ASSEMBLY INSTRUCTIONS

INSTRUCTIONS DE MONTAGE

INSTRUCCIONES DE MONTAJE

QUEEN UPHOLSTERY BED W/STORAGE
FOOTBOARD

OPTION-4

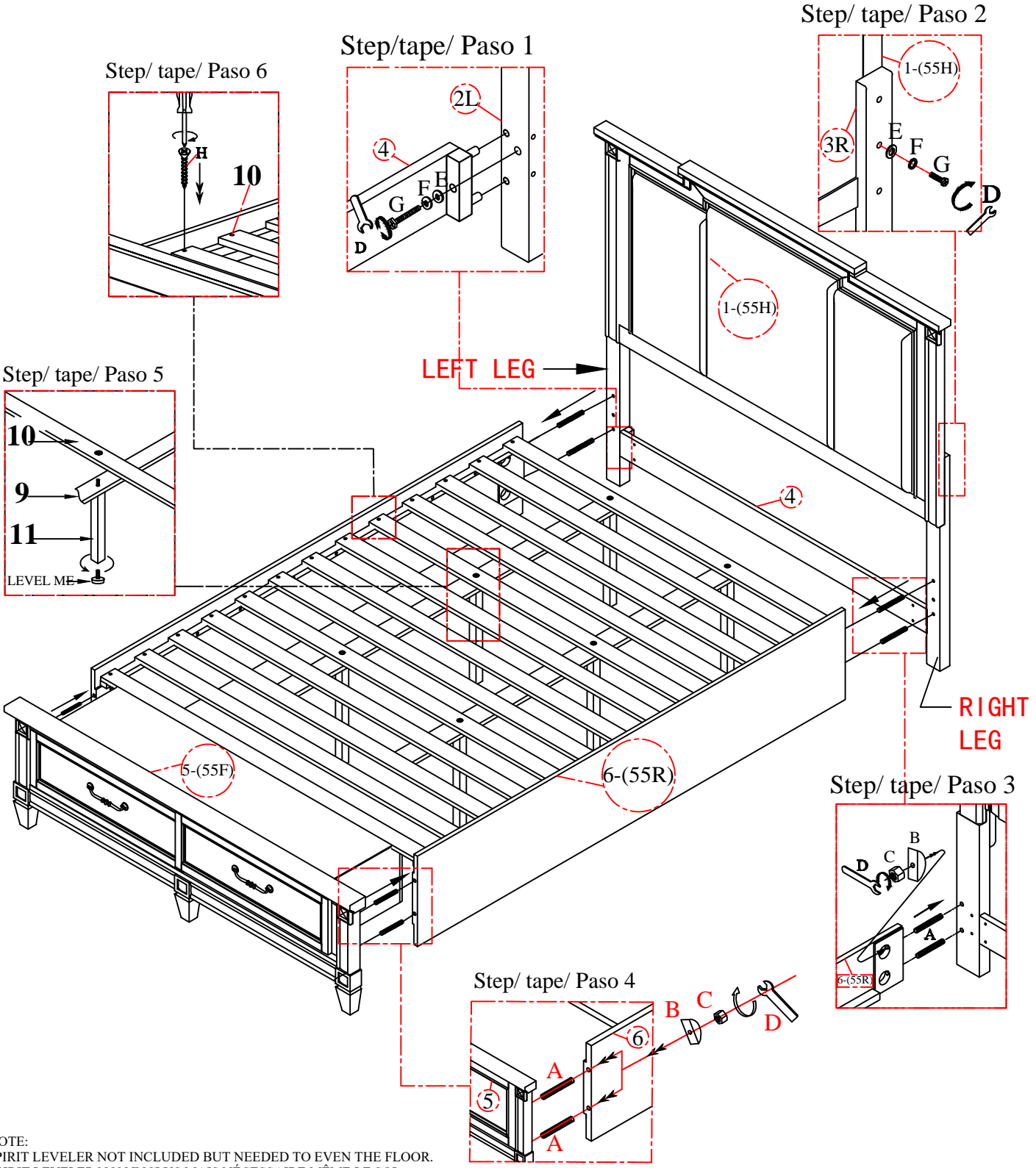
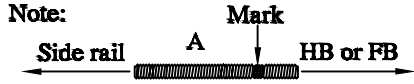

NOTE:
SPIRIT LEVELER NOT INCLUDED BUT NEEDED TO EVEN THE FLOOR.
SPIRIT LEVELER NON INCLUS MAIS NÉCESSAIRE MÊME LE SOL.
NIVELADOR DE ESPÍRITU NO INCLUIDO PERO ES NECESARIO PARA INCLUSO EL PISO.

ASSEMBLY INSTRUCTIONS INSTRUCTIONS DE MONTAGE INSTRUCCIONES DE MONTAJE

KING PANEL BED
KING UPHOLSTERY BED
KING PANEL BED W/STORAGE FOOTBOARD
KING UPHOLSTERY BED W/STORAGE FOOTBOARD

CAUTION: PLEASE READ ALL INSTRUCTIONS BEFORE STARTING THE ASSEMBLY OF THIS PRODUCT. THESE PIECES ARE HEAVY. IN ORDER TO PREVENT PERSONAL INJURY AND ENSURE THAT THIS PRODUCT IS NOT DAMAGED DURING THE ASSEMBLY PROCESS, IT IS STRONGLY RECOMMENDED TO ENLIST THE ASSISTANCE OF ONE OR MORE PERSONS. IN CASE OF EXCESS STAIN, WIPE THE BOTTOM OF THE UNIT BEFORE PLACING ON ANY SURFACE.

ATTENTION: VEUILLEZ LIRE TOUTES LES INSTRUCTIONS AVANT DE COMMENCER L'ASSEMBLAGE DE CE PRODUIT. LES PIECES SONT LOURDES. POUR EVITER TOUTE BLESSURE ET POUR VOUS. ASSURER QUE LE PRODUIT N'EST PAS ENDOMMAGE' PENDANT L'ASSEMBLAGE, NOUS VOUS RECOMMANDONS DE FAIRE APPEL A UNE OU PLUSIEURS AUTRES PERSONNES. EN CAS DE TACHE EXCESSIVE, ESSUYEZ LE FOND DE L'UNITE' AVANT LE PLACEMENT SUR N'IMPORTE QUELLE SURFACE.

CUIDADO: FAVOR DE LEER TODAS LAS INSTRUCCIONES ANTES DE ENSAMBLAR SU PRODUCTO, ESTAS. PIEZAS SON PESADAS. PARA PREVENIR HERIDAS PERSONALES Y ASEGURAR QUE SU PRODUCTO NO SEA DAN ADO MIENTRAS ES ENSAMBLADO. SE RECOMIENDA LA ASISTENCIA DE UNA O MAUS PERSONAS.

WARNING: PROTECTIVE GLIDE IS PLACED UNDER EACH LEG OF THE FURNITURE TO RESIST SCRATCHES ON FLOOR SURFACE. SOME FLOOR SURFACES CAN BE EXTRA SENSITIVE TO SCRATCHES AND MARKINGS, IF YOU ARE NOT SURE CONSULT WITH YOUR DEALER.
AVERTISSEMENT. LES PIEDS DES MEUBLES SONT MUNIS DE PATINS DESTINES A PROTEGER LE PLANCHER. CERTAINS REVETEMENTS DE SOL PEUVENT ETRE TRES FRAGILES. EN CAS DE DOUTE. CONSULTER LE MARCHAND.

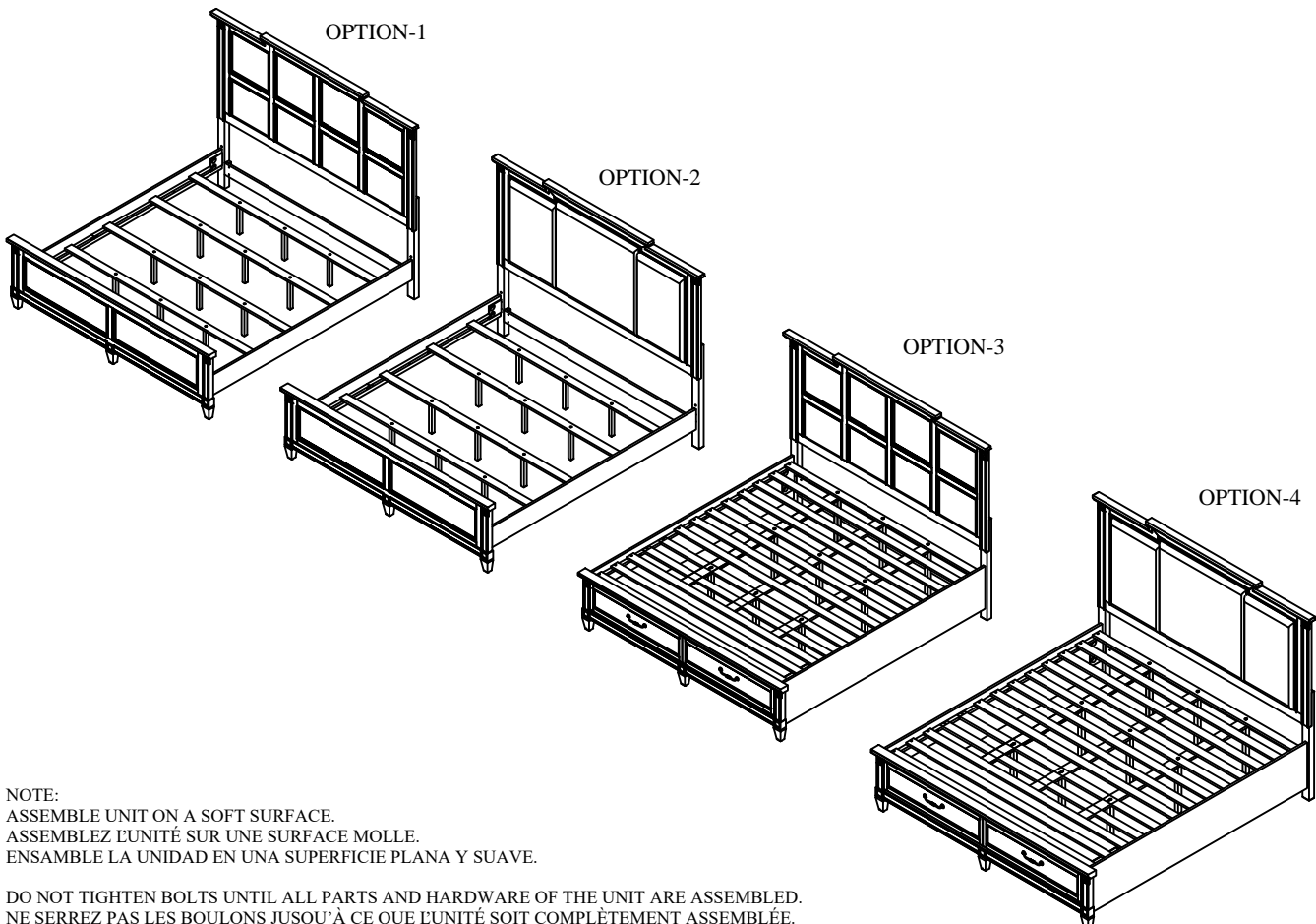









NOTE:
ASSEMBLE UNIT ON A SOFT SURFACE.
ASSEMBLEZ L'UNITÉ SUR UNE SURFACE MOLLE.
ENSAMBLE LA UNIDAD EN UNA SUPERFICIE PLANA Y SUAVE.

DO NOT TIGHTEN BOLTS UNTIL ALL PARTS AND HARDWARE OF THE UNIT ARE ASSEMBLED.
NE SERREZ PAS LES BOULONS JUSQU'À CE QUE L'UNITÉ SOIT COMPLÈTEMENT ASSEMBLÉE.
NO APRIETE LOS TORNILLOS HASTA QUE LA UNIDAD ESTE COMPLETAMENTE ENSAMBLADA









ASSEMBLY INSTRUCTIONS INSTRUCTIONS DE MONTAGE INSTRUCCIONES DE MONTAJE

KING PANEL BED
KING UPHOLSTERY BED
KING PANEL BED W/STORAGE FOOTBOARD
KING UPHOLSTERY BED W/STORAGE FOOTBOARD

LIST OF PARTS AND HARDWARE/ LISTE DES PIÈCES ET DU MATÉRIEL/ LISTA DE PIEZAS Y HARDWARE

NO#/ NOMBRE/ NÚMERO	DESCRIPTION/ DESCRIPTION/ DESCRIPCIÓN		QUANTITY/ QUANTITÉ/ CANTIDAD
A	BOLT/ BOULON/ TORNILLO $\frac{5}{16}$ " DIAMETER x $4\frac{1}{2}$ " LENGTH		8 PCS
B	LOCK WASHER "C"/ RONDELLE DE BLOCAGE "C"/ ARANDELA DE BLOQUEO "C" $\frac{5}{16}$ " DIAMETER		8 PCS
C	NUT/ ÉCROU/ NUEZ $\frac{5}{16}$ " DIAMETER		8 PCS
D	WRENCH/ CLÉ/ LLAVE INGLESA $\frac{1}{2}$ "		1 PC
E	FLAT WASHER/ RONDELLE PLATE/ ARANDELA PLANA $\frac{5}{16}$ " DIAMETER x $\frac{3}{4}$ " x $\frac{1}{16}$ "		8 PCS
F	LOCK WASHER/ RONDELLE DE BLOCAGE/ ARANDELA DE BLOQUEO $\frac{5}{16}$ " DIAMETER x $\frac{1}{2}$ " x $\frac{1}{16}$ "		8 PCS
G	BOLT/ BOULON/ TORNILLO $\frac{5}{16}$ " DIAMETER x $1\frac{3}{4}$ " LENGTH		8 PCS
I	SCREW/ VIS/ TORNILLO (54F) M4 x $1\frac{1}{4}$ " LENGTH		8 PCS
H	SCREW/ VIS/ TORNILLO (55F) M4 x $1\frac{1}{4}$ " LENGTH		29 PCS

LIST OF PARTS AND HARDWARE/ LISTE DES PIÈCES ET DU MATÉRIEL/ LISTA DE PIEZAS Y HARDWARE

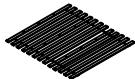
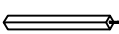
NO#/ NOMBRE/ NÚMERO	DESCRIPTION/ DESCRIPTION/ DESCRIPCIÓN		QUANTITY/ QUANTITÉ/ CANTIDAD
1	HEADBOARD PANEL/PANNEAU DE TÊTE DE LIT/PANEL DE CABECERO		1 PC
2	KD LEFT HEADBOARD LEG/JAMBE GAUCHE DE TÊTE DE LIT KD/ PATA IZQUIERDA KD PARA CABEZERA (L)		1 PC
3	KD RIGHT HEADBOARD LEG/JAMBE DROITE DE TÊTE DE LIT KD/ PATA DERECHA KD PARA CABEZERA (R)		1 PC
4	BOTTOM STRETCHER/ÉTIREUSE INFÉRIEURE/CAMILLA INFERIOR		1 PC
5	FOOTBOARD/ PIED DE LIT/ ESTRIBO		1 PC
6	SIDE RAIL / RAIL LATÉRAL / CARRIL LATERAL		2 PCS
7	SLAT/LAMELLE/LAMA (64F)		4 PCS
8	SLAT SUPPORT LEG/JAMBE DE SUPPORT À LATTES/ PATAS DE SOPORTE DE LAMAS (64F)		12 PCS
9	BOTTOM SLAT/LAME INFÉRIEURE/LLANTA INFERIOR (65F)		3 PCS
10	SLAT ROLL (INCLUDED 13 PCS)/ROULEAU DE FENTE/ ROLLO DE RANURA (65F)		1 SET
11	SLAT SUPPORT LEG/JAMBE DE SUPPORT À LATTES/ PATAS DE SOPORTE DE LAMAS (65F)		9 PCS

NOTE:
SPIRIT LEVELER NOT INCLUDED BUT NEEDED TO EVEN THE FLOOR.
SPIRIT LEVELER NON INCLUS MAIS NÉCESSAIRE MÊME LE SOL.
NIVELADOR DE ESPÍRITU NO INCLUIDO PERO ES NECESARIO PARA INCLUSO EL PISO.

ASSEMBLY INSTRUCTIONS INSTRUCTIONS DE MONTAGE INSTRUCCIONES DE MONTAJE

KING PANEL BED

Note:



OPTION-1

Step/ tape/ Paso 2

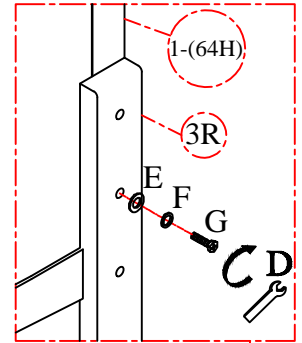

Step/ tape/ Paso 1

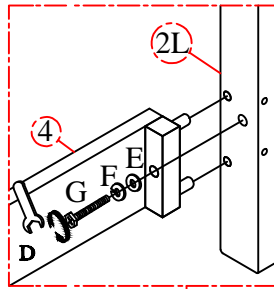

Step/ Étape/ Paso 6

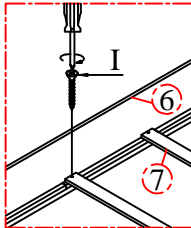

Step/ tape/ Paso 5

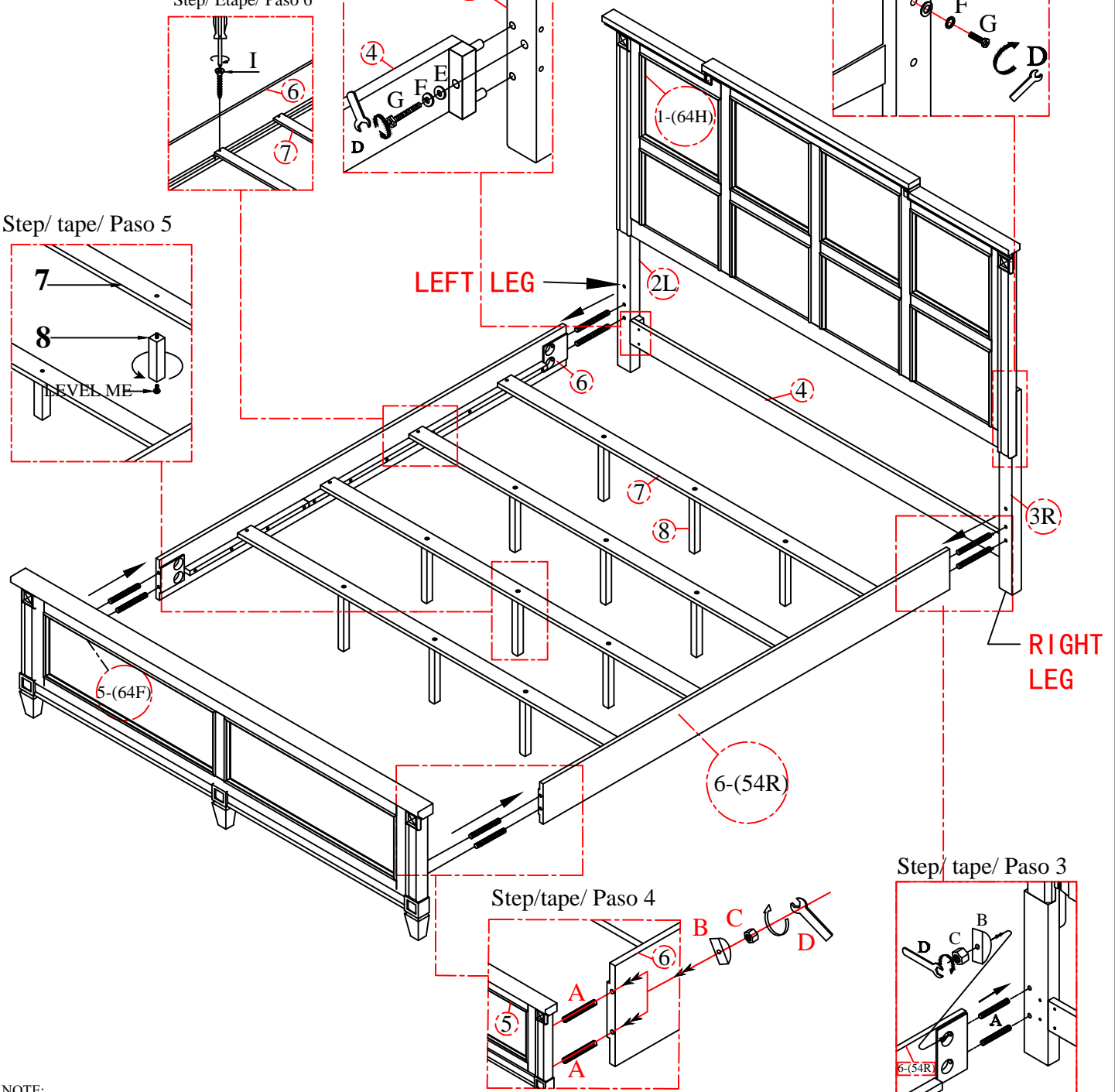
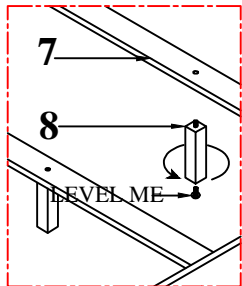

Step/tape/ Paso 4

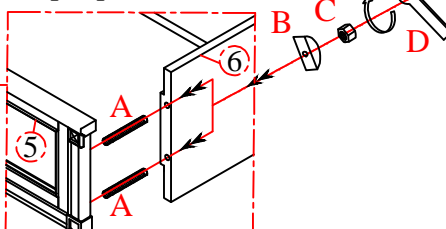

Step/ tape/ Paso 3

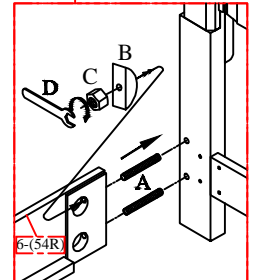

NOTE:
SPIRIT LEVELER NOT INCLUDED BUT NEEDED TO EVEN THE FLOOR.
SPIRIT LEVELER NON INCLUS MAIS NÉCESSAIRE MÊME LE SOL.
NIVELADOR DE ESPÍRITU NO INCLUIDO PERO ES NECESARIO PARA INCLUSO EL PISO.

ASSEMBLY INSTRUCTIONS INSTRUCTIONS DE MONTAGE INSTRUCCIONES DE MONTAJE

KING UPHOLSTERY BED

OPTION-2

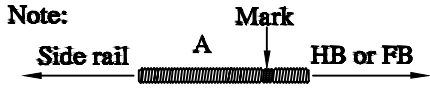

Step/tape/ Paso 2

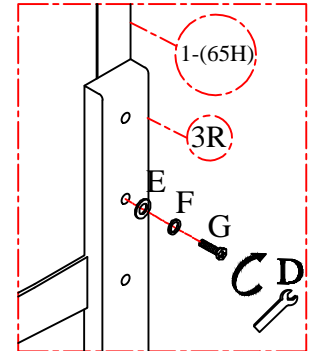

Step/ tape/ Paso 1

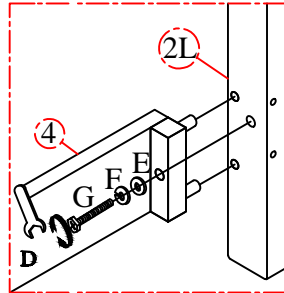

Step/ tape/ Paso 6

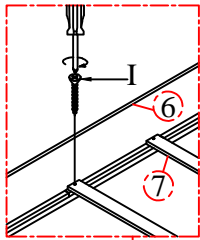

Step/tape/ Paso 5

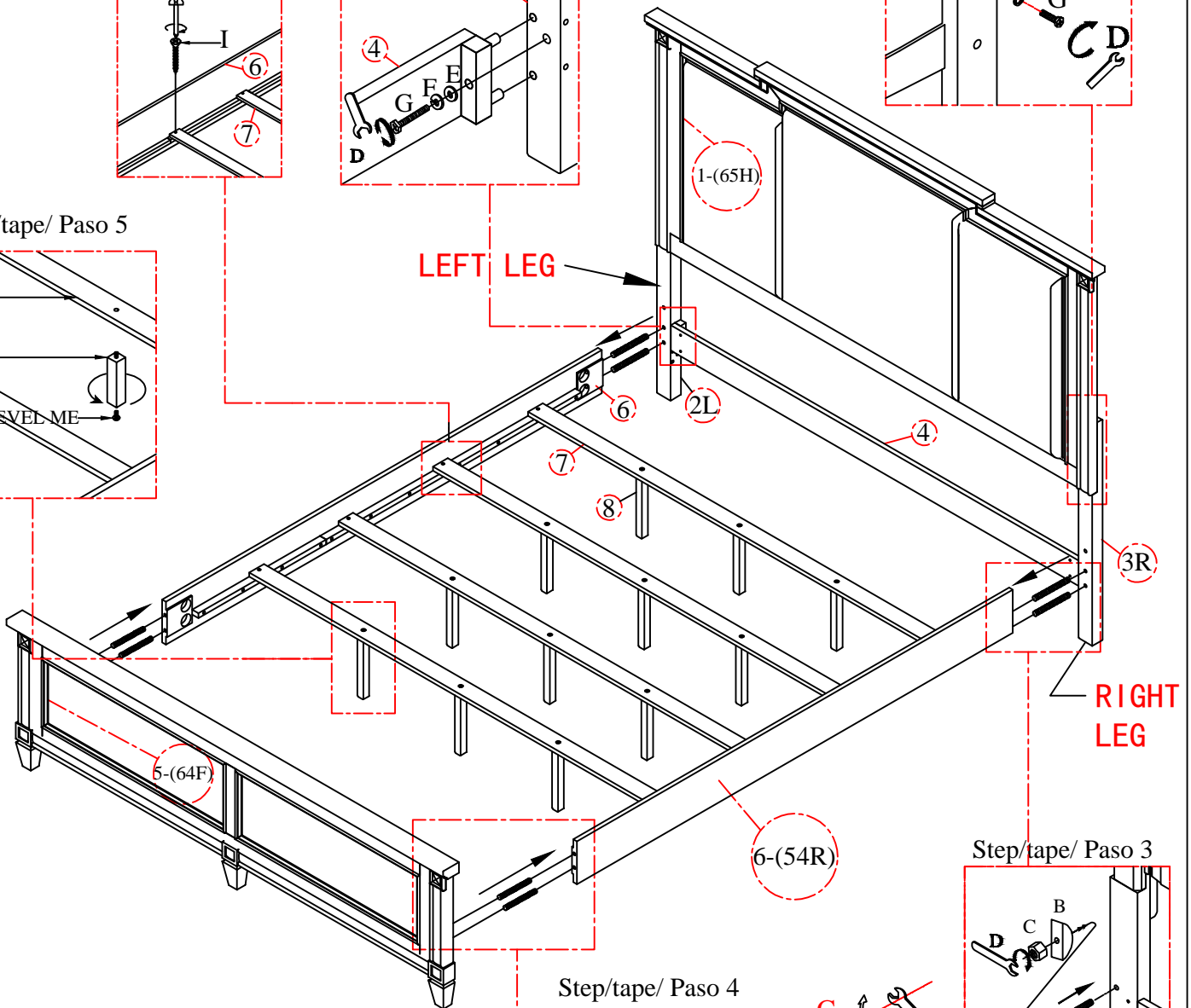
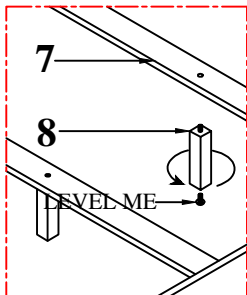

Step/tape/ Paso 3

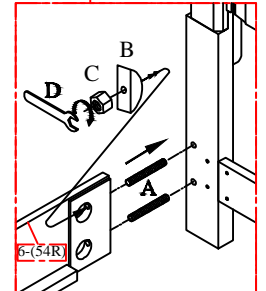

Step/tape/ Paso 4

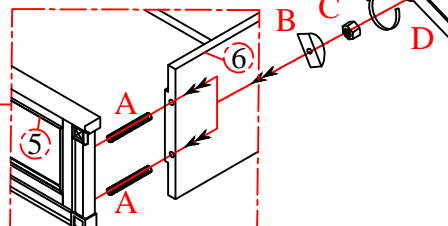

NOTE:
SPIRIT LEVELER NOT INCLUDED BUT NEEDED TO EVEN THE FLOOR.
SPIRIT LEVELER NON INCLUS MAIS NÉCESSAIRE MÊME LE SOL.
NIVELADOR DE ESPÍRITU NO INCLUIDO PERO ES NECESARIO PARA INCLUSO EL PISO.

ASSEMBLY INSTRUCTIONS

INSTRUCTIONS DE MONTAGE

INSTRUCCIONES DE MONTAJE

KING PANEL BED W/STORAGE FOOTBOARD

OPTION-3

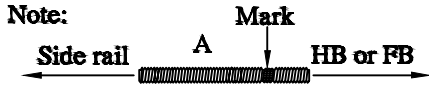

Step/tape/ Paso 2

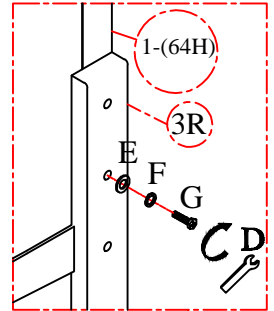

Step/tape/ Paso 6

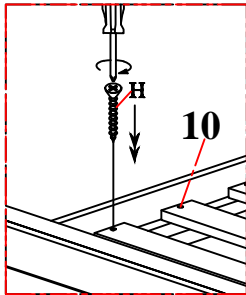

Step/tape/ Paso 1

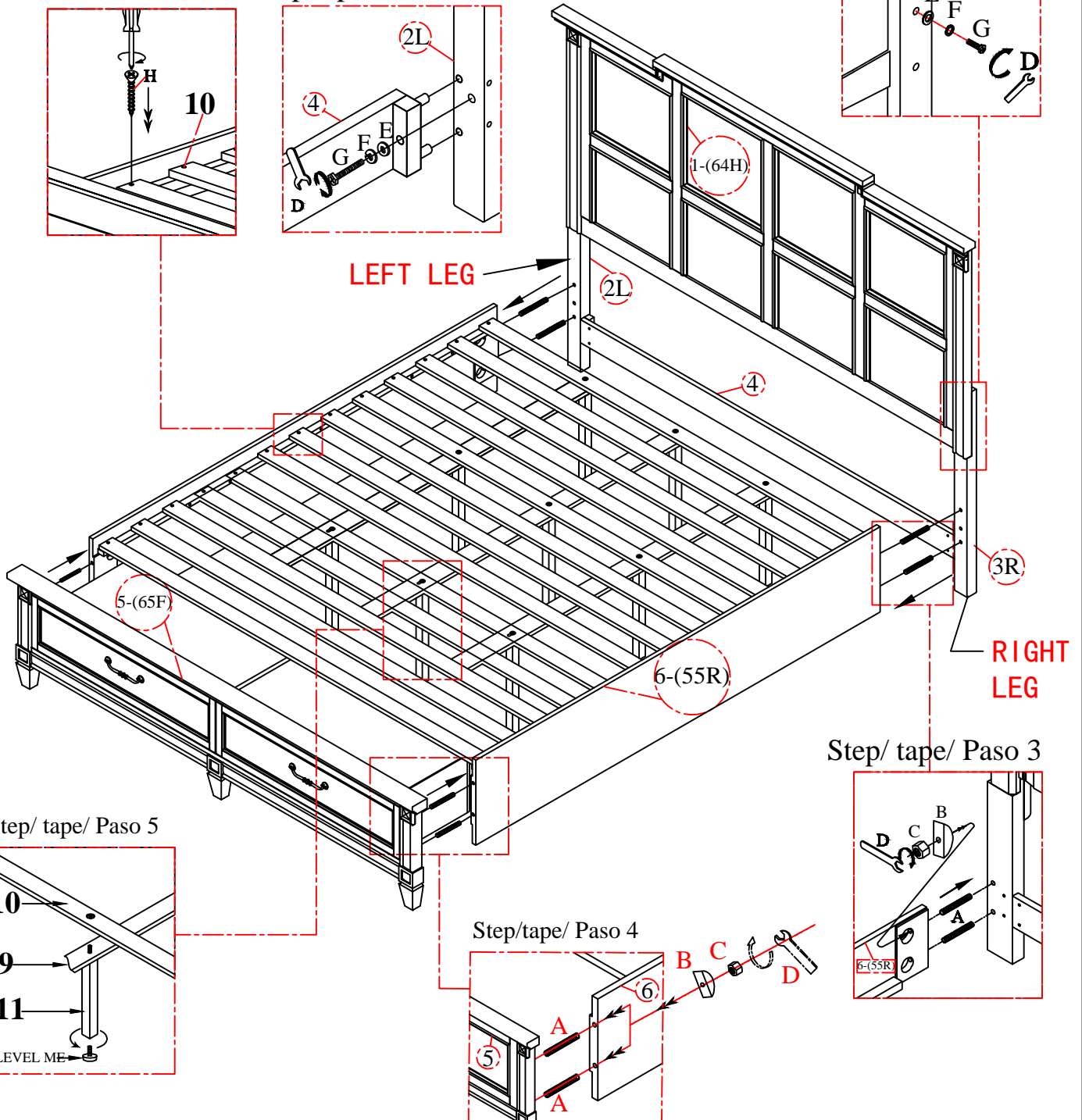
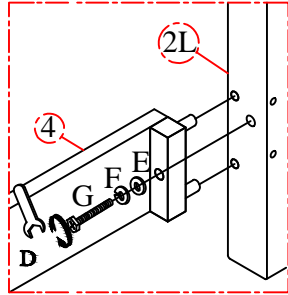

Step/ tape/ Paso 3

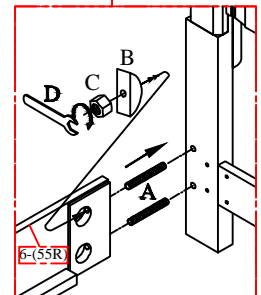

Step/tape/ Paso 4

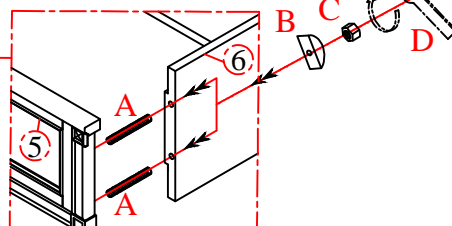

Step/ tape/ Paso 5

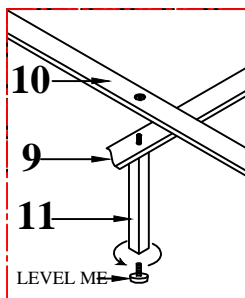

NOTE:
 SPIRIT LEVELER NOT INCLUDED BUT NEEDED TO EVEN THE FLOOR.
 SPIRIT LEVELER NON INCLUS MAIS NÉCESSAIRE MÊME LE SOL.
 NIVELADOR DE ESPÍRITU NO INCLUIDO PERO ES NECESARIO PARA INCLUSO EL PISO.

ASSEMBLY INSTRUCTIONS INSTRUCTIONS DE MONTAGE INSTRUCCIONES DE MONTAJE

KING UPHOLSTERY BED W/STORAGE FOOTBOARD

OPTION-4

Note:



Step/ tape/ Paso 2

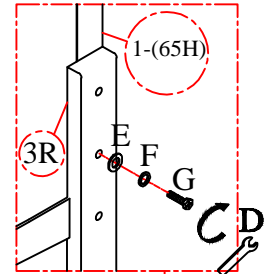

Step/ tape/ Paso 1

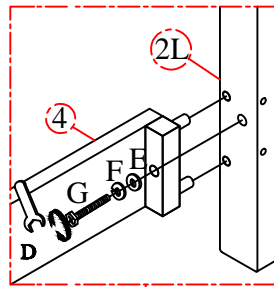

Step/ tape/ Paso 6

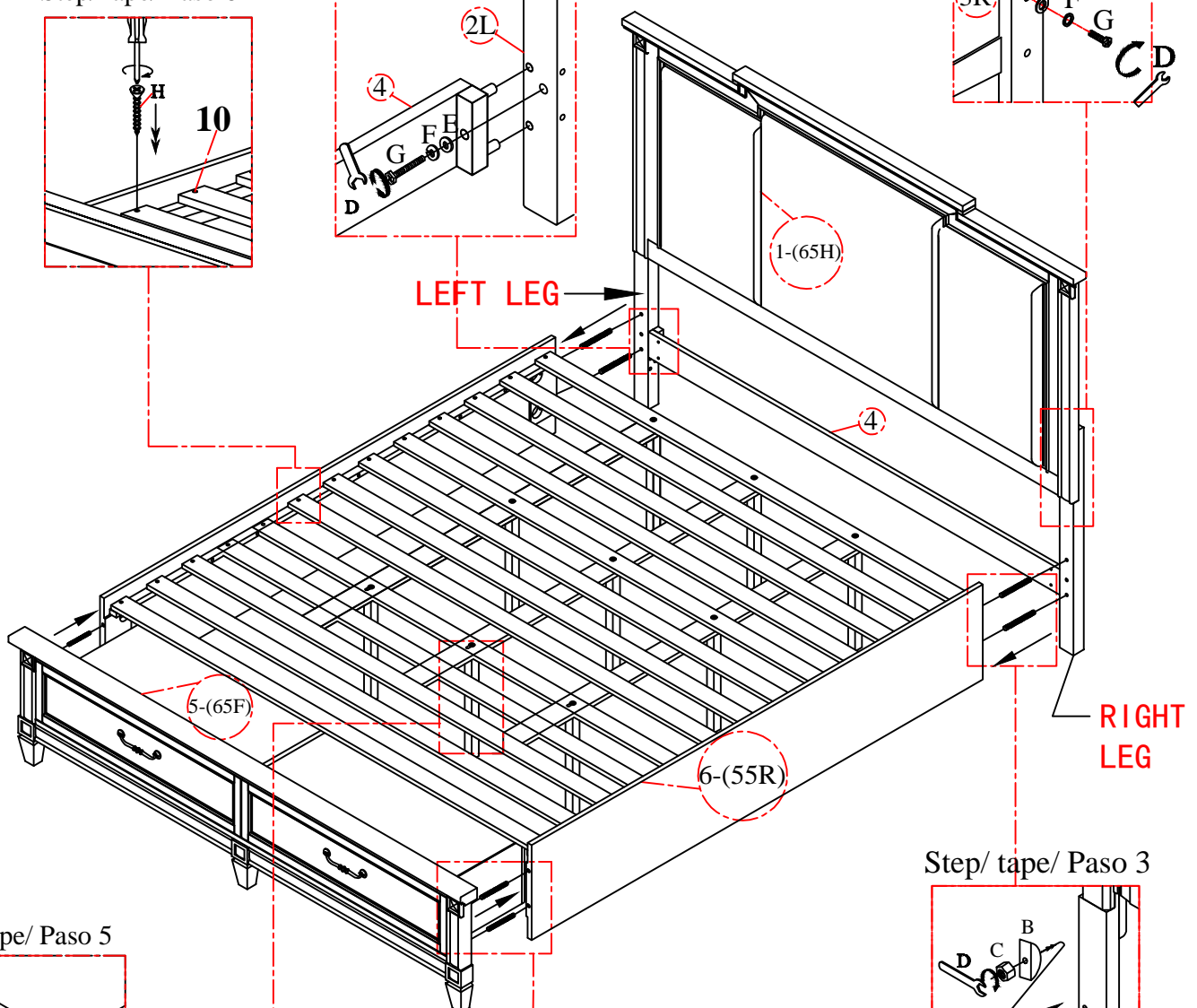
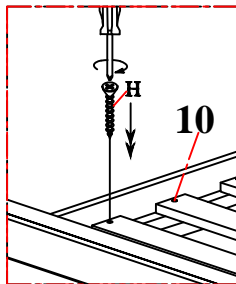

Step/ tape/ Paso 3

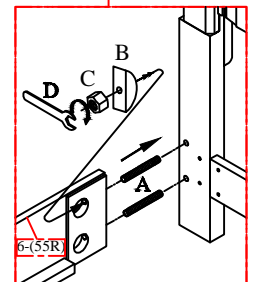

Step/ tape/ Paso 4

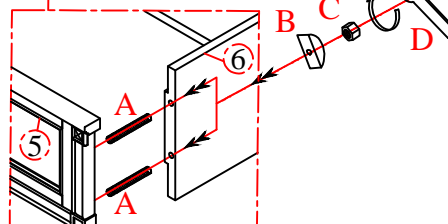

Step/ tape/ Paso 5

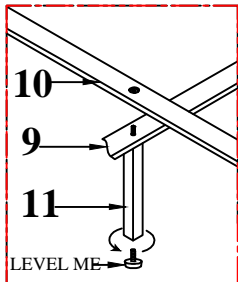

NOTE:
SPIRIT LEVELER NOT INCLUDED BUT NEEDED TO EVEN THE FLOOR.
SPIRIT LEVELER NON INCLUS MAIS NÉCESSAIRE MÊME LE SOL.
NIVELADOR DE ESPÍRITU NO INCLUIDO PERO ES NECESARIO PARA INCLUSO EL PISO.

ASSEMBLY INSTRUCTIONS

INSTRUCTIONS DE MONTAGE

INSTRUCCIONES DE MONTAJE

AL KING PANEL BED
CAL.KING UPHOLSTERY BED
CAL.KING PANEL BED WITH STORAGE FOOTBOARD
CAL.KING UPH. BED WITH STORAGE FOOTBOARD

CAUTION: PLEASE READ ALL INSTRUCTIONS BEFORE STARTING THE ASSEMBLY OF THIS PRODUCT. THESE PIECES ARE HEAVY. IN ORDER TO PREVENT PERSONAL INJURY AND ENSURE THAT THIS PRODUCT IS NOT DAMAGED DURING THE ASSEMBLY PROCESS, IT IS STRONGLY RECOMMENDED TO ENLIST THE ASSISTANCE OF ONE OR MORE PERSONS. IN CASE OF EXCESS STAIN, WIPE THE BOTTOM OF THE UNIT BEFORE PLACING ON ANY SURFACE.

ATTENTION: VEUILLEZ LIRE TOUTES LES INSTRUCTIONS AVANT DE COMMENCER L'ASSEMBLAGE DE CE PRODUIT. LES PIECES SONT LOURDES. POUR EVITER TOUTE BLESSURE ET POUR VOUS. ASSURER QUE LE PRODUIT N'EST PAS ENDOMMAGE' PENDANT L'ASSEMBLAGE, NOUS VOUS RECOMMANDONS DE FAIRE APPEL A UNE OU PLUSIEURS AUTRES PERSONNES. EN CAS DE TACHE EXCESSIVE, ESSUYEZ LE FOND DE L'UNITE' AVANT LE PLACEMENT SUR N'IMPORTE QUELLE SURFACE.

CUIDADO: FAVOR DE LEER TODAS LAS INSTRUCCIONES ANTES DE ENSAMBLAR SU PRODUCTO, ESTAS. PIEZAS SON PESADAS. PARA PREVENIR HERIDAS PERSONALES Y ASEGURAR QUE SU PRODUCTO NO SEA DAN ADO MIENTRAS ES ENSAMBLADO. SE RECOMIENDA LA ASISTENCIA DE UNA O MAUS PERSONAS.

WARNING: PROTECTIVE GLIDE IS PLACED UNDER EACH LEG OF THE FURNITURE TO RESIST SCRATCHES ON FLOOR SURFACE. SOME FLOOR SURFACES CAN BE EXTRA SENSITIVE TO SCRATCHES AND MARKINGS, IF YOU ARE NOT SURE CONSULT WITH YOUR DEALER.
AVERTISSEMENT. LES PIEDS DES MEUBLES SONT MUNIS DE PATINS DESTINES A PROTEGER LE PLANCHER. CERTAINS REVETEMENTS DE SOL PEUVENT ETRE TRES FRAGILES. EN CAS DE DOUTE. CONSULTER LE MARCHAND.

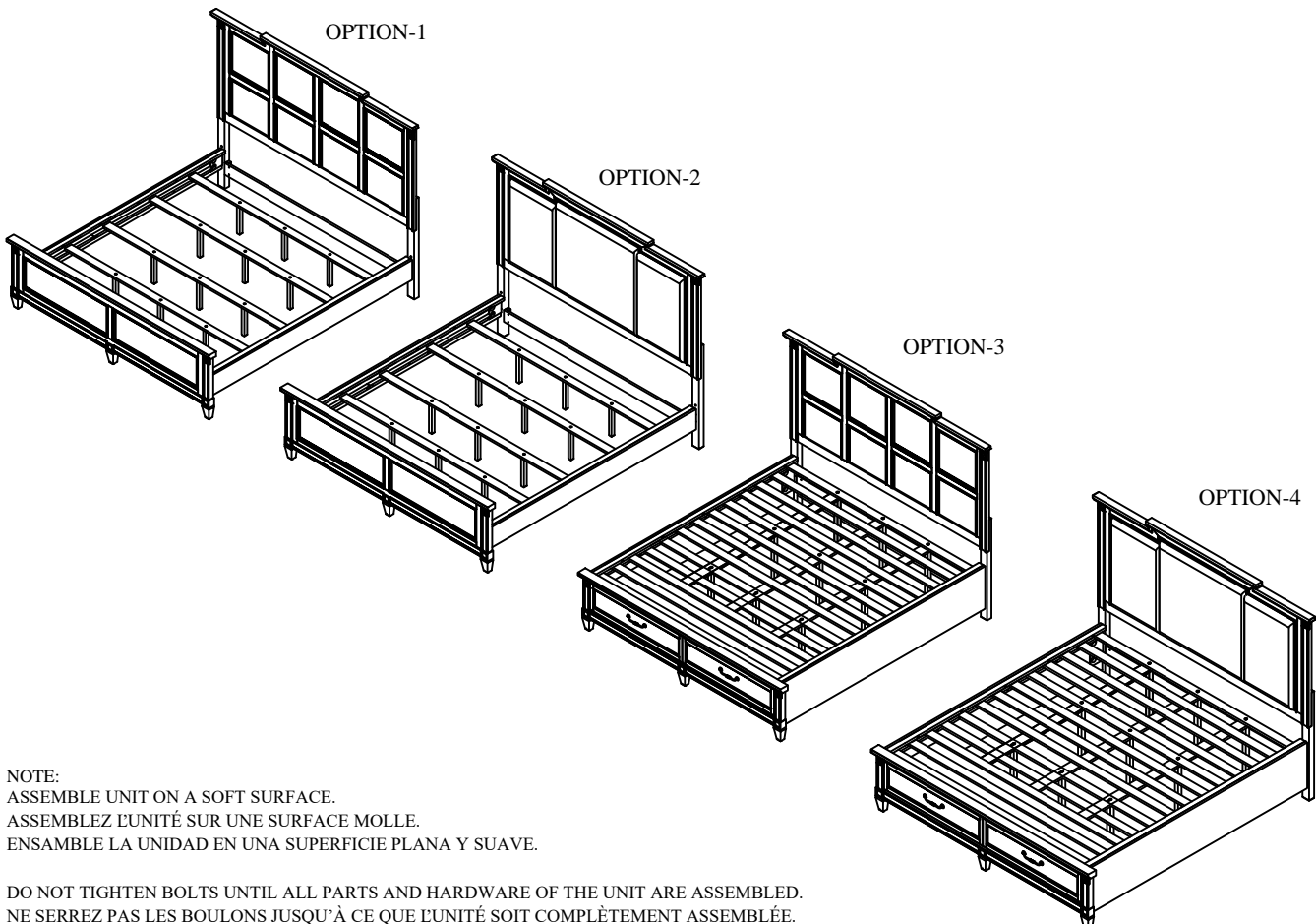













NOTE:
ASSEMBLE UNIT ON A SOFT SURFACE.
ASSEMBLEZ L'UNITÉ SUR UNE SURFACE MOLLE.
ENSAMBLE LA UNIDAD EN UNA SUPERFICIE PLANA Y SUAVE.

DO NOT TIGHTEN BOLTS UNTIL ALL PARTS AND HARDWARE OF THE UNIT ARE ASSEMBLED.
NE SERREZ PAS LES BOULONS JUSQU'À CE QUE L'UNITÉ SOIT COMPLÈTEMENT ASSEMBLÉE.
NO APRIETE LOS TORNILLOS HASTA QUE LA UNIDAD ESTE COMPLETAMENTE ENSAMBLADA









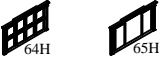

ASSEMBLY INSTRUCTIONS INSTRUCTIONS DE MONTAGE INSTRUCCIONES DE MONTAJE

AL KING PANEL BED
CAL.KING UPHOLSTERY BED
CAL.KING PANEL BED WITH STORAGE FOOTBOARD
CAL.KING UPH. BED WITH STORAGE FOOTBOARD

LIST OF PARTS AND HARDWARE/ LISTE DES PIÈCES ET DU MATÉRIEL/ LISTA DE PIEZAS Y HARDWARE

NO#/ NOMBRE/ NÚMERO	DESCRIPTION/ DESCRIPTION/ DESCRIPCIÓN		QUANTITY/ QUANTITÉ/ CANTIDAD
A	BOLT/ BOULON/ TORNILLO $\frac{5}{16}$ " DIAMETER x 4 $\frac{1}{2}$ " LENGTH		8 PCS
B	LOCK WASHER "C"/ RONDELLE DE BLOCAGE "C"/ ARANDELA DE BLOQUEO "C" $\frac{5}{16}$ " DIAMETER		8 PCS
C	NUT/ ÉCROU/ NUEZ $\frac{5}{16}$ " DIAMETER		8 PCS
D	WRENCH/ CLÉ/ LLAVE INGLESA $\frac{1}{2}$ "		1 PC
E	FLAT WASHER/ RONDELLE PLATE/ ARANDELA PLANA $\frac{5}{16}$ " DIAMETER x $\frac{3}{4}$ " x $\frac{1}{16}$ "		8 PCS
F	LOCK WASHER/ RONDELLE DE BLOCAGE/ ARANDELA DE BLOQUEO $\frac{5}{16}$ " DIAMETER x $\frac{1}{2}$ " x $\frac{1}{16}$ "		8 PCS
G	BOLT/ BOULON/ TORNILLO $\frac{5}{16}$ " DIAMETER x 1 $\frac{3}{4}$ " LENGTH		8 PCS
I	SCREW/ VIS/ TORNILLO (64F) M4 x 1 $\frac{1}{4}$ " LENGTH		8 PCS
H	SCREW/ VIS/ TORNILLO (65F) M4 x 1 $\frac{1}{4}$ " LENGTH		29 PCS
N	FLAT WASHER/ RONDELLE PLATE/ ARANDELA PLANA 1/4		10 PCS
M	LOCK WASHER/ RONDELLE DE BLOCAGE/ ARANDELA DE BLOQUEO 1/4		10 PCS
K	BOLT/ BOULON/ TORNILLO Φ 1/4*50mm		10 PCS
L	ALLEN		1 PC

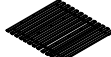
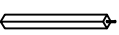
LIST OF PARTS AND HARDWARE/ LISTE DES PIÈCES ET DU MATÉRIEL/ LISTA DE PIEZAS Y HARDWARE

NO#/ NOMBRE/ NÚMERO	DESCRIPTION/ DESCRIPTION/ DESCRIPCIÓN		QUANTITY/ QUANTITÉ/ CANTIDAD
1	HEADBOARD PANEL/PANNEAU DE TÊTE DE LIT/PANEL DE CABECERO		1 PC
2	KD LEFT HEADBOARD LEG/ JAMBE GAUCHE DE TÊTE DE LIT KD/ PATA IZQUIERDA KD PARA CABEZERA (L)		1 PC
3	KD RIGHT HEADBOARD LEG/ JAMBE DROITE DE TÊTE DE LIT KD/ PATA DERECHA KD PARA CABEZERA (R)		1 PC
4	BOTTOM STRETCHER/ÉTIREUSE INFÉRIEURE/CAMILLA INFERIOR		1 PC
5	FOOTBOARD/ PIED DE LIT/ ESTRIBO		1 PC
6	SIDE RAIL / RAIL LATÉRAL / CARRIL LATERAL		2 PCS
7	SLAT/LAMELLE/LAMA (64F)		4 PCS
8	SLAT SUPPORT LEG/JAMBE DE SUPPORT À LATTES/ PATAS DE SOPORTE DE LAMAS (64F)		12 PCS
9	BOTTOM SLAT/LAME INFÉRIEURE/LLANTA INFERIOR (65F)		3 PCS
10	SLAT ROLL (INCLUDED 13 PCS)/ROULEAU DE FENTE/ ROLLO DE RANURA (65F)		1 SET
11	SLAT SUPPORT LEG/JAMBE DE SUPPORT À LATTES/ PATAS DE SOPORTE DE LAMAS (65F)		9 PCS
12	THE WIDER OF TOP RAILS		2 PCS

NOTE:
SPIRIT LEVELER NOT INCLUDED BUT NEEDED TO EVEN THE FLOOR.
SPIRIT LEVELER NON INCLUS MAIS NÉCESSAIRE MÊME LE SOL.
NIVELADOR DE ESPÍRITU NO INCLUIDO PERO ES NECESARIO PARA INCLUSO EL PISO.

ASSEMBLY INSTRUCTIONS INSTRUCTIONS DE MONTAGE INSTRUCCIONES DE MONTAJE

KING PANEL HEADBOARD
KING PANEL FOOTBOARD
CAL. KING PANEL BED RAILS

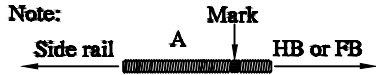

OPTION-1

Step/ tape/ Paso 2

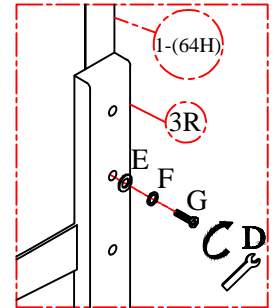

Step/ tape/ Paso 1

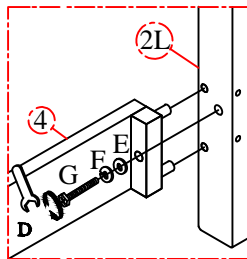

Step/ tape/ Paso 6

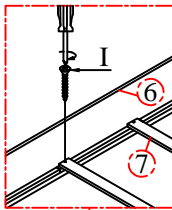

Step/ tape/ Paso 5

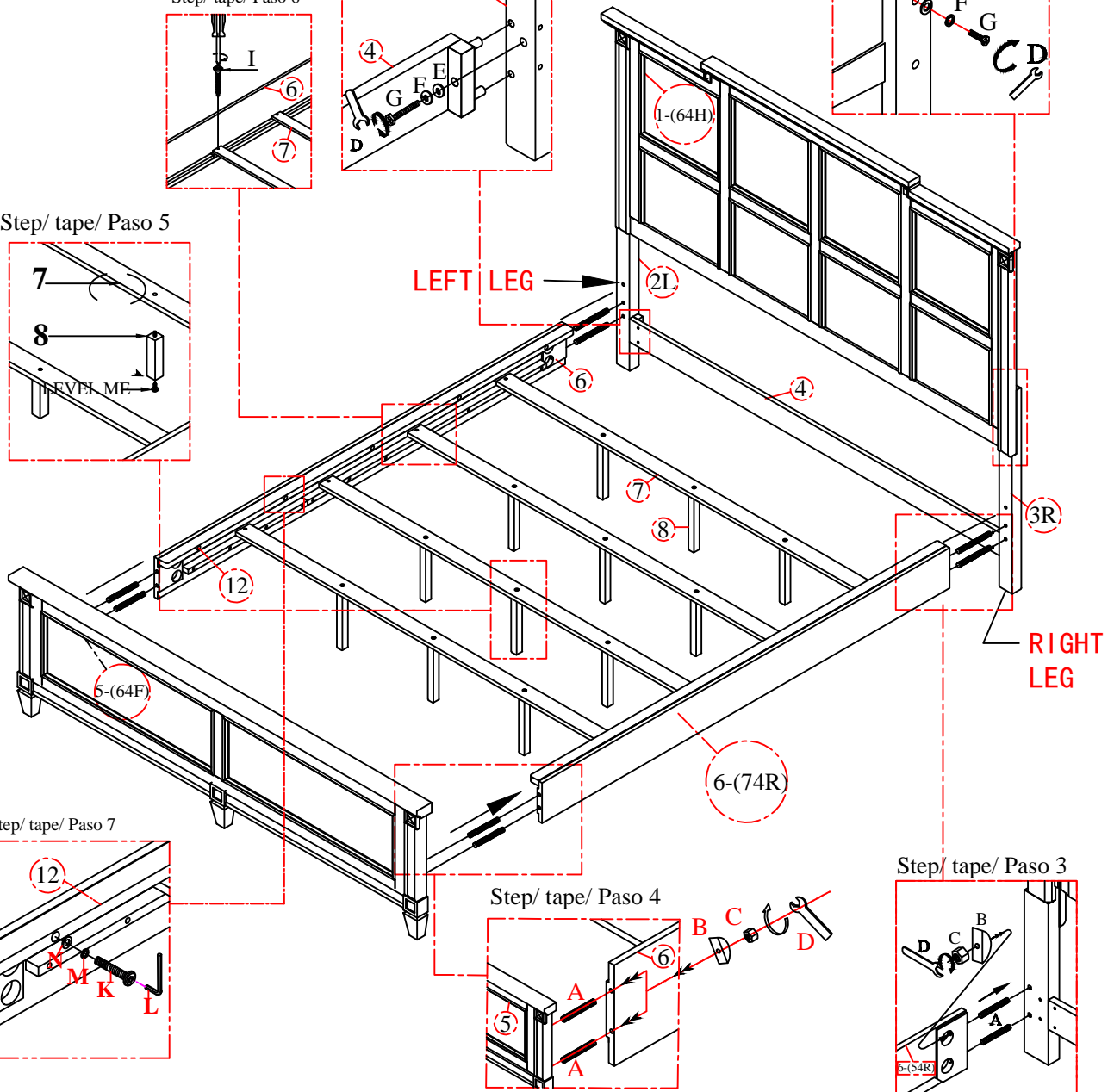
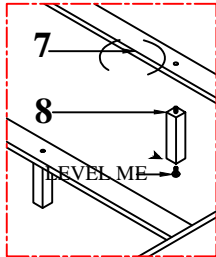

Step/ tape/ Paso 7

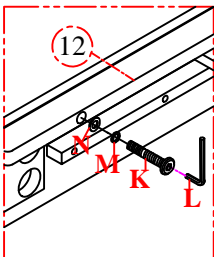

Step/ tape/ Paso 4

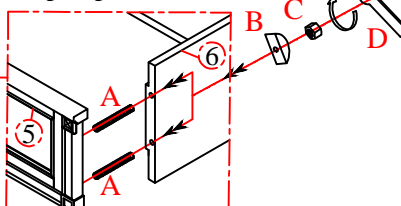

Step/ tape/ Paso 3

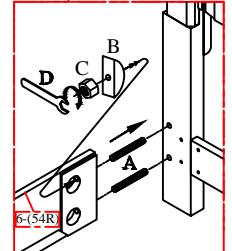

NOTE:
SPIRIT LEVELER NOT INCLUDED BUT NEEDED TO EVEN THE FLOOR.
SPIRIT LEVELER NON INCLUS MAIS NÉCESSAIRE MÊME LE SOL.
NIVELADOR DE ESPÍRITU NO INCLUIDO PERO ES NECESARIO PARA INCLUSO EL PISO.

ASSEMBLY INSTRUCTIONS INSTRUCTIONS DE MONTAGE INSTRUCCIONES DE MONTAJE

KING UPHOLSTERY HEADBOARD
KING PANEL FOOTBOARD
CAL. KING PANEL BED RAILS

Note:



OPTION-2

Step/ tape/ Paso 2

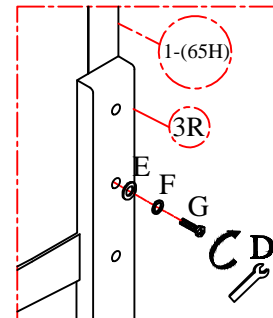

Step/ tape/ Paso 1

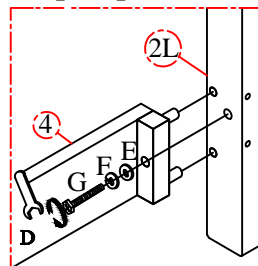

Step/ tape/ Paso 6

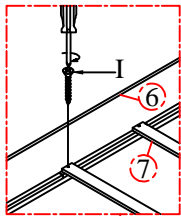

Step/ tape/ Paso 5

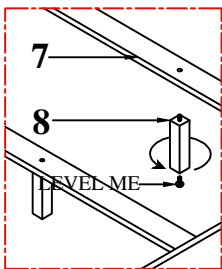

LEFT LEG

RIGHT LEG

Step/ tape/ Paso 7

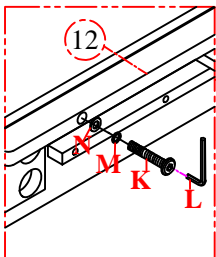

Step/ tape/ Paso 4

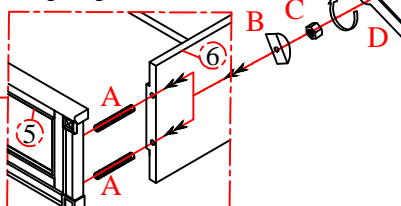

Step/ tape/ Paso 3

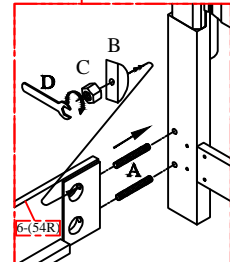

NOTE:
SPIRIT LEVELER NOT INCLUDED BUT NEEDED TO EVEN THE FLOOR.
SPIRIT LEVELER NON INCLUS MAIS NÉCESSAIRE MÊME LE SOL.
NIVELADOR DE ESPÍRITU NO INCLUIDO PERO ES NECESARIO PARA INCLUSO EL PISO.

ASSEMBLY INSTRUCTIONS INSTRUCTIONS DE MONTAGE INSTRUCCIONES DE MONTAJE

KING PANEL EADB A D
KING AGE B A D
AL KING PANEL BED AIL AGE B A D

OPTION-3

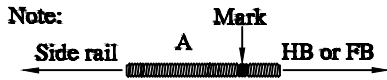

Step/ tape/ Paso 2

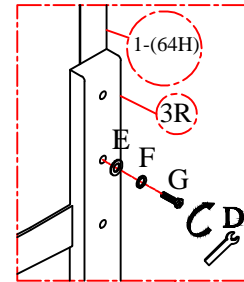

Step/ tape/ Paso 6

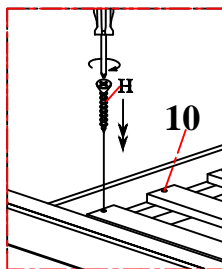

Step/ tape/ Paso 1

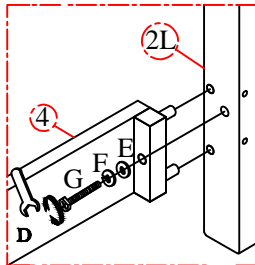

Step/ tape/ Paso 5

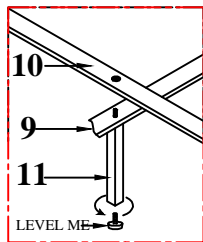

LEFT LEG

RIGHT LEG

Step/ tape/ Paso 3

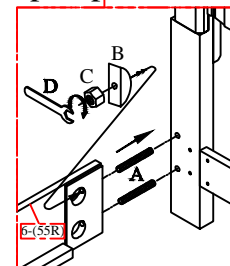

Step/ tape/ Paso 4

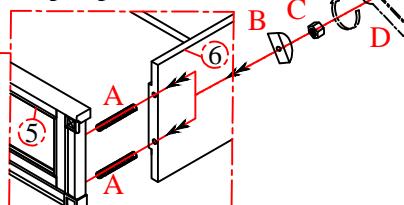

Step/ tape/ Paso 7

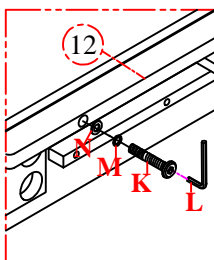

NOTE:
SPIRIT LEVELER NOT INCLUDED BUT NEEDED TO EVEN THE FLOOR.
SPIRIT LEVELER NON INCLUS MAIS NÉCESSAIRE MÊME LE SOL.
NIVELADOR DE ESPÍRITU NO INCLUIDO PERO ES NECESARIO PARA INCLUSO EL PISO.

ASSEMBLY INSTRUCTIONS INSTRUCTIONS DE MONTAGE INSTRUCCIONES DE MONTAJE

KING P L E EADB A D
KING AGE B A D
AL KING PANEL BED AIL AGE B A D

OPTION-4



Step/ tape/ Paso 2

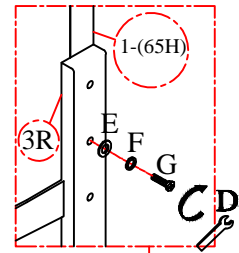

Step/ tape/ Paso 6

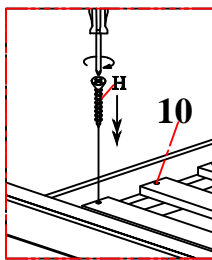

Step/ tape/ Paso 1

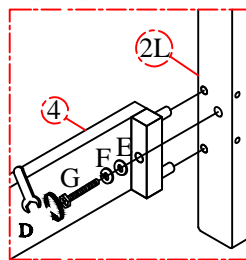

Step/ tape/ Paso 5

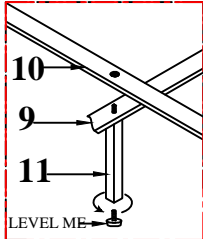

LEFT LEG

RIGHT LEG

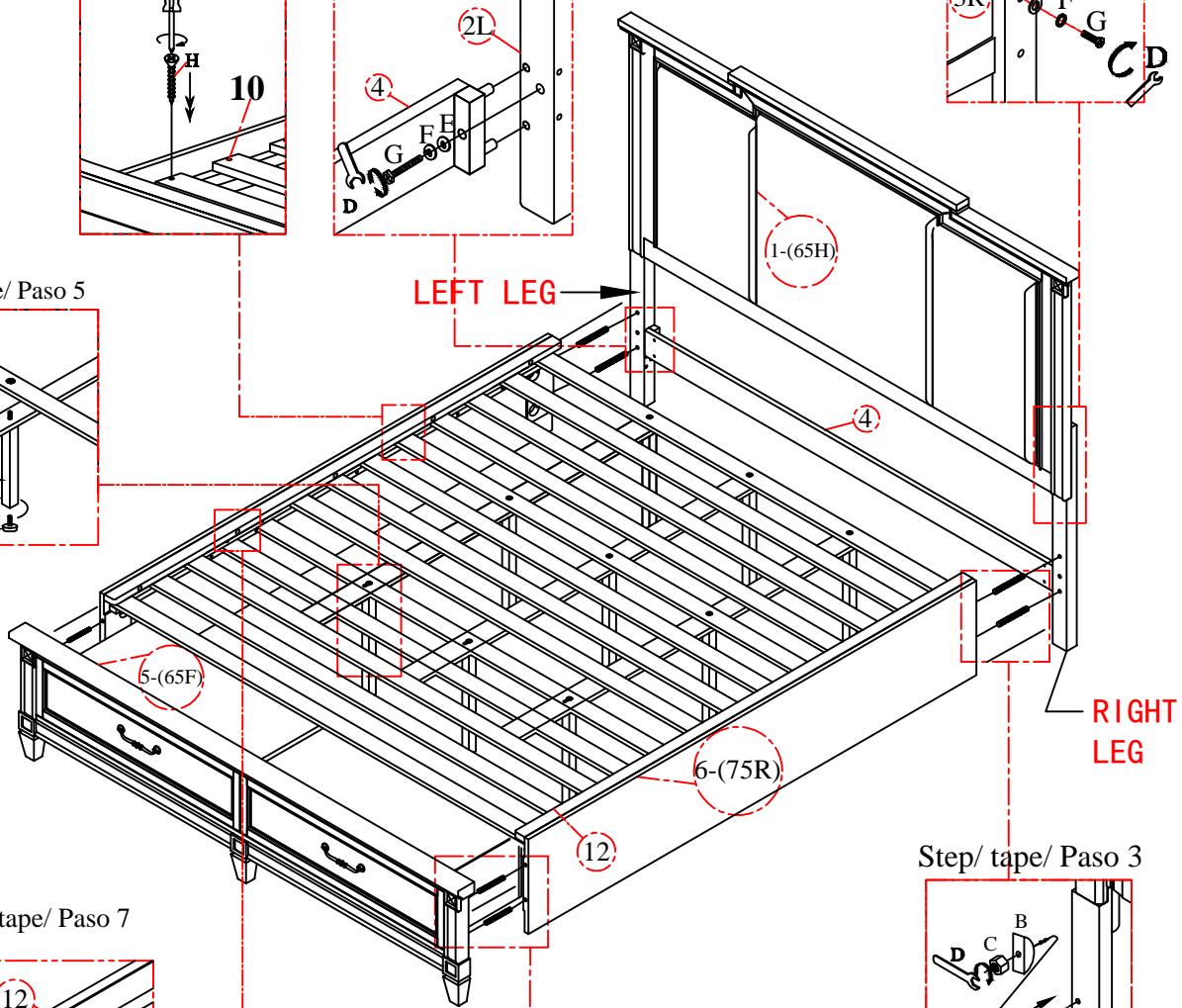

Step/ tape/ Paso 3

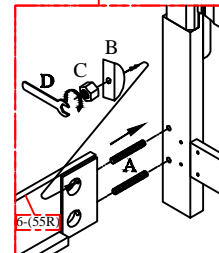

Step/ tape/ Paso 7

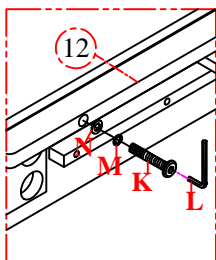

Step/ tape/ Paso 4

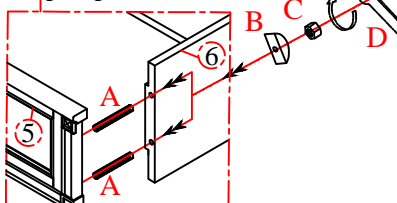

NOTE:
SPIRIT LEVELER NOT INCLUDED BUT NEEDED TO EVEN THE FLOOR.
SPIRIT LEVELER NON INCLUS MAIS NÉCESSAIRE MÊME LE SOL.
NIVELADOR DE ESPÍRITU NO INCLUIDO PERO ES NECESARIO PARA INCLUSO EL PISO.

ASSEMBLY INSTRUCTIONS INSTRUCTIONS DE MONTAGE INSTRUCCIONES DE MONTAJE

King Panel Headboard King Panel Footboard Cal.King Panel Bed Rails

CAUTION: PLEASE READ ALL INSTRUCTIONS BEFORE STARTING THE ASSEMBLY OF THIS PRODUCT. THESE PIECES ARE HEAVY. IN ORDER TO PREVENT PERSONAL INJURY AND ENSURE THAT THIS PRODUCT IS NOT DAMAGED DURING THE ASSEMBLY PROCESS, IT IS STRONGLY RECOMMENDED TO ENLIST THE ASSISTANCE OF ONE OR MORE PERSONS. IN CASE OF EXCESS STAIN, WIPE THE BOTTOM OF THE UNIT BEFORE PLACING ON ANY SURFACE.

ATTENTION: VEUILLEZ LIRE TOUTES LES INSTRUCTIONS AVANT DE COMMENCER L'ASSEMBLAGE DE CE PRODUIT. LES PIÈCES SONT LOURDES. POUR ÉVITER TOUTE BLESSURE ET POUR VOUS ASSURER QUE LE PRODUIT N'EST PAS ENDOMMAGÉ PENDANT L'ASSEMBLAGE, NOUS VOUS RECOMMANDONS DE FAIRE APPEL À UNE OU PLUSIEURS AUTRES PERSONNES. EN CAS DE TACHE EXCESSIVE, ESSUYEZ LE FOND DE L'UNITÉ AVANT LE PLACEMENT SUR N'IMPORTE QUELLE SURFACE.

CUIDADO: FAVOR DE LEER TODAS LAS INSTRUCCIONES ANTES DE ENSAMBLAR SU PRODUCTO, ESTAS PIEZAS SON PESADAS. PARA PREVENIR HERIDAS PERSONALES Y ASEGURAR QUE SU PRODUCTO NO SEA DANADO MIENTRAS ES ENSAMBLADO. SE RECOMIENDA LA ASISTENCIA DE UNA O MÁS PERSONAS.

WARNING: PROTECTIVE GLIDE IS PLACED UNDER EACH LEG OF THE FURNITURE TO RESIST SCRATCHES ON FLOOR SURFACE. SOME FLOOR SURFACES CAN BE EXTRA SENSITIVE TO SCRATCHES AND MARKINGS, IF YOU ARE NOT SURE CONSULT WITH YOUR DEALER.
AVERTISSEMENT. LES PIEDS DES MEUBLES SONT MUNIS DE PATINS DESTINÉS À PROTÉGER LE PLANCHER. CERTAINS REVÊTEMENTS DE SOL PEUVENT ÊTRE TRÈS FRAGILES. EN CAS DE DOUTE, CONSULTEZ LE MARCHAND.

LIST OF PARTS AND HARDWARE/ LISTE DES PIÈCES ET DU MATÉRIEL/ LISTA DE PIEZAS Y HARDWARE

NO#/ NOMBRE/ NÚMERO	DESCRIPTION/ DESCRIPTION/ DESCRIPCIÓN		QUANTITY/ QUANTITÉ/ CANTIDAD
A	BOLT/ BOULON/ TORNILLO Φ 5/16"*115mm		8PCS
B	LOCK WASHER/ RONDELLE DE BLOCAGE/ ARANDELA DE BLOQUEO Φ 5/16"*1,8mm		8PCS
C	FLAT WASHER/ RONDELLE PLATE/ ARANDELA PLANA Φ 5/16"		8PCS
D	WRENCH/ CLÉ/ LLAVE INGLESA		1 PC
E	LEVELER/NIVELEUR/NIVELADOR		12PCS
F	NUT/ ÉCROU/ NUEZ Φ 5/16"*16mm		8PCS
G	CURVED WASHER/ RONDELLE COURBÉE/ ARANDELA CURVA Φ 5/16"		8PCS
H	SCREW/VIS/TORNILLO #8*32mm		8PCS
K	BOLT/ BOULON/ TORNILLO Φ 5/16"*38mm		8PCS
I	BOLT/ BOULON/ TORNILLO Φ 1/4"*50mm		10PCS
L	ALLEN WRENCH/ CLÉ ALLEN/ LLAVE ALLEN		1 PC
M	LOCK WASHER/ RONDELLE DE BLOCAGE/ ARANDELA DE BLOQUEO Φ 1/4" * 1,5 mm		10PCS
N	FLAT WASHER/ RONDELLE PLATE/ ARANDELA PLANA Φ 1/4"		10PCS

LIST OF PARTS AND HARDWARE/ LISTE DES PIÈCES ET DU MATÉRIEL/ LISTA DE PIEZAS Y HARDWARE

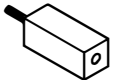
NO#/ NOMBRE/ NÚMERO	DESCRIPTION/ DESCRIPTION/ DESCRIPCIÓN		QUANTITY/ QUANTITÉ/ CANTIDAD
1	SLAT/ LATTE/ LISTÓN		4PCS
2	SUPPORT LEG/JAMBE D'APPUI/ PIERNA DE APOYO 260*28*28 mm		12PCS

NOTE:
ASSEMBLE UNIT ON A SOFT SURFACE.
ASSEMBLEZ L'UNITÉ SUR UNE SURFACE MOLLE.
ENSAMBLE LA UNIDAD EN UNA SUPERFICIE PLANA Y SUAVE.
DO NOT TIGHTEN BOLTS UNTIL THE UNIT IS COMPLETELY ASSEMBLED.
NE SERREZ PAS LES BOULONS JUSQU'À CE QUE L'UNITÉ SOIT COMPLÈTEMENT ASSEMBLÉE.
NO APRIETE LOS TORNILLOS HASTA QUE LA UNIDAD ESTE COMPLETAMENTE ENSAMBLADA.

ASSEMBLY INSTRUCTIONS INSTRUCTIONS DE MONTAGE INSTRUCCIONES DE MONTAJE

King Panel Headboard King Panel Footboard Cal.King Panel Bed Rails

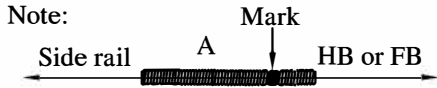

Step/ Étape/ Paso 2

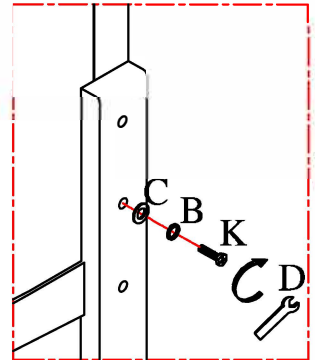

Step/ Étape/ Paso 1

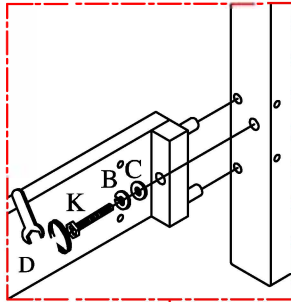

Step/ Étape/ Paso 5

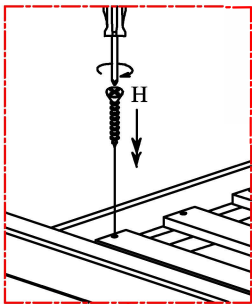

Step/ Étape/ Paso 4

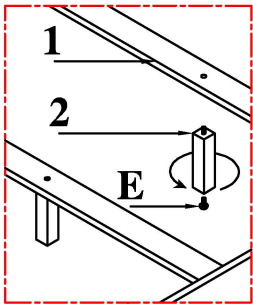

LEFT LEG

RIGHT LEG

Step/ Étape/ Paso 6

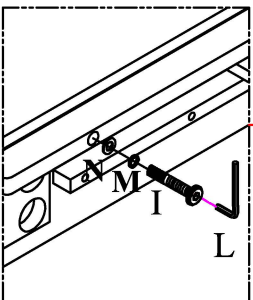

Step/ Étape/ Paso 3

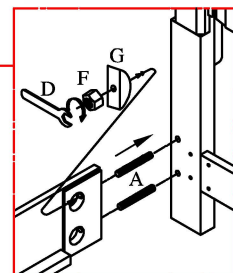

ASSEMBLY INSTRUCTIONS INSTRUCTIONS DE MONTAGE INSTRUCCIONES DE MONTAJE

King Panel Headboard King Storage Footboard Cal.King Panel Rails for Storage Footboard

CAUTION: PLEASE READ ALL INSTRUCTIONS BEFORE STARTING THE ASSEMBLY OF THIS PRODUCT. THESE PIECES ARE HEAVY. IN ORDER TO PREVENT PERSONAL INJURY AND ENSURE THAT THIS PRODUCT IS NOT DAMAGED DURING THE ASSEMBLY PROCESS, IT IS STRONGLY RECOMMENDED TO ENLIST THE ASSISTANCE OF ONE OR MORE PERSONS. IN CASE OF EXCESS STAIN, WIPE THE BOTTOM OF THE UNIT BEFORE PLACING ON ANY SURFACE.

ATTENTION: VEUILLEZ LIRE TOUTES LES INSTRUCTIONS AVANT DE COMMENCER L'ASSEMBLAGE DE CE PRODUIT. LES PIÈCES SONT LOURDES. POUR ÉVITER TOUTE BLESSURE ET POUR VOUS ASSURER QUE LE PRODUIT N'EST PAS ENDOMMAGÉ PENDANT L'ASSEMBLAGE, NOUS VOUS RECOMMANDONS DE FAIRE APPEL À UNE OU PLUSIEURS AUTRES PERSONNES. EN CAS DE TACHE EXCESSIVE, ESSUYEZ LE FOND DE L'UNITÉ AVANT LE PLACEMENT SUR N'IMPORTE QUELLE SURFACE.



CUIDADO: FAVOR DE LEER TODAS LAS INSTRUCCIONES ANTES DE ENSAMBLAR SU PRODUCTO, ESTAS PIEZAS SON PESADAS. PARA PREVENIR HERIDAS PERSONALES Y ASEGURAR QUE SU PRODUCTO NO SEA DAÑADO MIENTRAS ES ENSAMBLADO. SE RECOMIENDA LA ASISTENCIA DE UNA O MÁS PERSONAS.

WARNING: PROTECTIVE GLIDE IS PLACED UNDER EACH LEG OF THE FURNITURE TO RESIST SCRATCHES ON FLOOR SURFACE. SOME FLOOR SURFACES CAN BE EXTRA SENSITIVE TO SCRATCHES AND MARKINGS, IF YOU ARE NOT SURE CONSULT WITH YOUR DEALER. AVERTISSEMENT. LES PIEDS DES MEUBLES SONT MUNIS DE PATINS DESTINÉS À PROTÉGER LE PLANCHER. CERTAINS REVÊTEMENTS DE SOL PEUVENT ÊTRE TRÈS FRAGILES. EN CAS DE DOUTE, CONSULTEZ LE MARCHAND.

LIST OF PARTS AND HARDWARE/ LISTE DES PIÈCES ET DU MATÉRIEL/ LISTA DE PIEZAS Y HARDWARE

NO#/ NOMBRE/ NÚMERO	DESCRIPTION/ DESCRIPTION/ DESCRIPCIÓN		QUANTITY/ QUANTITÉ/ CANTIDAD
A	BOLT/ BOULON/ TORNILLO $\Phi 5/16" * 115\text{mm}$		8 PCS
B	LOCK WASHER/ RONDELLE DE BLOCAGE/ ARANDELA DE BLOQUEO $\Phi 5/16" * 1,8\text{mm}$		8 PCS
C	FLAT WASHER/ RONDELLE PLATE/ ARANDELA PLANA $\Phi 5/16"$		8 PCS
D	WRENCH/ CLÉ/ LLAVE INGLESA		1 PC
E	LEVELER/NIVELEUR/NIVELADOR		9 PCS
F	NUT/ ÉCROU/ NUEZ $\Phi 5/16" * 16\text{mm}$		8 PCS
G	CURVED WASHER/ RONDELLE COURBÉE/ ARANDELA CURVA $\Phi 5/16"$		8 PCS
H	SCREW/VIS/TORNILLO #8*32mm		29 PCS
K	BOLT/ BOULON/ TORNILLO $\Phi 5/16" * 38\text{mm}$		8 PCS
I	BOLT/ BOULON/ TORNILLO $\Phi 1/4" * 50\text{mm}$		10 PCS
L	ALLEN WRENCH/ CLÉ ALLEN/ LLAVE ALLEN		1 PC
M	LOCK WASHER/ RONDELLE DE BLOCAGE/ ARANDELA DE BLOQUEO $\Phi 1/4" * 1,5\text{mm}$		10 PCS
N	FLAT WASHER/ RONDELLE PLATE/ ARANDELA PLANA $\Phi 1/4"$		10 PCS

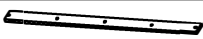
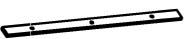
LIST OF PARTS AND HARDWARE/ LISTE DES PIÈCES ET DU MATÉRIEL/ LISTA DE PIEZAS Y HARDWARE

NO#/ NOMBRE/ NÚMERO	DESCRIPTION/ DESCRIPTION/ DESCRIPCIÓN		QUANTITY/ QUANTITÉ/ CANTIDAD
1	SLAT/ LATTE/ LISTÓN		13 PCS
2	BOTTOM SLAT/ LATTE DU BAS/ LISTÓN INFERIOR		3 PCS
3	SUPPORT LEG/JAMBE D'APPUI/ PIERNA DE APOYO 410*32*32mm		9 PCS

NOTE:
ASSEMBLE UNIT ON A SOFT SURFACE.
ASSEMBLEZ L'UNITÉ SUR UNE SURFACE MOLLE.
ENSAMBLE LA UNIDAD EN UNA SUPERFICIE PLANA Y SUAVE.
DO NOT TIGHTEN BOLTS UNTIL THE UNIT IS COMPLETELY ASSEMBLED.
NE SERREZ PAS LES BOULONS JUSQU'À CE QUE L'UNITÉ SOIT COMPLÈTEMENT ASSEMBLÉE.
NO APRIETE LOS TORNILLOS HASTA QUE LA UNIDAD ESTE COMPLETAMENTE ENSAMBLADA.

ASSEMBLY INSTRUCTIONS INSTRUCTIONS DE MONTAGE INSTRUCCIONES DE MONTAJE

King Panel Headboard King Storage Footboard Cal.King Panel Rails for Storage Footboard

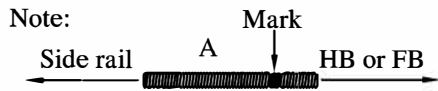

Step/ Étape/ Paso 2

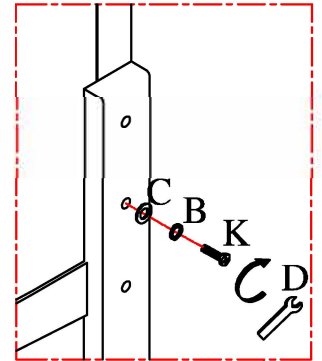

Step/ Étape/ Paso 5

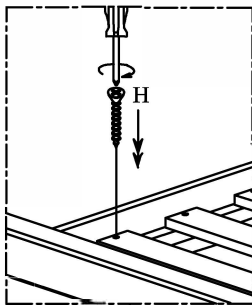

Step/ Étape/ Paso 1

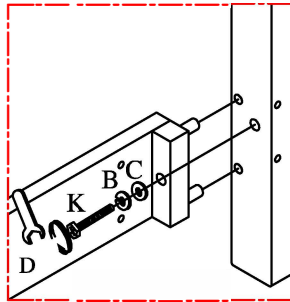

LEFT LEG

Step/ Étape/ Paso 4

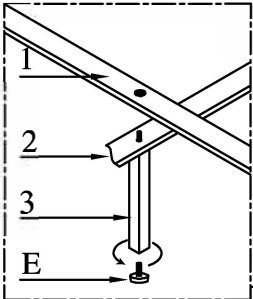

RIGHT LEG

Step/ Étape/ Paso 3

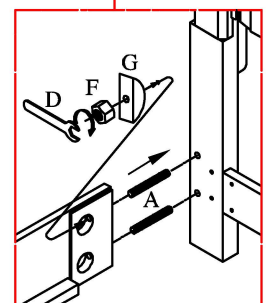

Step/ Étape/ Paso 6

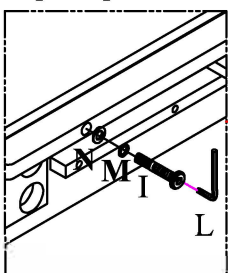

ASSEMBLY INSTRUCTIONS INSTRUCTIONS DE MONTAGE INSTRUCCIONES DE MONTAJE

K^B5668-65H+64F+74R ^{ard} King Panel Footboard Cal.King Panel Bed Rails

CAUTION: PLEASE READ ALL INSTRUCTIONS BEFORE STARTING THE ASSEMBLY OF THIS PRODUCT. THESE PIECES ARE HEAVY. IN ORDER TO PREVENT PERSONAL INJURY AND ENSURE THAT THIS PRODUCT IS NOT DAMAGED DURING THE ASSEMBLY PROCESS, IT IS STRONGLY RECOMMENDED TO ENLIST THE ASSISTANCE OF ONE OR MORE PERSONS. IN CASE OF EXCESS STAIN, WIPE THE BOTTOM OF THE UNIT BEFORE PLACING ON ANY SURFACE.

ATTENTION: VEUILLEZ LIRE TOUTES LES INSTRUCTIONS AVANT DE COMMENCER L'ASSEMBLAGE DE CE PRODUIT. LES PIÈCES SONT LOURDES. POUR ÉVITER TOUTE BLESSURE ET POUR VOUS ASSURER QUE LE PRODUIT N'EST PAS ENDOMMAGÉ PENDANT L'ASSEMBLAGE, NOUS VOUS RECOMMANDONS DE FAIRE APPEL À UNE OU PLUSIEURS AUTRES PERSONNES. EN CAS DE TACHE EXCESSIVE, ESSUYEZ LE FOND DE L'UNITÉ AVANT LE PLACEMENT SUR N'IMPORTE QUELLE SURFACE.

CUIDADO: FAVOR DE LEER TODAS LAS INSTRUCCIONES ANTES DE ENSAMBLAR SU PRODUCTO, ESTAS PIEZAS SON PESADAS. PARA PREVENIR HERIDAS PERSONALES Y ASEGURAR QUE SU PRODUCTO NO SEA DANADO MIENTRAS ES ENSAMBLADO. SE RECOMIENDA LA ASISTENCIA DE UNA O MAS PERSONAS.

WARNING: PROTECTIVE GLIDE IS PLACED UNDER EACH LEG OF THE FURNITURE TO RESIST SCRATCHES ON FLOOR SURFACE. SOME FLOOR SURFACES CAN BE EXTRA SENSITIVE TO SCRATCHES AND MARKINGS, IF YOU ARE NOT SURE CONSULT WITH YOUR DEALER.
AVERTISSEMENT. LES PIEDS DES MEUBLES SONT MUNIS DE PATINS DESTINÉS À PROTÉGER LE PLANCHER. CERTAINS REVÊTEMENTS DE SOL PEUVENT ÊTRE TRÈS FRAGILES. EN CAS DE DOUTE CONSULTER LE MARCHAND.

LIST OF PARTS AND HARDWARE/ LISTE DES PIÈCES ET DU MATÉRIEL/ LISTA DE PIEZAS Y HARDWARE

NO#/ NOMBRE/ NÚMERO	DESCRIPTION/ DESCRIPTION/ DESCRIPCIÓN		QUANTITY/ QUANTITÉ/ CANTIDAD
A	BOLT/ BOULON/ TORNILLO Φ 5/16"*115mm		8PCS
B	LOCK WASHER/ RONDELLE DE BLOCAGE/ ARANDELA DE BLOQUEO Φ 5/16"*1,8mm		8PCS
C	FLAT WASHER/ RONDELLE PLATE/ ARANDELA PLANA Φ 5/16"		8PCS
D	WRENCH/ CLÉ/ LLAVE INGLESA		1 PC
E	LEVELER/NIVELEUR/NIVELADOR		12PCS
F	NUT/ ÉCROU/ NUEZ Φ 5/16"*16mm		8PCS
G	CURVED WASHER/ RONDELLE COURBÉE/ ARANDELA CURVA Φ 5/16"		8PCS
H	SCREW/VIS/TORNILLO #8*32mm		8PCS
K	BOLT/ BOULON/ TORNILLO Φ 5/16"*38mm		8PCS
I	BOLT/ BOULON/ TORNILLO Φ 1/4"*50mm		10PCS
L	ALLEN WRENCH/ CLÉ ALLEN/ LLAVE ALLEN		1 PC
M	LOCK WASHER/ RONDELLE DE BLOCAGE/ ARANDELA DE BLOQUEO Φ 1/4" * 1,5 mm		10PCS
N	FLAT WASHER/ RONDELLE PLATE/ ARANDELA PLANA Φ 1/4"		10PCS

LIST OF PARTS AND HARDWARE/ LISTE DES PIÈCES ET DU MATÉRIEL/ LISTA DE PIEZAS Y HARDWARE

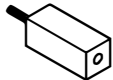
NO#/ NOMBRE/ NÚMERO	DESCRIPTION/ DESCRIPTION/ DESCRIPCIÓN		QUANTITY/ QUANTITÉ/ CANTIDAD
1	SLAT/ LATTE/ LISTÓN		4PCS
2	SUPPORT LEG/JAMBE D'APPUI/ PIERNA DE APOYO 260*28*28 mm		12PCS

NOTE:
ASSEMBLE UNIT ON A SOFT SURFACE.
ASSEMBLEZ L'UNITÉ SUR UNE SURFACE MOLLE.
ENSAMBLE LA UNIDAD EN UNA SUPERFICIE PLANA Y SUAVE.
DO NOT TIGHTEN BOLTS UNTIL THE UNIT IS COMPLETELY ASSEMBLED.
NE SERREZ PAS LES BOULONS JUSQU'À CE QUE L'UNITÉ SOIT COMPLÈTEMENT ASSEMBLÉE.
NO APRIETE LOS TORNILLOS HASTA QUE LA UNIDAD ESTE COMPLETAMENTE ENSAMBLADA.

ASSEMBLY INSTRUCTIONS INSTRUCTIONS DE MONTAGE INSTRUCCIONES DE MONTAJE

King Upholstered Headboard King Panel Footboard Cal.King Panel Bed Rails

Note:
Side rail A Mark HB or FB

Step/ Étape/ Paso 2

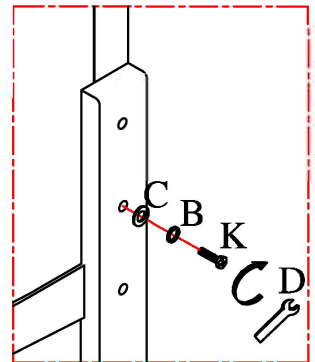

Step/ Étape/ Paso 1

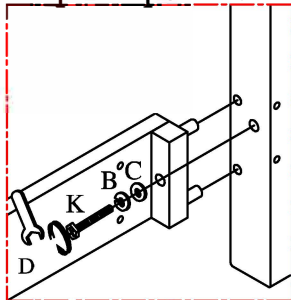

Step/ Étape/ Paso 5

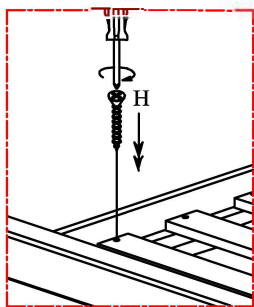

Step/ Étape/ Paso 4

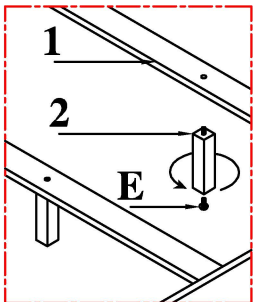

LEFT LEG

RIGHT LEG

Step/ Étape/ Paso 6

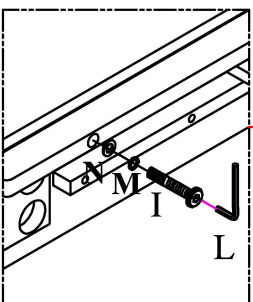

Step/ Étape/ Paso 3

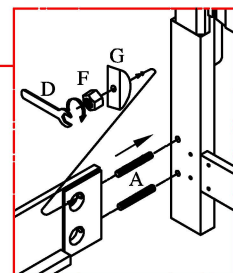

ASSEMBLY INSTRUCTIONS INSTRUCTIONS DE MONTAGE INSTRUCCIONES DE MONTAJE

King B5668-65H+65F+75R King Storage Footboard Cal.King Panel Rails for Storage Footboard

CAUTION: PLEASE READ ALL INSTRUCTIONS BEFORE STARTING THE ASSEMBLY OF THIS PRODUCT. THESE PIECES ARE HEAVY. IN ORDER TO PREVENT PERSONAL INJURY AND ENSURE THAT THIS PRODUCT IS NOT DAMAGED DURING THE ASSEMBLY PROCESS, IT IS STRONGLY RECOMMENDED TO ENLIST THE ASSISTANCE OF ONE OR MORE PERSONS. IN CASE OF EXCESS STAIN, WIPE THE BOTTOM OF THE UNIT BEFORE PLACING ON ANY SURFACE.

ATTENTION: VEUILLEZ LIRE TOUTES LES INSTRUCTIONS AVANT DE COMMENCER L'ASSEMBLAGE DE CE PRODUIT. LES PIÈCES SONT LOURDES. POUR ÉVITER TOUTE BLESSURE ET POUR VOUS ASSURER QUE LE PRODUIT N'EST PAS ENDOMMAGÉ PENDANT L'ASSEMBLAGE, NOUS VOUS RECOMMANDONS DE FAIRE APPEL À UNE OU PLUSIEURS AUTRES PERSONNES. EN CAS DE TACHE EXCESSIVE, ESSUYEZ LE FOND DE L'UNITÉ AVANT LE PLACEMENT SUR N'IMPORTE QUELLE SURFACE.



CUIDADO: FAVOR DE LEER TODAS LAS INSTRUCCIONES ANTES DE ENSAMBLAR SU PRODUCTO, ESTAS PIEZAS SON PESADAS. PARA PREVENIR HERIDAS PERSONALES Y ASEGURAR QUE SU PRODUCTO NO SEA DAÑADO MIENTRAS ES ENSAMBLADO. SE RECOMIENDA LA ASISTENCIA DE UNA O MÁS PERSONAS.

WARNING: PROTECTIVE GLIDE IS PLACED UNDER EACH LEG OF THE FURNITURE TO RESIST SCRATCHES ON FLOOR SURFACE. SOME FLOOR SURFACES CAN BE EXTRA SENSITIVE TO SCRATCHES AND MARKINGS, IF YOU ARE NOT SURE CONSULT WITH YOUR DEALER. AVERTISSEMENT. LES PIEDS DES MEUBLES SONT MUNIS DE PATINS DESTINÉS À PROTÉGER LE PLANCHER. CERTAINS REVÊTEMENTS DE SOL PEUVENT ÊTRE TRÈS FRAGILES. EN CAS DE DOUTE CONSULTER LE MARCHAND.

LIST OF PARTS AND HARDWARE/ LISTE DES PIÈCES ET DU MATÉRIEL/ LISTA DE PIEZAS Y HARDWARE

NO#/ NOMBRE/ NÚMERO	DESCRIPTION/ DESCRIPTION/ DESCRIPCIÓN		QUANTITY/ QUANTITÉ/ CANTIDAD
A	BOLT/ BOULON/ TORNILLO $\Phi 5/16" * 115\text{mm}$		8 PCS
B	LOCK WASHER/ RONDELLE DE BLOCAGE/ ARANDELA DE BLOQUEO $\Phi 5/16" * 1,8\text{mm}$		8 PCS
C	FLAT WASHER/ RONDELLE PLATE/ ARANDELA PLANA $\Phi 5/16"$		8 PCS
D	WRENCH/ CLÉ/ LLAVE INGLESA		1 PC
E	LEVELER/NIVELEUR/NIVELADOR		9 PCS
F	NUT/ ÉCROU/ NUEZ $\Phi 5/16" * 16\text{mm}$		8 PCS
G	CURVED WASHER/ RONDELLE COURBÉE/ ARANDELA CURVA $\Phi 5/16"$		8 PCS
H	SCREW/VIS/TORNILLO #8*32mm		29 PCS
K	BOLT/ BOULON/ TORNILLO $\Phi 5/16" * 38\text{mm}$		8 PCS
I	BOLT/ BOULON/ TORNILLO $\Phi 1/4" * 50\text{mm}$		10 PCS
L	ALLEN WRENCH/ CLÉ ALLEN/ LLAVE ALLEN		1 PC
M	LOCK WASHER/ RONDELLE DE BLOCAGE/ ARANDELA DE BLOQUEO $\Phi 1/4" * 1,5\text{mm}$		10 PCS
N	FLAT WASHER/ RONDELLE PLATE/ ARANDELA PLANA $\Phi 1/4"$		10 PCS

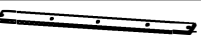
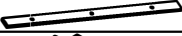
LIST OF PARTS AND HARDWARE/ LISTE DES PIÈCES ET DU MATÉRIEL/ LISTA DE PIEZAS Y HARDWARE

NO#/ NOMBRE/ NÚMERO	DESCRIPTION/ DESCRIPTION/ DESCRIPCIÓN		QUANTITY/ QUANTITÉ/ CANTIDAD
1	SLAT/ LATTE/ LISTÓN		13 PCS
2	BOTTOM SLAT/ LATTE DU BAS/ LISTÓN INFERIOR		3 PCS
3	SUPPORT LEG/JAMBE D'APPUI/ PIERNA DE APOYO 410*32*32mm		9 PCS

NOTE:
ASSEMBLE UNIT ON A SOFT SURFACE.
ASSEMBLEZ L'UNITÉ SUR UNE SURFACE MOLLE.
ENSAMBLE LA UNIDAD EN UNA SUPERFICIE PLANA Y SUAVE.
DO NOT TIGHTEN BOLTS UNTIL THE UNIT IS COMPLETELY ASSEMBLED.
NE SERREZ PAS LES BOULONS JUSQU'À CE QUE L'UNITÉ SOIT COMPLÈTEMENT ASSEMBLÉE.
NO APRIETE LOS TORNILLOS HASTA QUE LA UNIDAD ESTE COMPLETAMENTE ENSAMBLADA.

ASSEMBLY INSTRUCTIONS

INSTRUCTIONS DE MONTAGE

INSTRUCCIONES DE MONTAJE

King Upholstered Headboard

King Storage Footboard

Cal.King Panel Rails for Storage Footboard

Note:
Side rail A Mark HB or FB

Step/ Étape/ Paso 2

Step/ Étape/ Paso 5

Step/ Étape/ Paso 1

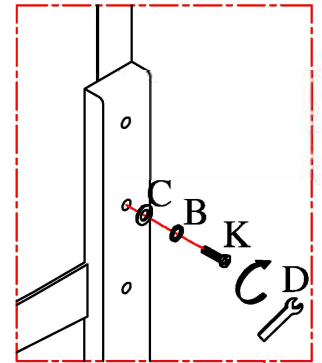
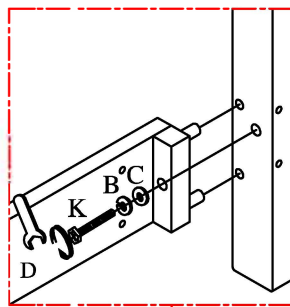
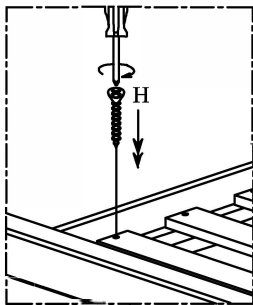

Step/ Étape/ Paso 4

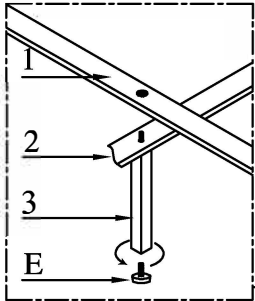

LEFT LEG

RIGHT LEG

Step/ Étape/ Paso 3

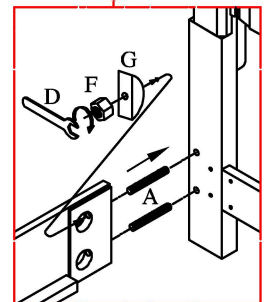

Step/ Étape/ Paso 6

