

ASSEMBLY INSTRUCTIONS

TWIN BED

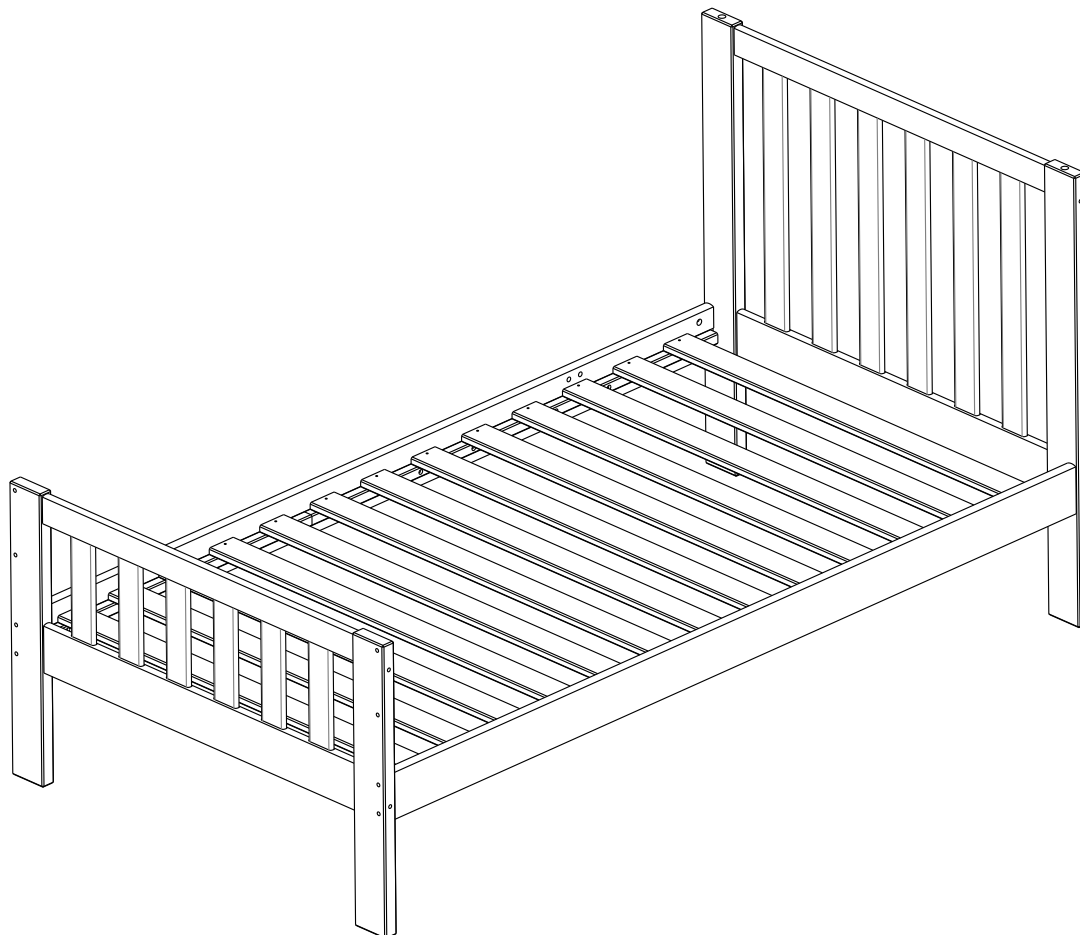

REPLACEMENT PARTS

Please do not contact the company purchased from as we can help you faster.

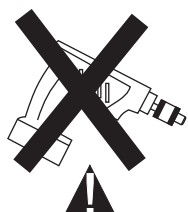

* Use of power tool to assemble this product will invalidate any claim and damage this product making it unsafe!!!
* Please assemble on a clean soft surface to avoid damage.

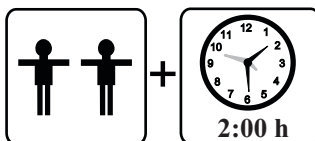

Tools Required

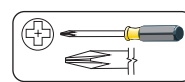

(Not included)

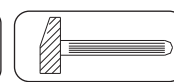

(Not included)

Part List - Twin Bed

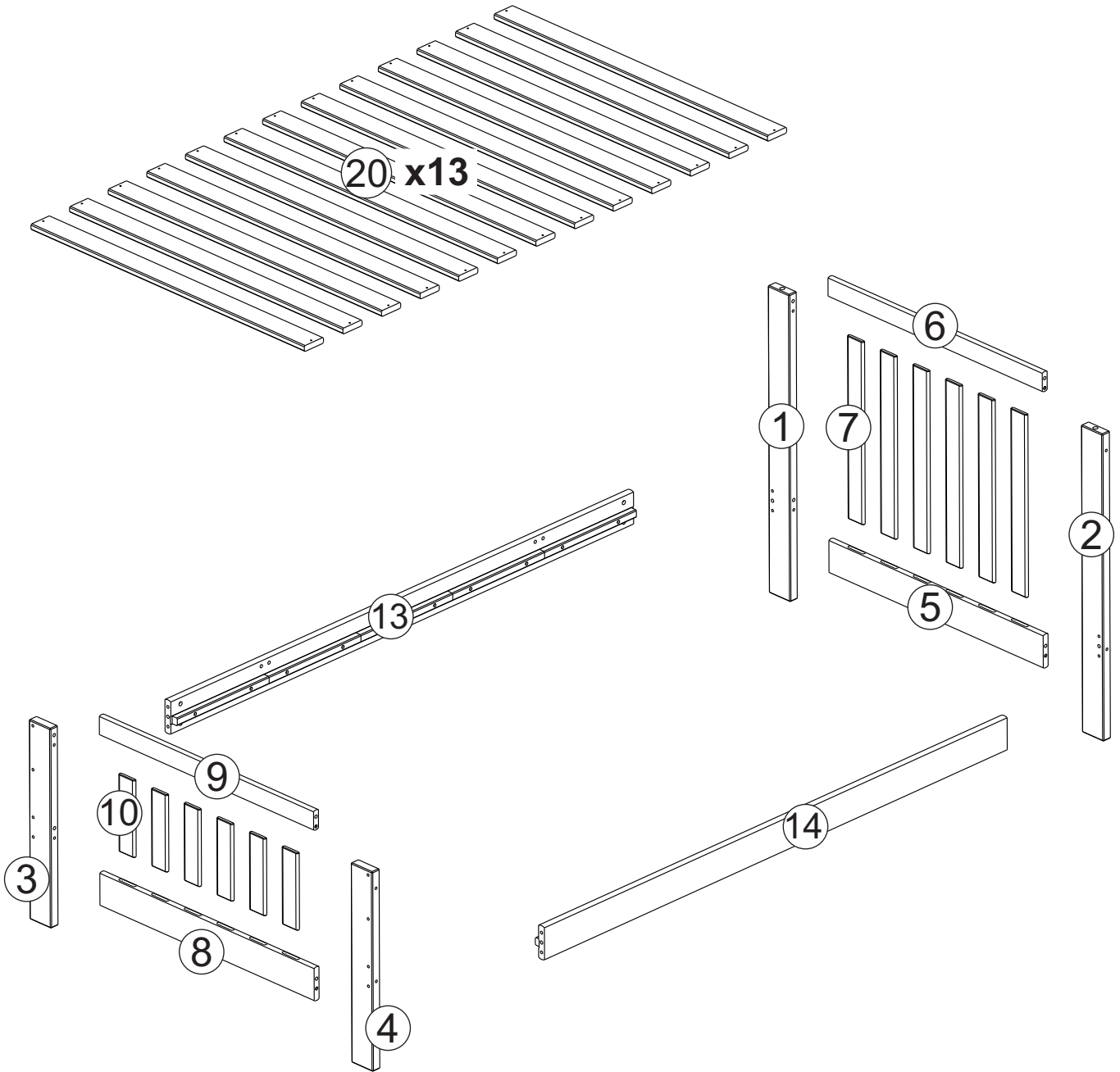

Identifying the Hardware-Identify the hardware using the illustrations below.

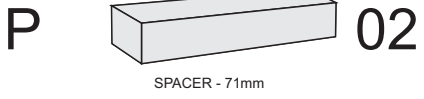
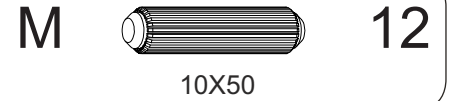
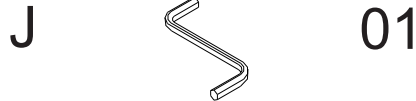
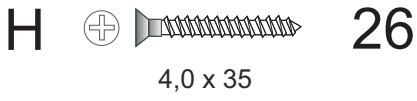
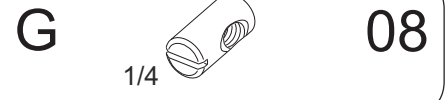
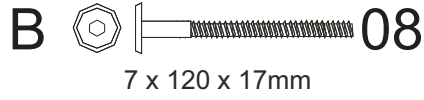
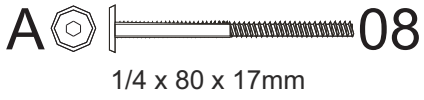

01

M

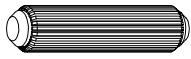

10X50

12



(Not included)

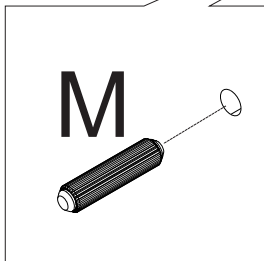
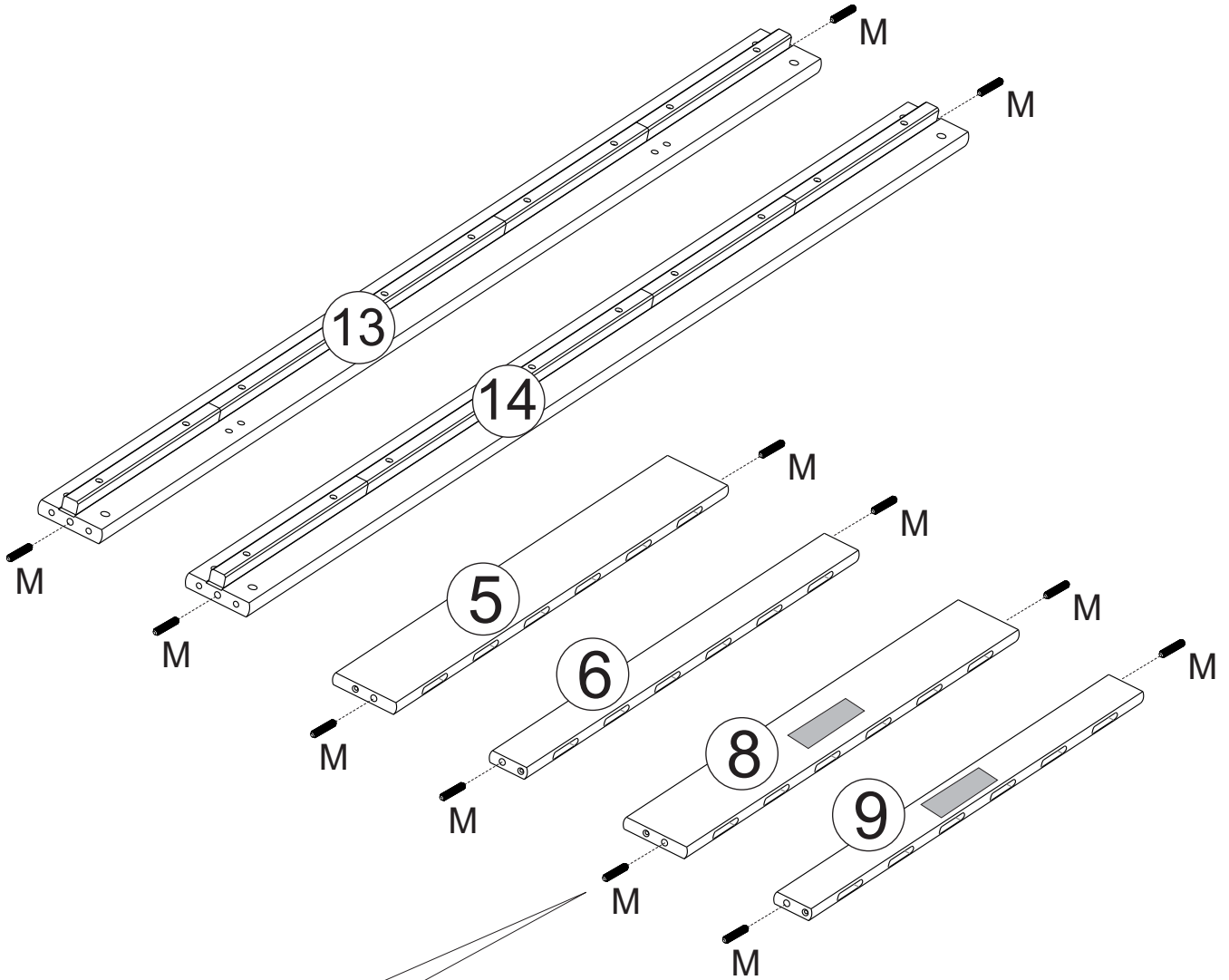

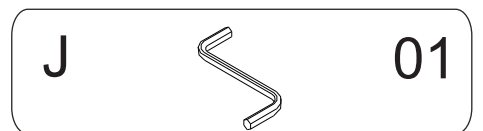
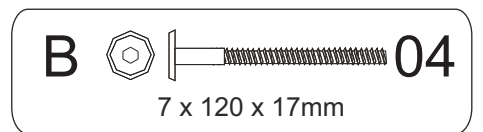
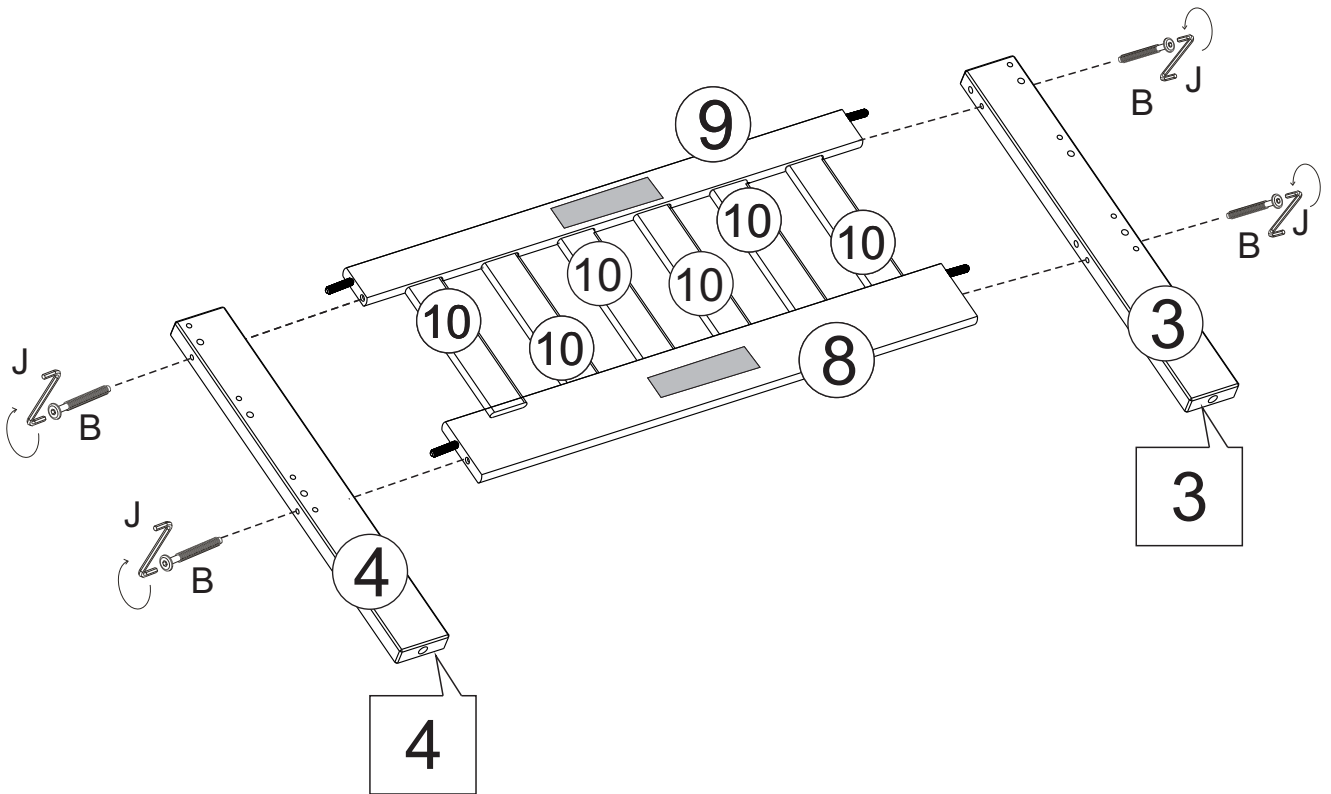
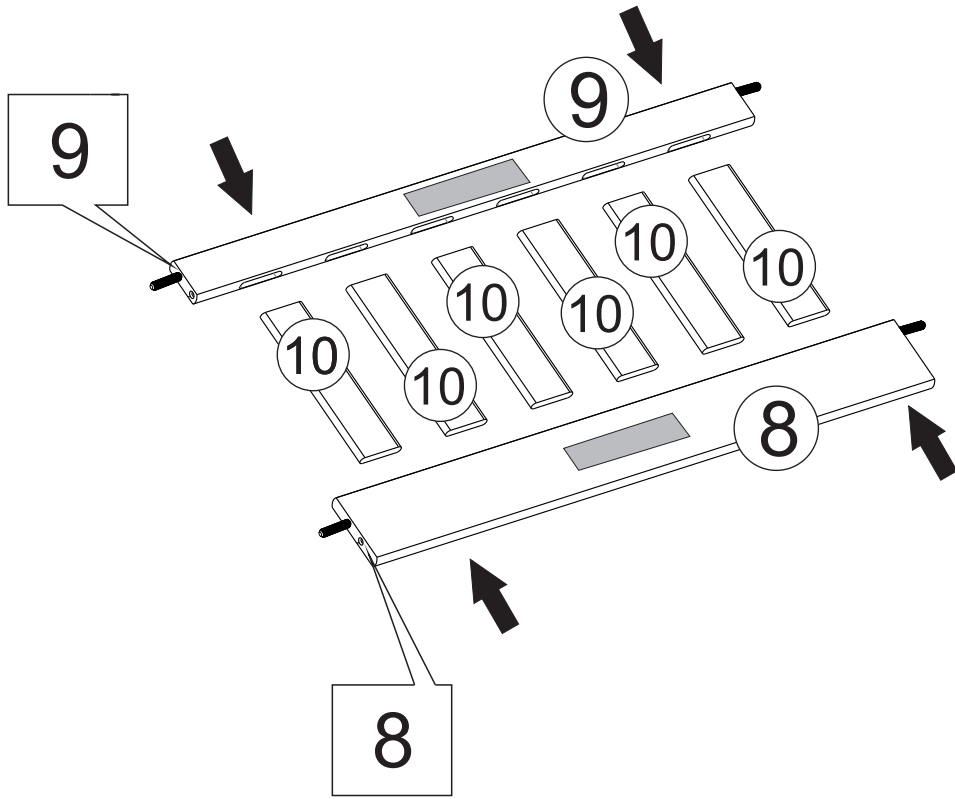

02

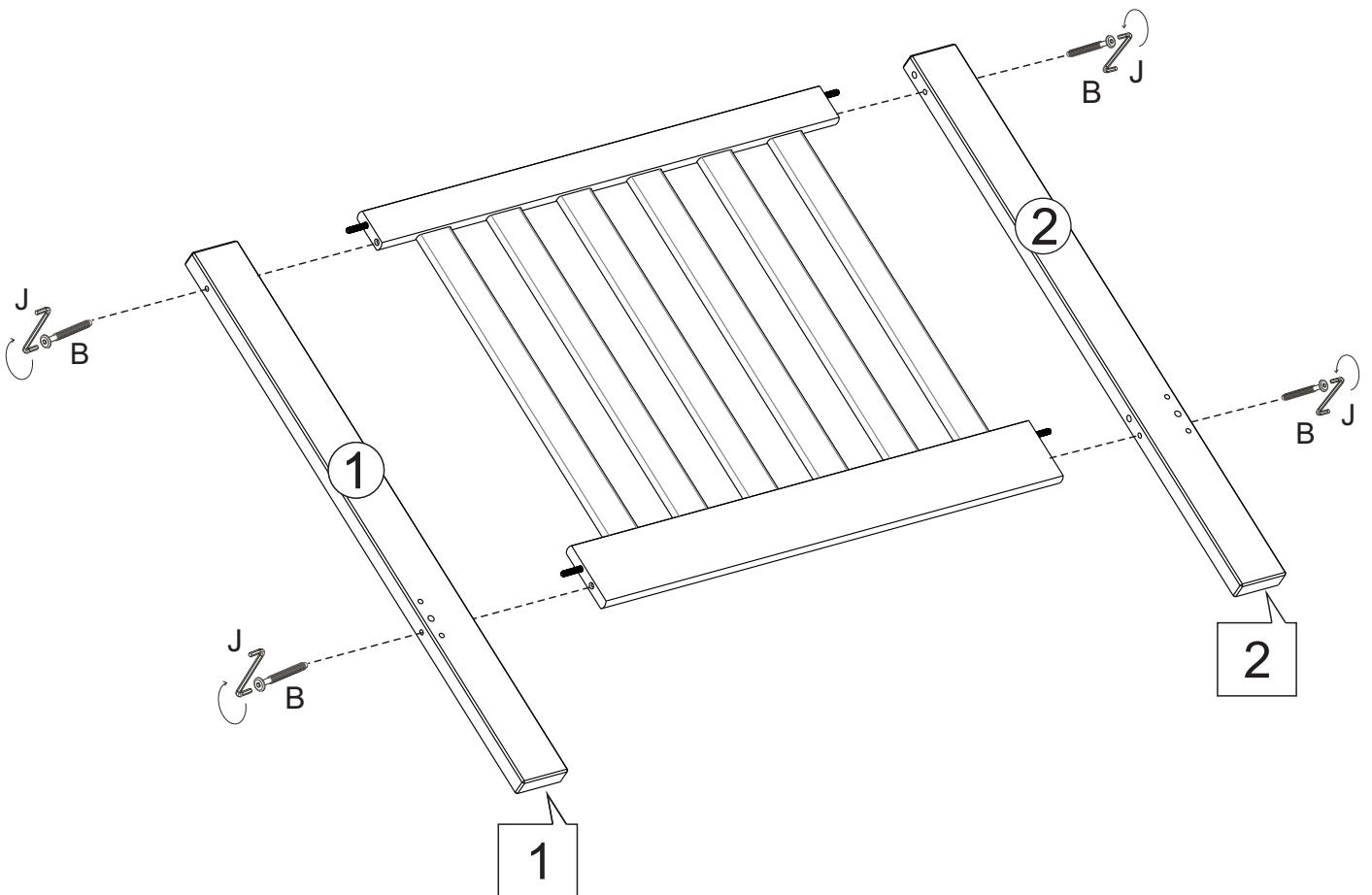
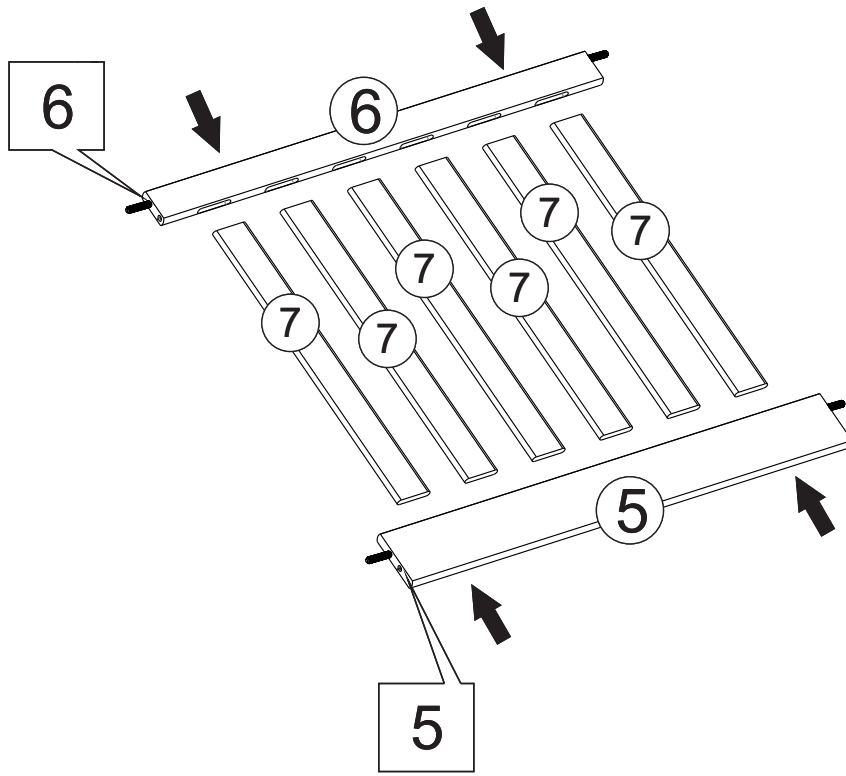

03

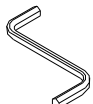

B   **04**
7 x 120 x 17mm

J  **01**

04

A  **08**
1/4 x 80 x 17mm

G  **08**
1/4

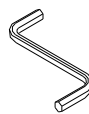
J  **01**

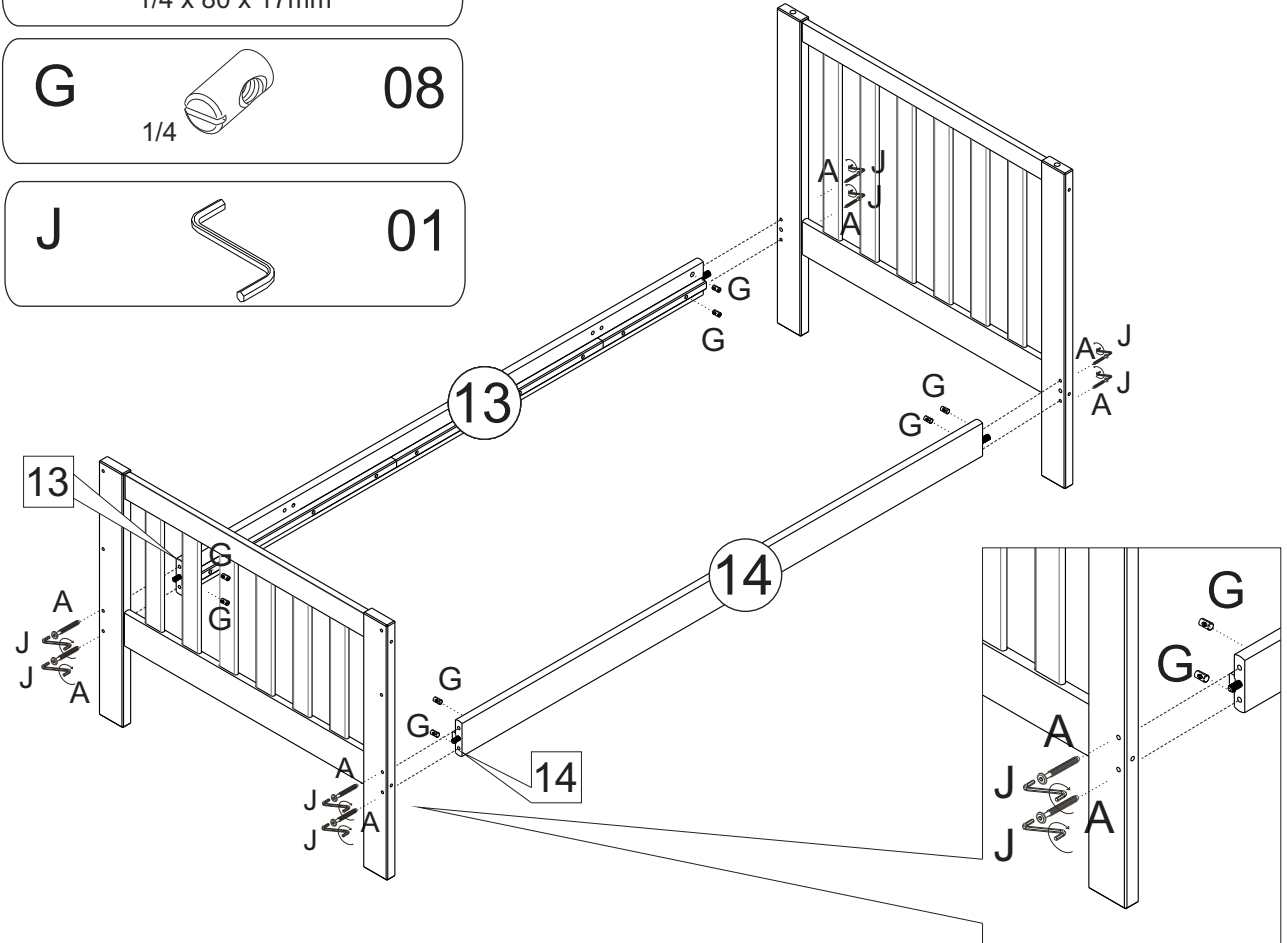

05

H  **26**
4,0 x 35

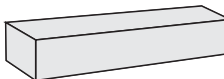
P  **02**
SPACER - 71mm

