

**03DTSHPN1006FGD2TW-V1**

**10X6 SHIPLAP PENT SUMMERHOUSE.**

**BEFORE YOU START PLEASE READ INSTRUCTIONS CAREFULLY**

- Check the pack and make sure you have all the items listed in the parts list provided.
- When you are ready to start, make sure you have the right tools at hand (not supplied - see the equipment list on next page).
- Ensure there is plenty of space and a clean dry area for assembly.
- Ensure you have enough time to build the product to ensure the building is water tight.

**LOCATION FOR YOUR GARDEN BUILDING**

A minimum of 600mm should be left around the perimeter of your garden building to allow access for maintenance, annual treatment and to allow air flow around the building.

Where possible you should avoid placing your garden building underneath large trees to prevent the tree causing damage to the building.

**TIMBER**

As with all natural materials, timber can be affected during various weather conditions. For the duration of heavy or extended periods of rain, swelling of the wood panels may occur. Warping of the wood may also occur during excessive dry spells due to an interior moisture loss. Unfortunately, these processes cannot be avoided but can be helped. It is suggested that the outdoor building is sprayed with water during extended periods of warm sunshine and sheltered as much as possible during rain or snow.

Once your garden building has been installed it will need to be treated within 14 days (weather permitting) and annually to prevent the timber from deteriorating and to waterproof it. This is required to maintain the anti-rot guarantee.

Dip Treated buildings - Require a preservative treatment to protect against rot and decay and a waterproof treatment to prevent water ingress

Pressure Treated buildings - Require a waterproof treatment to prevent water ingress

Log Cabins/Insulated Garden Rooms - Are supplied untreated and require a preservative and waterproofing treatment.

**BUILDING A BASE**

When thinking about where the building and where the base is going to be constructed: Ensure that there will be access to all sides for maintenance work and annual treatment.

Ensure the base is level and is built on firm ground, to prevent distortion. Refer to diagrams for the base dimensions, The base should be slightly smaller than the external measurement of the building, i.e. The cladding should overlap the base, creating a run off for water. It is also recommended that the floor be at least 25mm above the surrounding ground level to avoid flooding.

**TYPES OF BASE**

- Concrete 75mm laid on top of 75mm hard-core.
- Slabs laid on 50mm of sharp sand.
- Wooden base.

Whilst all products manufactured are made to the highest standards of safety and in the case of children's products independently tested to EN71 level, we cannot accept responsibility for your safety whilst erecting or using this product.



x2

All buildings should be erected by two adults



Winter = High Moisture = Expansion  
Summer = Low Moisture = Contraction



**2mm Drill bit**

For ease of assembly, you **MUST** pilot drill all screw holes and ensure all screw heads are countersunk.



**CAUTION**

Every effort has been made during the manufacturing process to eliminate the prospect of splinters on rough surfaces of the timber. You are strongly advised to wear gloves when working with or handling rough sawn timber.



For ease of assembly, you will need a tape measure to check dimensions of components.

**Screws & Nails**



Measure overall length

**Bolts**

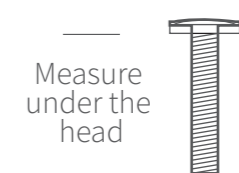

Measure under the head

To identify the fixings required for each step use a measuring tape.

**\*\*Protim Aquatan T5 (621)\*\***

Your building has been dip treated with Aquatan.

Aquatan is a water-based concentrate which is diluted with water, the building as been treated by the correct application of Aquatan solution and then allowed to dry.

Aquatan is a decorative finish to colour the wood, which is applied industrially to timber fence panels and garden buildings.

Aquatan undiluted contains: boric acid, sodium hydroxide 32% solution, aqueous mixture of sodium dioctyl sulphosuccinat and alcohols: 2, 4, 6-trichlorophenol.



REGISTER FOR YOUR

# ANTI-ROT

GUARANTEE TODAY

PLEASE SCAN HERE:



In all instances for assistance with your product, please contact customer care on :  
01636 821215 or [customerservice@merciagp.co.uk](mailto:customerservice@merciagp.co.uk)

Mercia Garden Products Limited,  
Sutton On Trent,  
Newark,  
Nottinghamshire,  
NG23 6QN

## TO DO LIST

- Find a suitable location to build *(see front cover for further information).*
- Build a base *(see front cover for further information).*
- Check the base is flat, level, clear of debris and has 60cm clearance on all sides.
- Check you have the required equipment.
- Check you have all the product items listed *(if you have missing or damaged parts please contact the customer services department, see front cover for contact details).*
- Install the product as per the step by step instructions within this pack.
- Prepare the product ready for treatment.
- Apply a preserving and a waterproofing treatment within 14 days *(weather permitting)* of installation *(pressure treated products do not require a preserver).*
- Register for your anti rot guarantee *(scan the QR below).*
- Tidy the build area and dispose of any remaining parts responsibly.
- Maintain your building *(see the manufacturers recommendations at the back of this pack).*

## EQUIPMENT LIST

- Hammer
- Flat Head Screwdriver
- Drill
- Drill Bit Set
- Phillips and Slotted Bit Sets
- Tape Measure
- Hand Saw
- Spirit Level
- Ladders/Steps
- Stanley Knife/Cutting Tool
- Sand Paper
- Gloves
- Silicone (For Windows Only)
- Wood Filler (Optional)
- Timber Preservative Treatment *(not pressure treated products)*
- Timber Water Proofing Treatment
- Treatment Mixing Stick
- Paint Brush/Sprayer/Roller

## NEED EXTRA SUPPORT

If you are unsure that your base preparation will be suitable, please contact us on 01636 821215 to discuss this further.

Alternatively, you can visit our website or MGP Logistics Online Portal for some further shededucation.

### Website:

<https://www.merciagardenproducts.co.uk/sheducation>

### MGP Logistics Online Portal:

<https://www.mgplogistics.co.uk/>

Here you will find plenty of useful information that'll help with most pre-installation and maintenance queries.



**ANY QUESTIONS?**  
CONTACT US ON  
01636 821215

## NOTES

Before assembly please make sure you have a suitable base ready to erect your building

**MADE IN GREAT BRITAIN**

**Overall Dimensions:** Width = 3028mm  
Depth = 2343mm  
Height = 2170mm

**Base Dimensions:** Width = 2912mm  
Depth = 1753mm

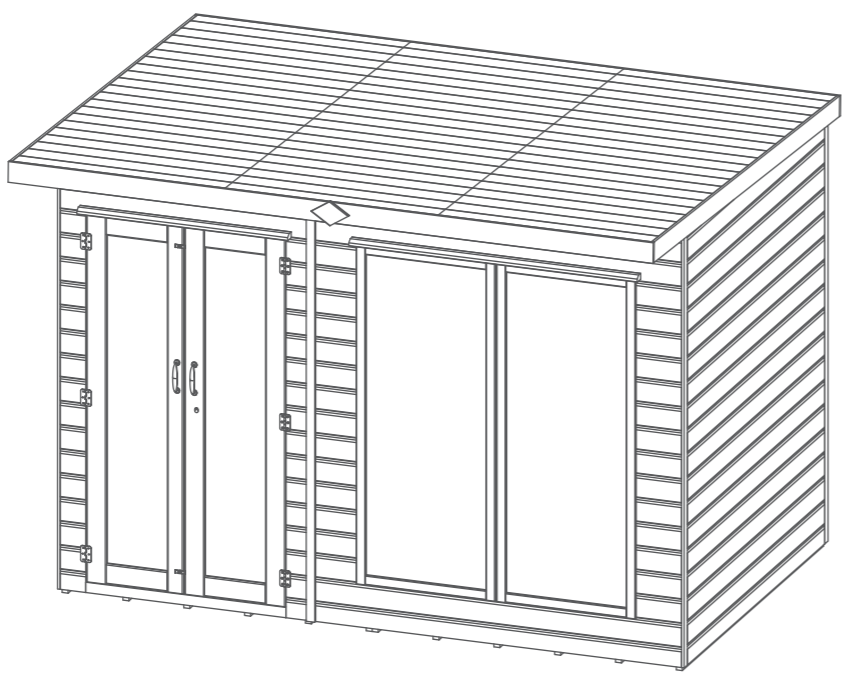



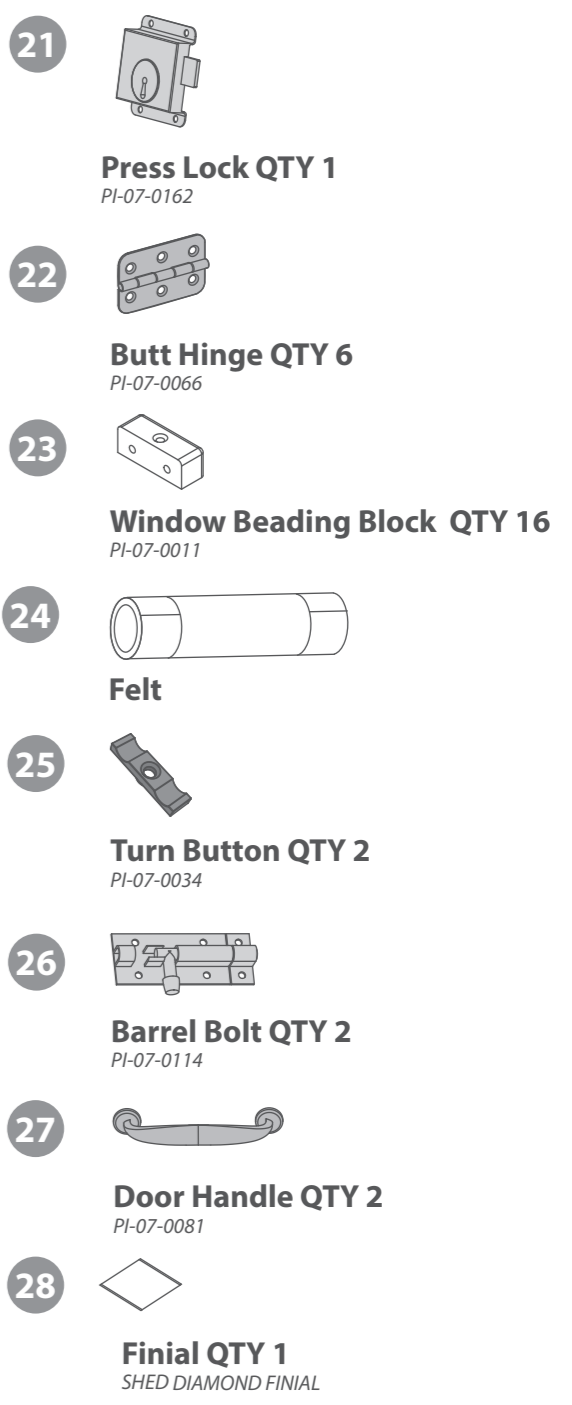
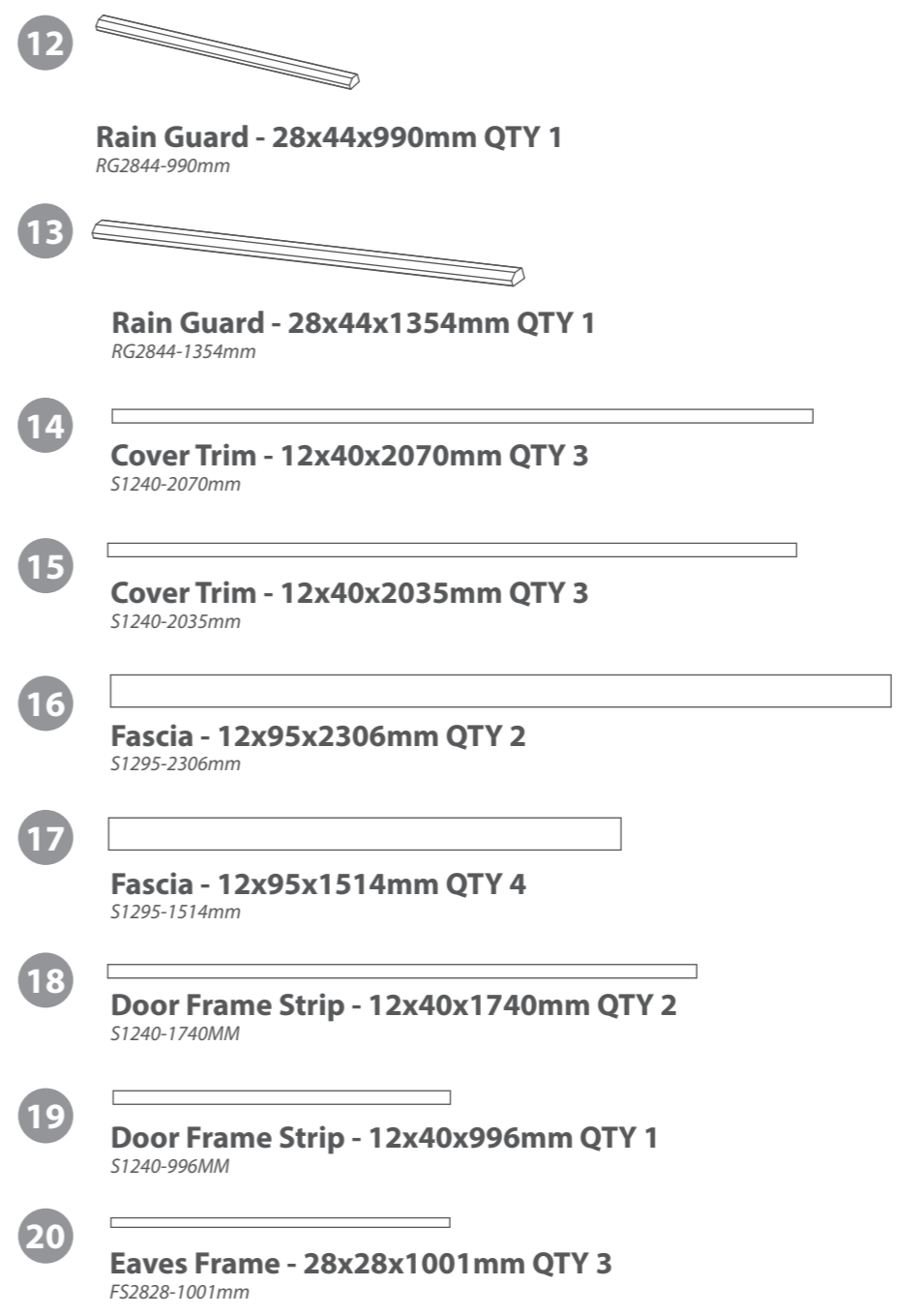
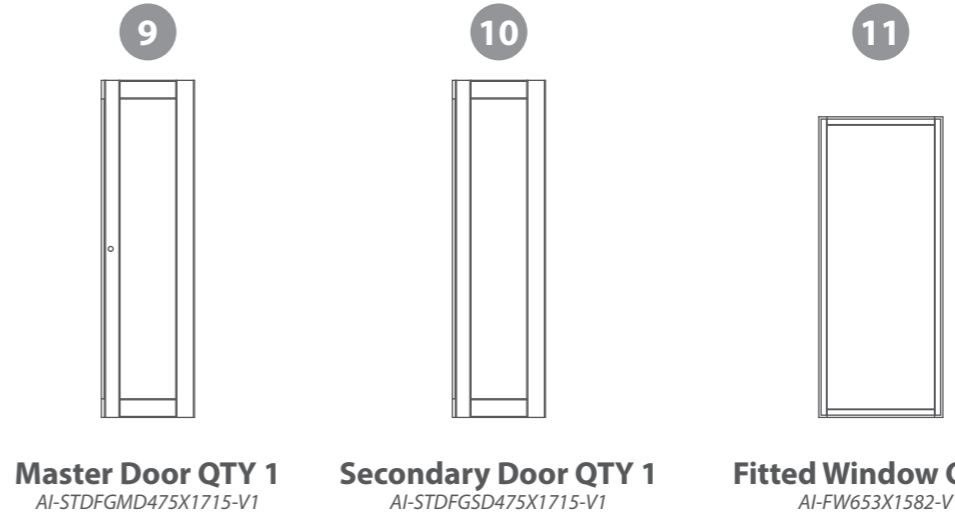
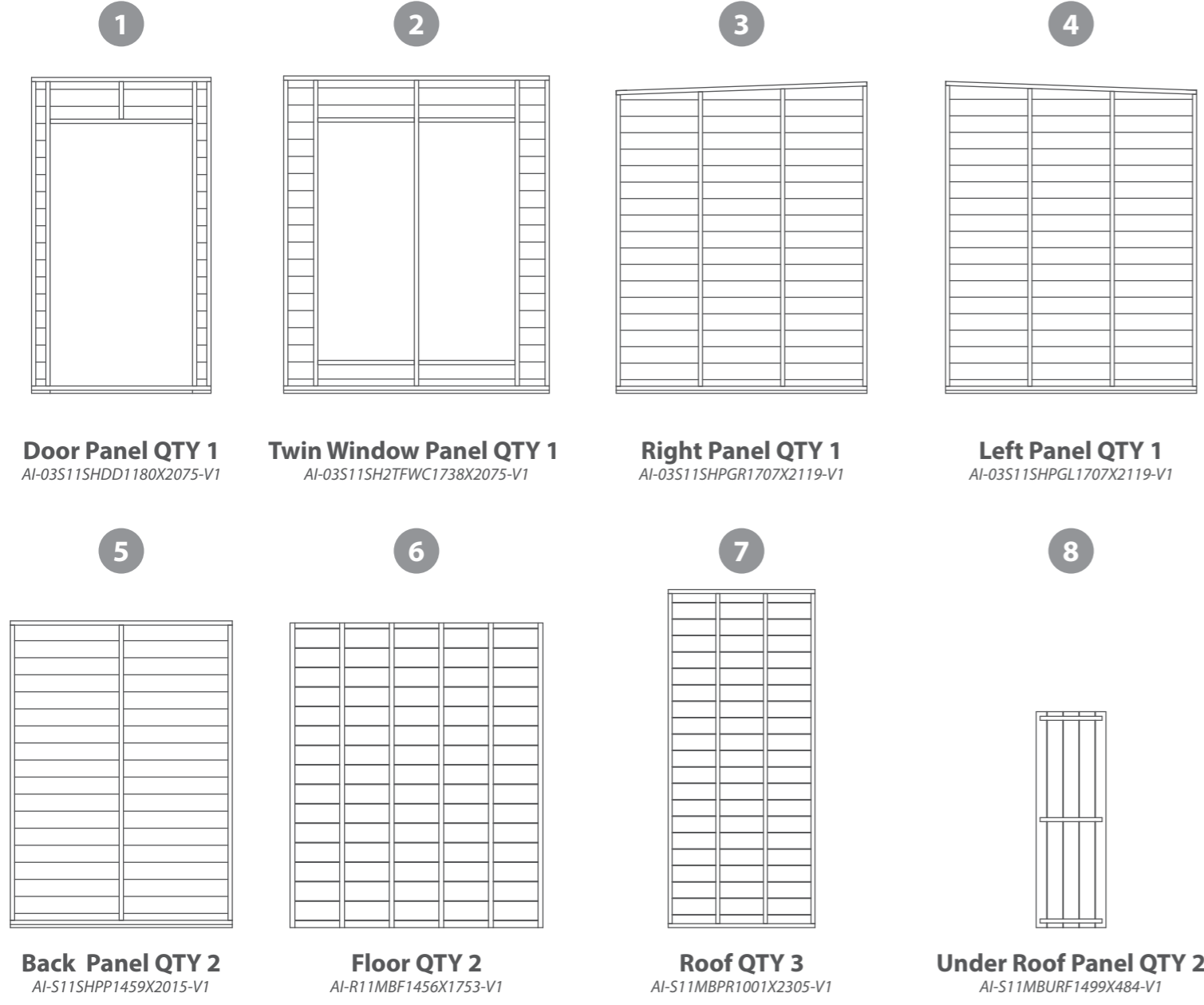



**Contents:**



# Nail Bag

There may be extra screws present in the nail bag

- |  |                           |   |                           |
|--|---------------------------|---|---------------------------|
|  | <b>50mm Screw QTY 108</b> |  | <b>25mm Screw QTY 22</b>  |
|  | <b>40mm Screw QTY 18</b>  |  | <b>10mm Screw QTY 12</b>  |
|  | <b>35mm Bolt QTY 4</b>    |  | <b>Felt Tacks QTY 125</b> |
|  | <b>30mm Screw QTY 130</b> |   |                           |

## Pre Assembly

Before assembling remove the transportation blocks from the bottom of each panel.

Take care removing the blocks as to not damage the panels. Tap with a flat headed screwdriver and hammer.

Dispose of the blocks once removed.

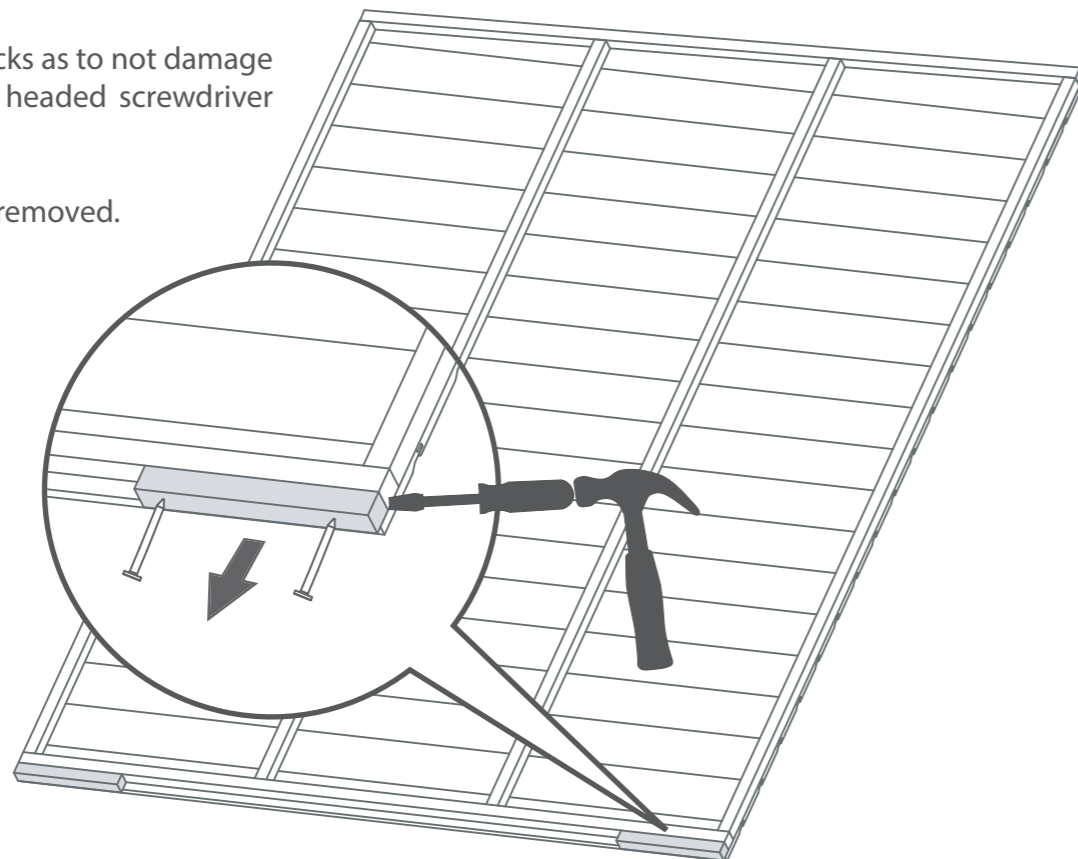

## Step 1

- Parts needed - No. 1 QTY 1**  
 - **No. 9 QTY 1**  
 - **No. 10 QTY 1**  
 - **No. 22 QTY 6**  
 - **No. 27 QTY 2**

- a** Locate the Master Door (**No.9**) and the Secondary Door (**No.10**) into the Door Panel (**No.1**) so there is equal spacing on each side, ensuring the doors interlock as shown.
- b** Locate the hinges to the Master (**No. 9**) and Secondary (**No. 10**) doors and to the door panel (**No. 1**) using 3 butt hinges (**No. 22**) per door.
- Fix the hinges to the doors using 3x25mm screws and to the Door panel using 3x30mm screws per hinge, ensure the doors open and close freely.
- c** Fix the door handles (**No. 27**) to the outside of the master and secondary door using the 35mm bolts provided.

- 4x35mm Bolts**  
**18x25mm Screws**  
**18x30mm Screws**

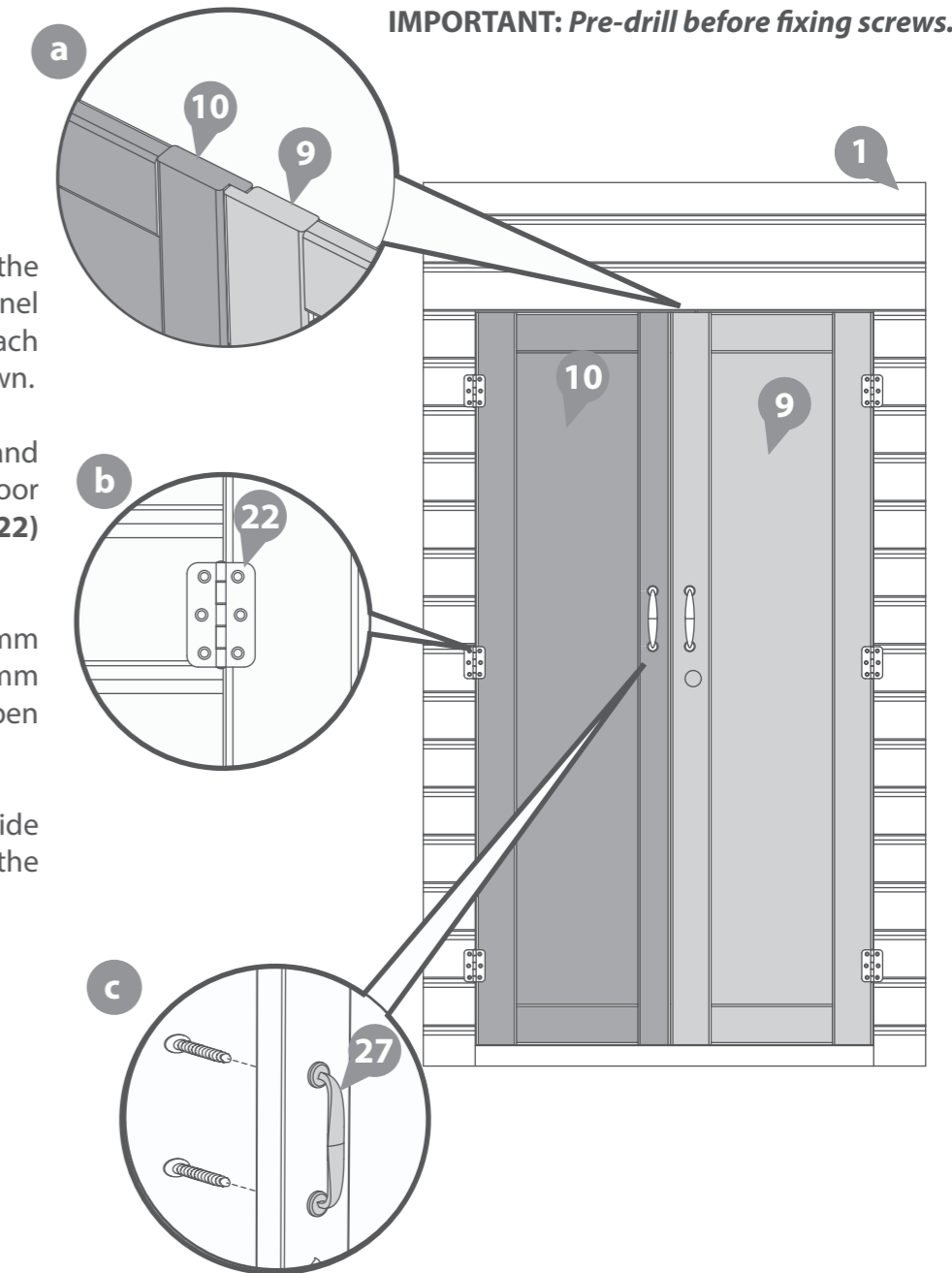

## Step 2

Parts needed - No. 21 QTY 1  
- No. 26 QTY 2

Secure the barrel bolts (No. 26) to the top & bottom of the secondary door using 6x10mm screws. Pre-drill the holes beforehand. Drill a hole in the framing above and below the door for the barrel bolt to fix into.

Attach the press lock (No. 21) to the master door with 4x25mm screws, aligning the barrel with the key hole.

*\*Ensure the key turns and locks properly before fixing to the door.*

12x10mm Screws  
4x25mm Screws

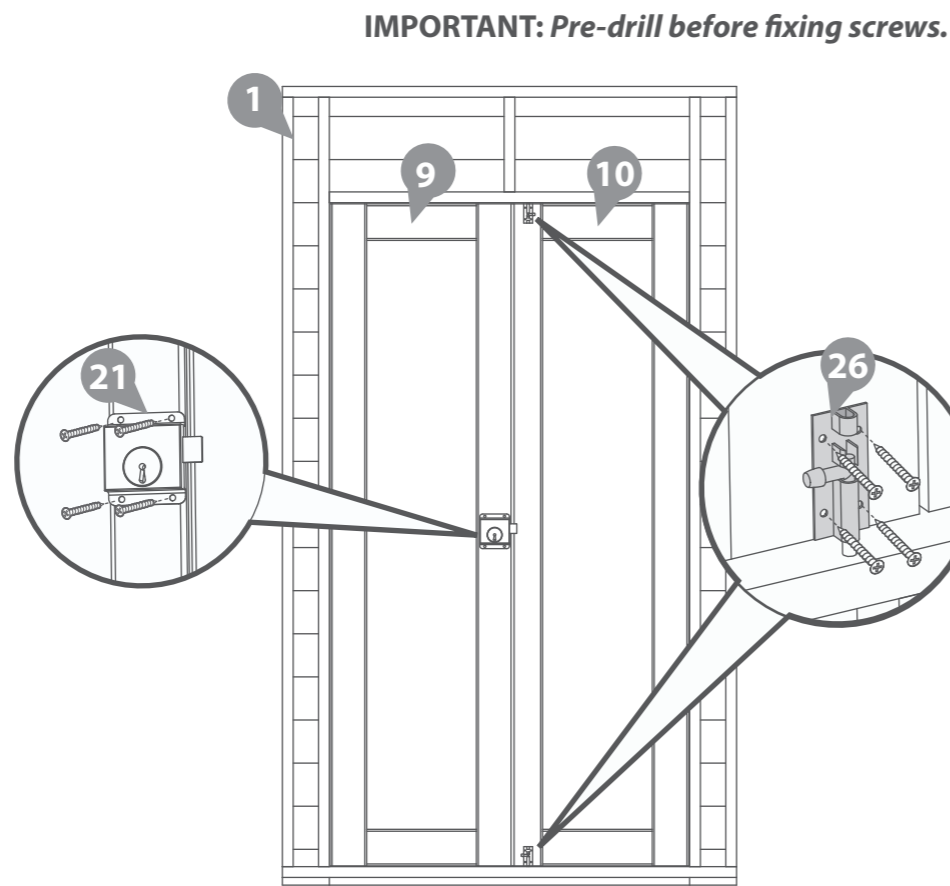

## Step 4

Parts needed - No. 4 QTY 1  
- No. 5 QTY 1

Locate the Left Panel (No. 4) and the Back Panel (No. 5) on top of the Floor as shown.

*\*Please note that the back panels are shorter than the side panel.*

Fix the panels together at the corners using 4x50mm screws, as shown in the illustration.

Do **not** secure the building to the floor until the roof is fitted.

4x50mm Screws

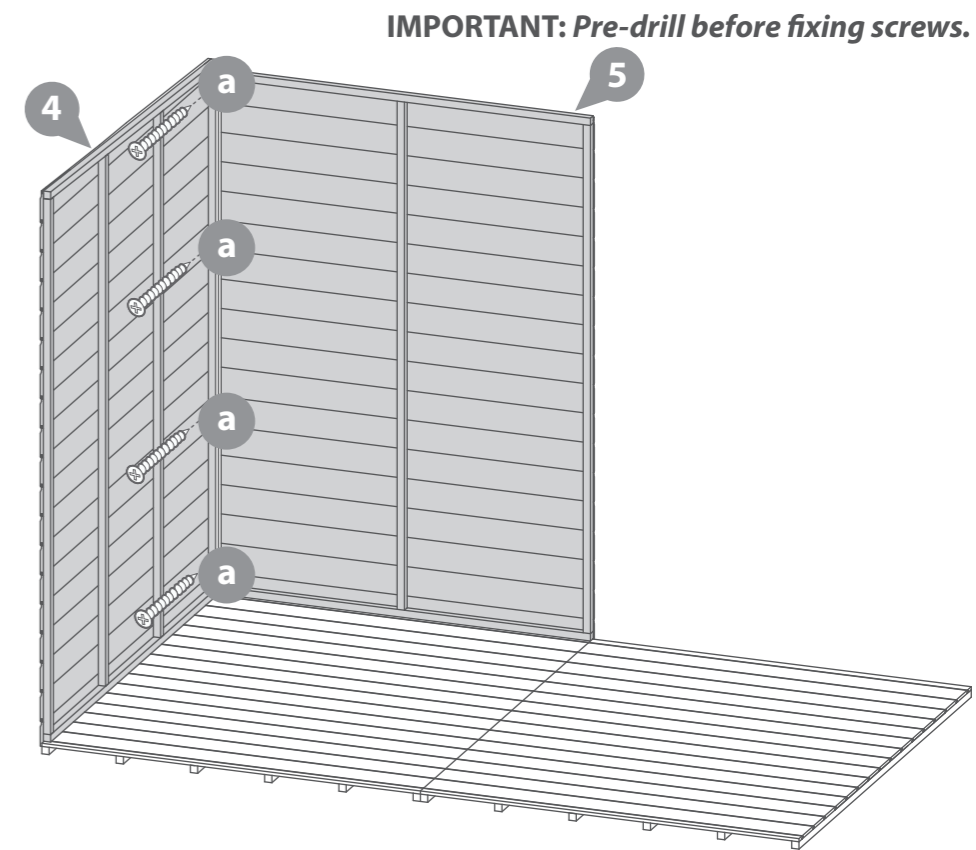
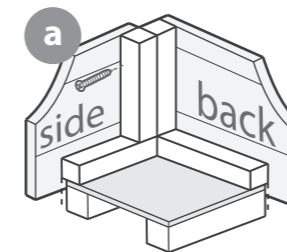
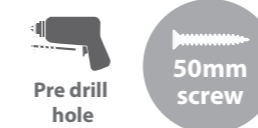

## Step 3

Parts needed - No. 6 QTY 2

Place the assembled floor panels (No. 6) upside down onto a firm and level base. Ensure the base has suitable drainage, free from areas where standing water can collect.

Secure the floors together using 10x50mm screws through the floor bearers in an alternating pattern.

Once fixed together turn the floor back the right way up.

10x50mm Screws



## Step 5

Parts needed - No. 3 QTY 1  
- No. 5 QTY 1

Locate the Back Panel (No. 5) on top of the Floor next to the already standing Back Panel. Secure the back panels together using 4x50mm screws.

Locate the Right Panel (No. 3) on top of the floor as shown.

*\*Please note that the back panels are shorter than the side panel.*

Fix the Back and Right Panels together at the corners using 4x50mm screws, as shown in the illustration.

Do **not** secure the building to the floor until the roof is fitted.

8x50mm Screws

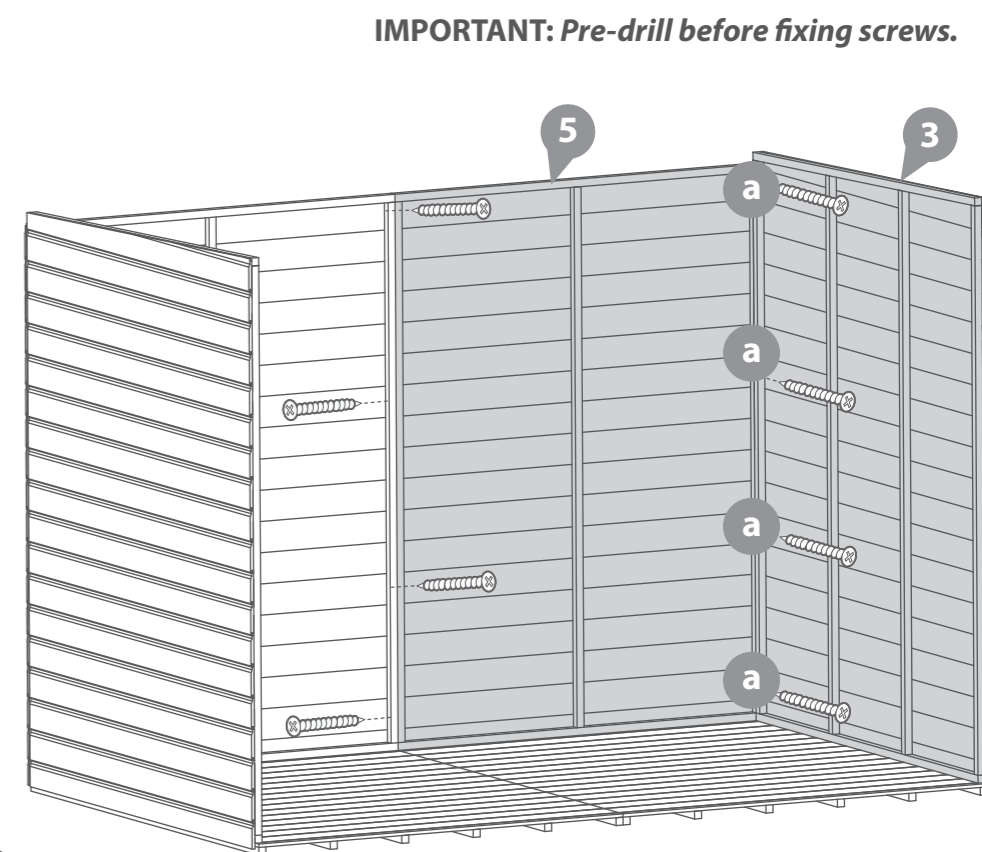
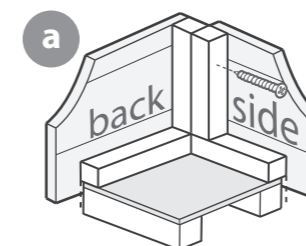

## Step 6

Parts needed - No. 2 QTY 1

Locate the Twin Window Panel (No. 2) on top of the Floor at the front of the building, as shown.

*\*Please note that the single window panel is shorter than the side panels.*

Fix the Panels together at the corners using 4x50mm screws, as shown in the illustration.

Do **not** secure the building to the floor until the roof is fitted.

4x50mm Screws

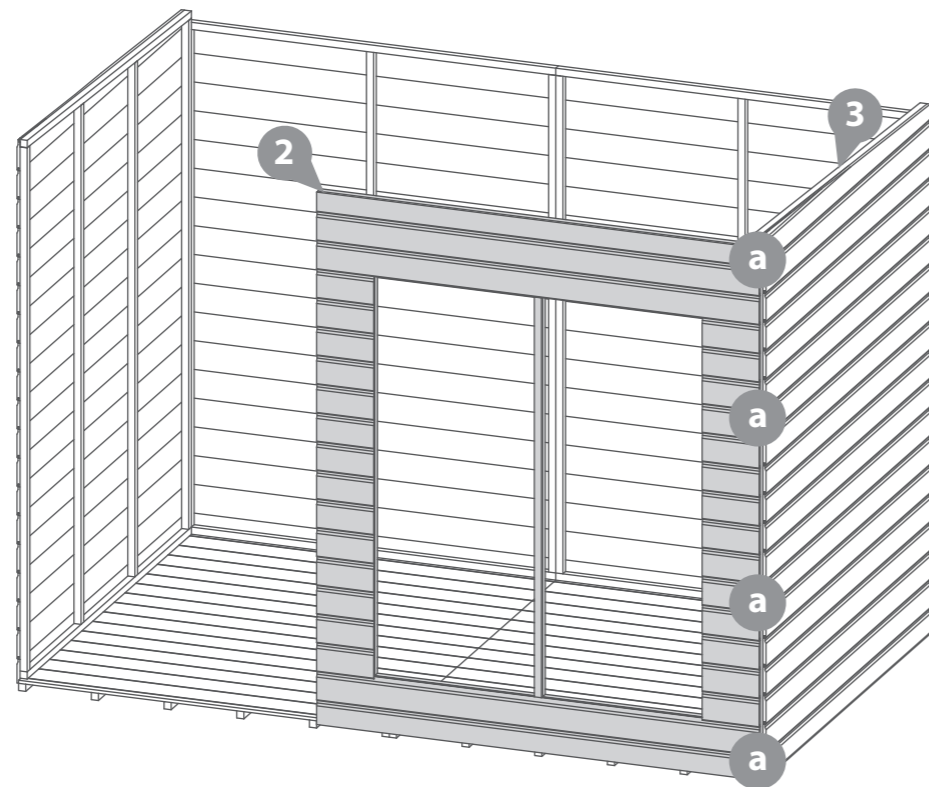
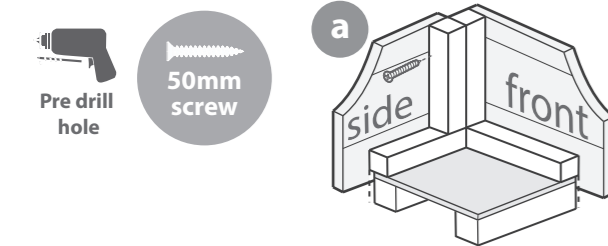

**IMPORTANT: Pre-drill before fixing screws.**

## Step 8

Parts needed - No. 7 QTY 3  
- No. 20 QTY 3

Fix the Eaves framing (No.20) to the roof (No.7) using 4x50mm screws per eaves framing, screwing through the eaves framing and into the roof framing.

Ensure the eaves framing is flush to the edges of the roof framing before securing

12x50mm Screws

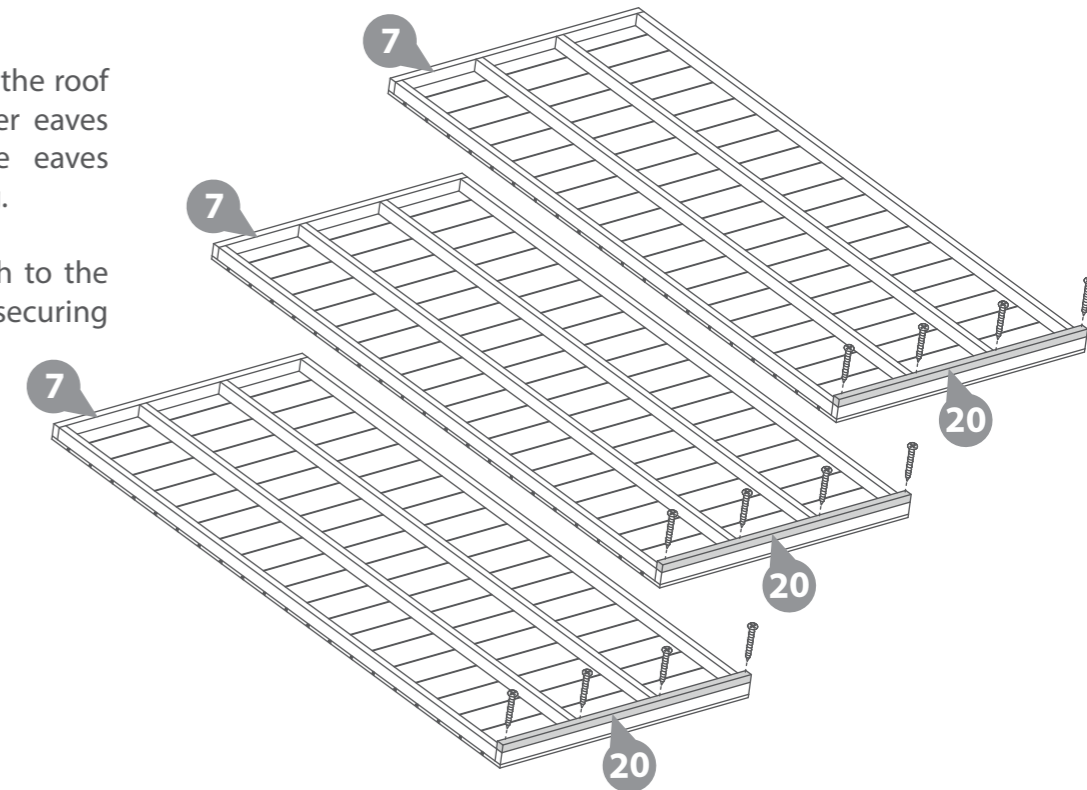

## Step 7

Parts needed - No. 1 QTY 1

Locate the Door Panel (No. 1) on top of the Floor between the Single Window Panel (No. 2) and the Left Panel (No. 4), as shown.

*\*Please note that the Door panel is shorter than the side panels.*

Fix the Panels together using 4x50mm screws, as shown in the illustration.

Do **not** secure the building to the floor until the roof is fitted.

8x50mm Screws

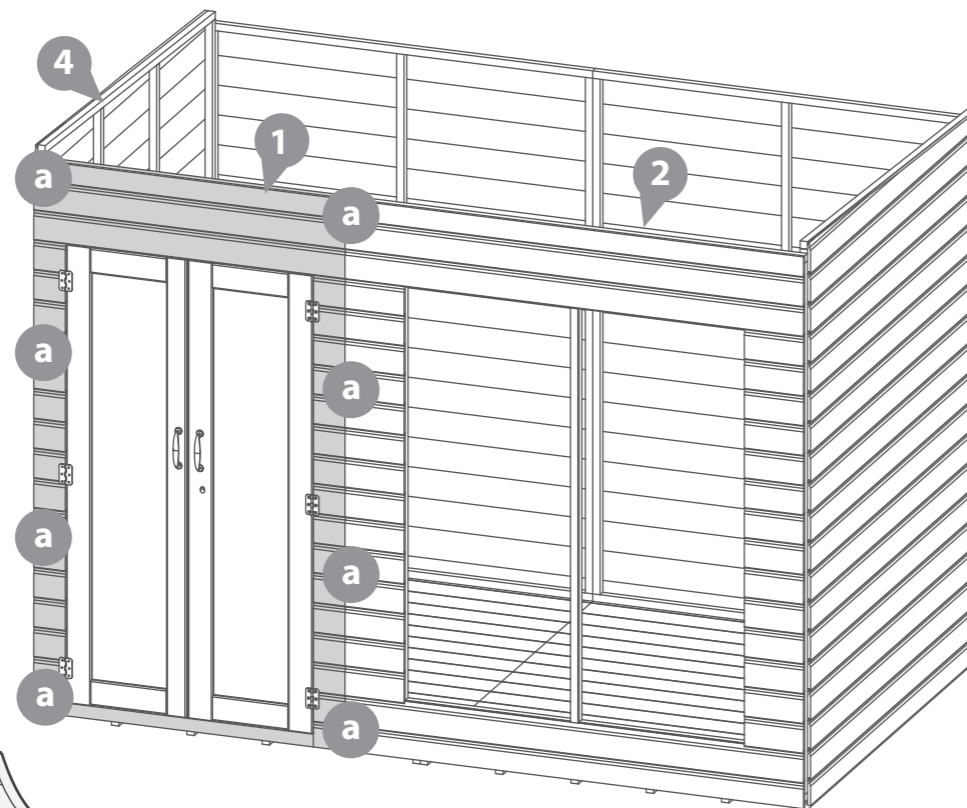
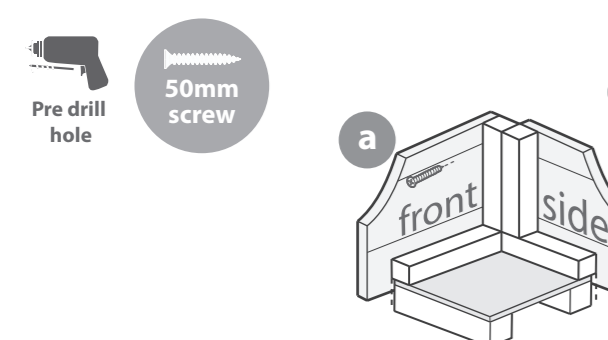

**IMPORTANT: Pre-drill before fixing screws.**

## Step 9

Parts needed - No. 7 QTY 3

Place the Roof Panels (No. 7) onto the top of the building.

Align the three Roof Panels so they sit square, ensuring the eaves frames (No.20) sit at the back of the building.

**\*The roof panels should sit on top of the left and right panels, the roof panels framing should sit on top of the back, door and twin window panels.\***

**Do not secure the building to the Floor until the roof is fitted.**

**IMPORTANT: Pre-drill before fixing screws.**

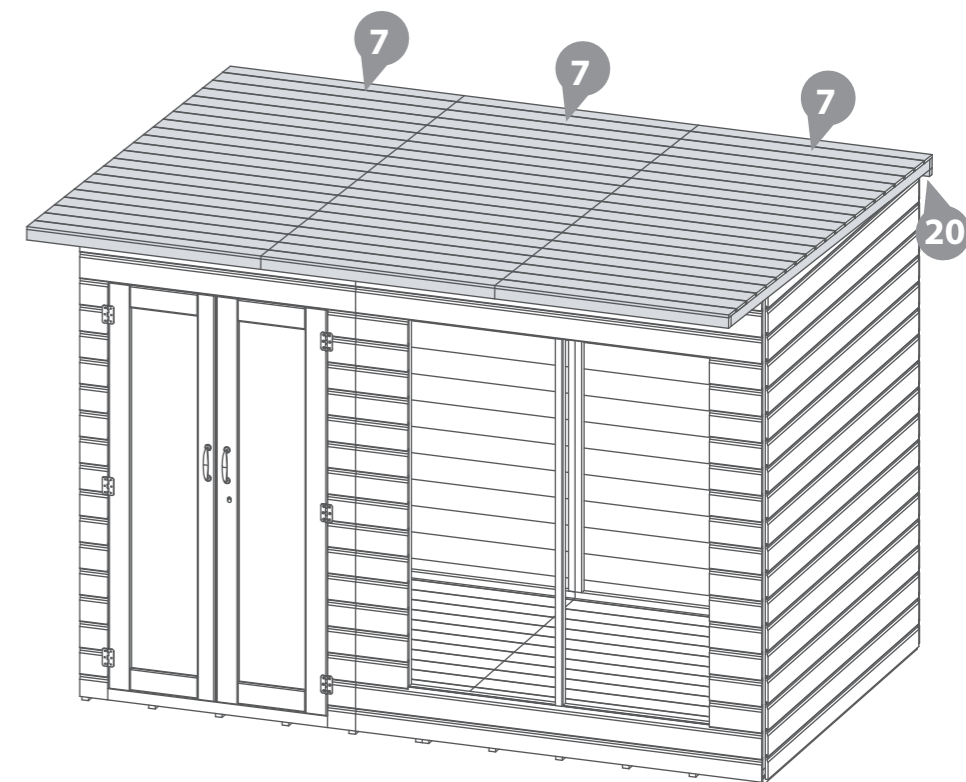

## Step 10

Fix the three Roof Panels (**No. 7**) together using 50mm screws. Offset the screws from each other as shown in the diagram.

**\*Roof boards not shown for illustration purposes.**

**Do not secure the building to the Floor until the roof is fitted.**

### 16x50mm Screws

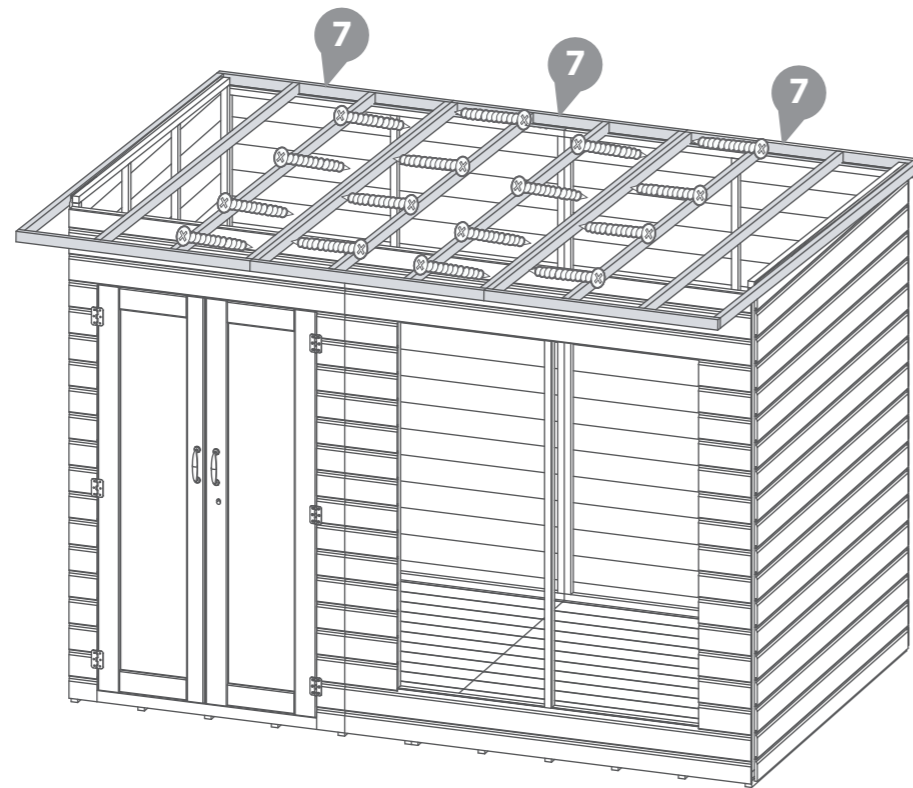

## IMPORTANT: Pre-drill before fixing screws. Step 12

Once the Roof is aligned and secure the Floor can be fixed into position.

Fix the building into place by screwing through the panel into the floor making sure to screw into the floor bearers.

### 20x50mm Screws

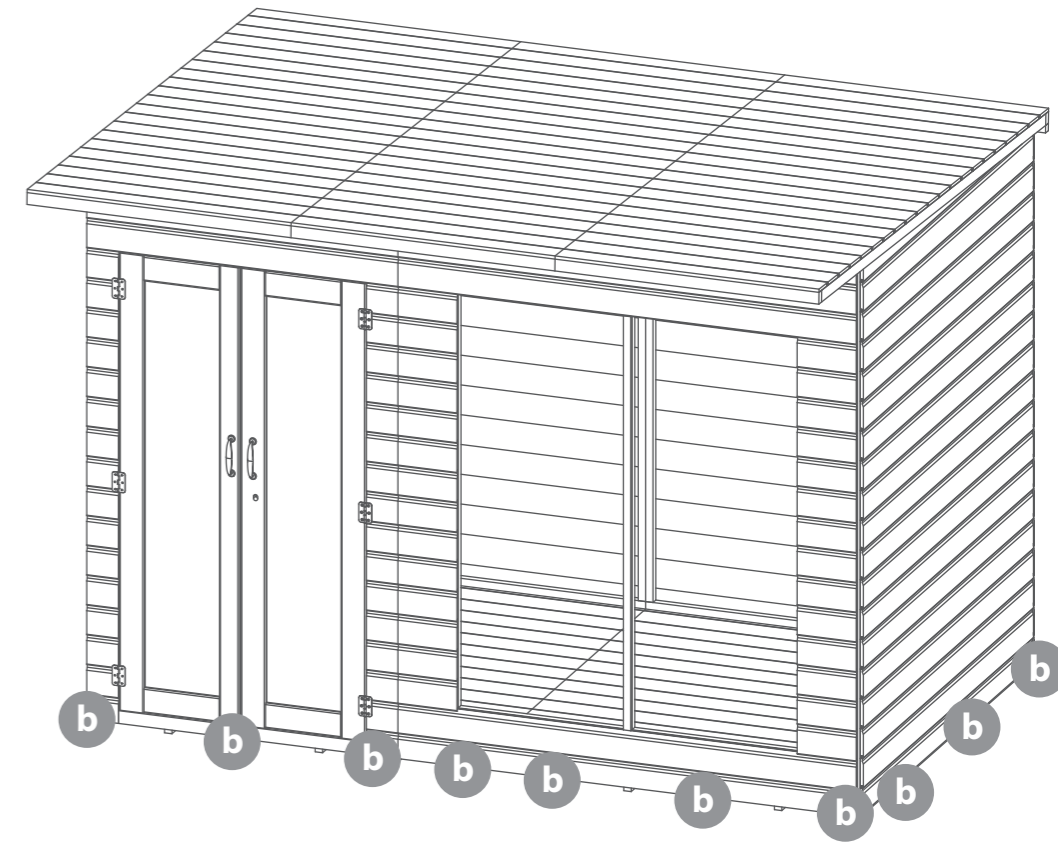
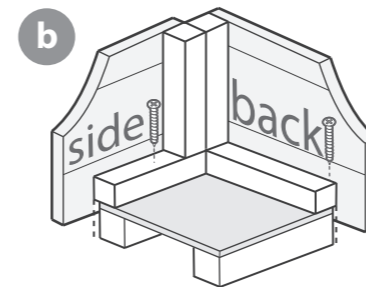

## IMPORTANT: Pre-drill before fixing screws.

## Step 11

Internally, secure the roof panels at the front and back of the building using 10x50mm screws.

Screw up through the panel framing into the framing of the Roof Panel.

**\*Roof boards not shown for illustrative purposes.**

**Do not secure the building to the Floor until the roof is fitted.**

### 20x50mm Screws

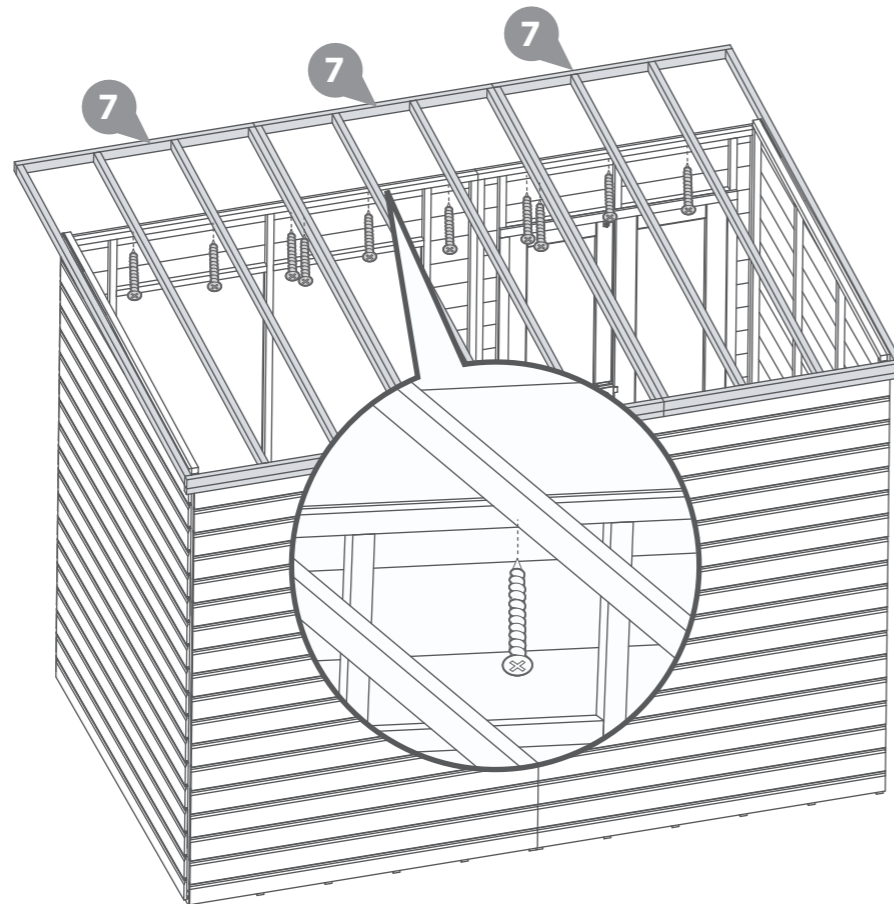

## IMPORTANT: Pre-drill before fixing screws. Step 13

### Parts needed - No. 8 QTY 2

Place the Under Roof Panel (**No. 8**) into position on the underside of the Roof overhang, as shown. Ensure that it is flush to the front and sides of the building.

Using a pencil, mark on the under roof panel where the roof panel framing is to use as a guide for fixing into place.

Fix the Under Roof Panel (**No. 8**) in place using 3x30mm screws per Roof frame, as shown. Make sure to screw up through the cladding, in to the Roof framing.

### 30x30mm Screws

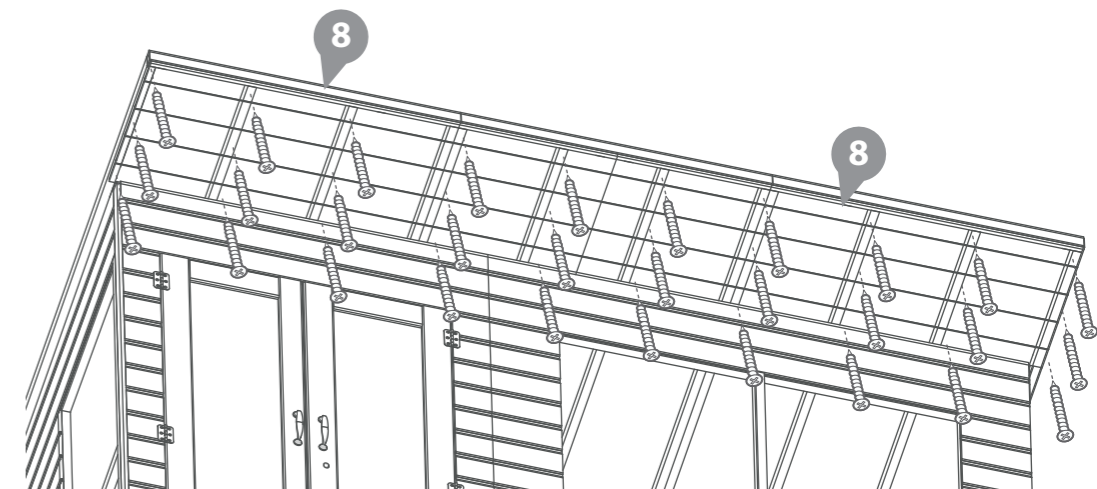

## IMPORTANT: Pre-drill before fixing screws.

## Step 14

Parts needed - No. 24 QTY 1

Cut the Felt (No. 24) into 3 sheets measuring **3110mm (L) x 1000mm (W)**.

Lay the sheets onto the roof in the order shown in the diagram, starting at the back and working towards the front.

**\*Ensure there is approximately 50mm of overhang around the building.**

Fix into place using felt tacks at 100mm intervals.

125 x Felt tacks



**IMPORTANT: Pre-drill before fixing screws.**

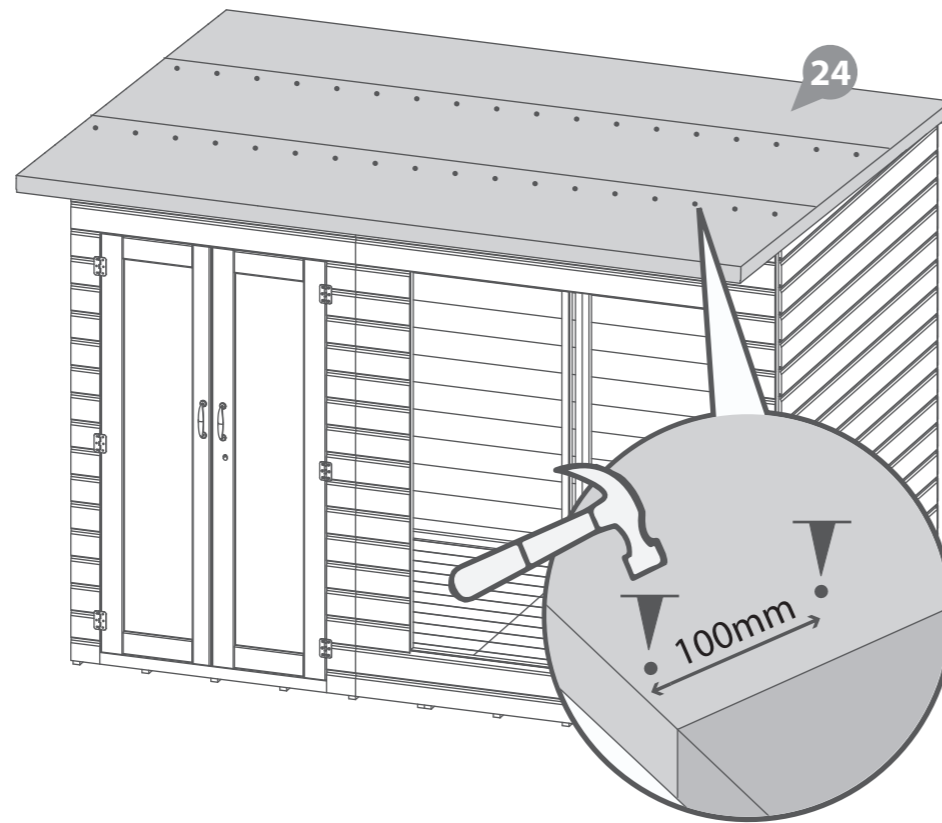

## Step 15

Parts needed - No. 16 QTY 2  
- No. 17 QTY 4

Fix the fascias (No. 16 & 17) to the front, back and sides of the building using 18x40mm screws.

Ensure the fascia fixed to the back of the roof finishes flush with the top to enable water to run off.

18x40mm Screws



**IMPORTANT: Pre-drill before fixing screws.**

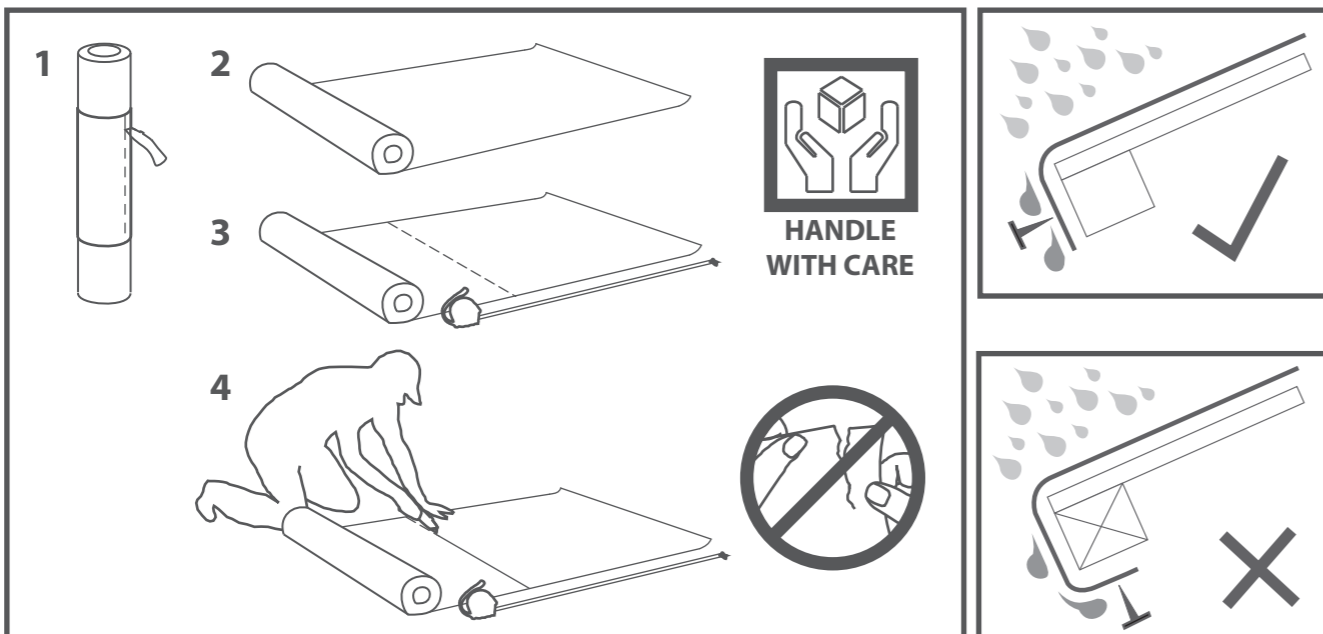
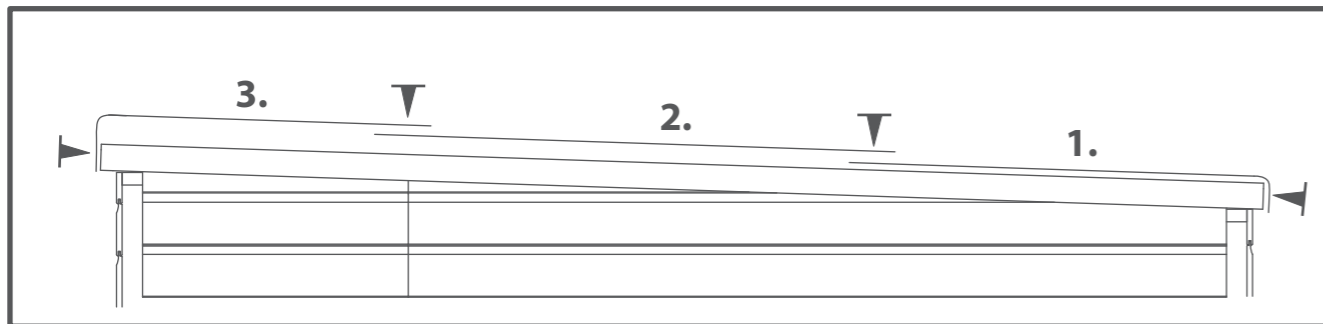
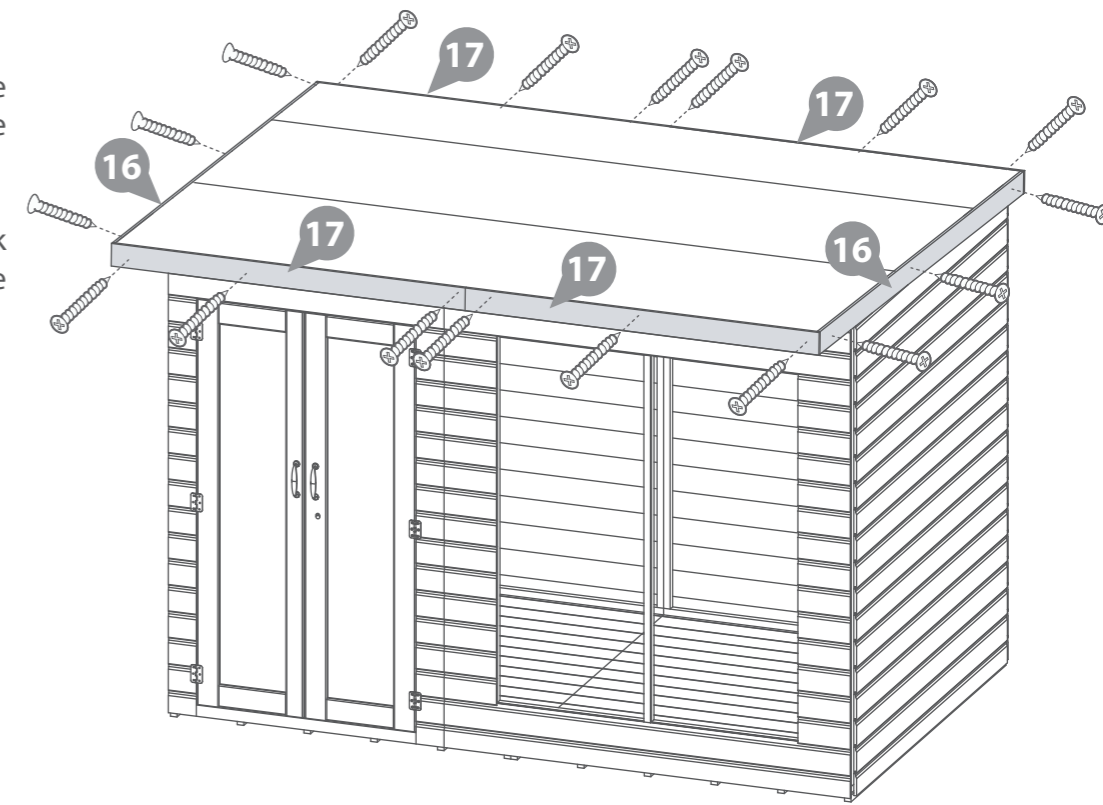

## Step 16

Parts needed - No. 11 QTY 4  
- No. 23 QTY 16

**a** Place the Windows (**No.11**) face down on a flat surface. Locate eight Window Beading Blocks (**No.23**) four down each side, on to the edges of each Window ensuring they are flush to the sides, as shown, and fix with 1x30mm screw per block.

**b** Locate the Windows centrally into the Window cut outs.

Secure the Windows into the panel by screwing through the Window Beading Blocks (**No.23**) into the Panel using 2x30mm screws per block, as shown.

**Fix the window beading blocks (No. 23) to the window before fitting the window into the panel.**

48x30mm screws.

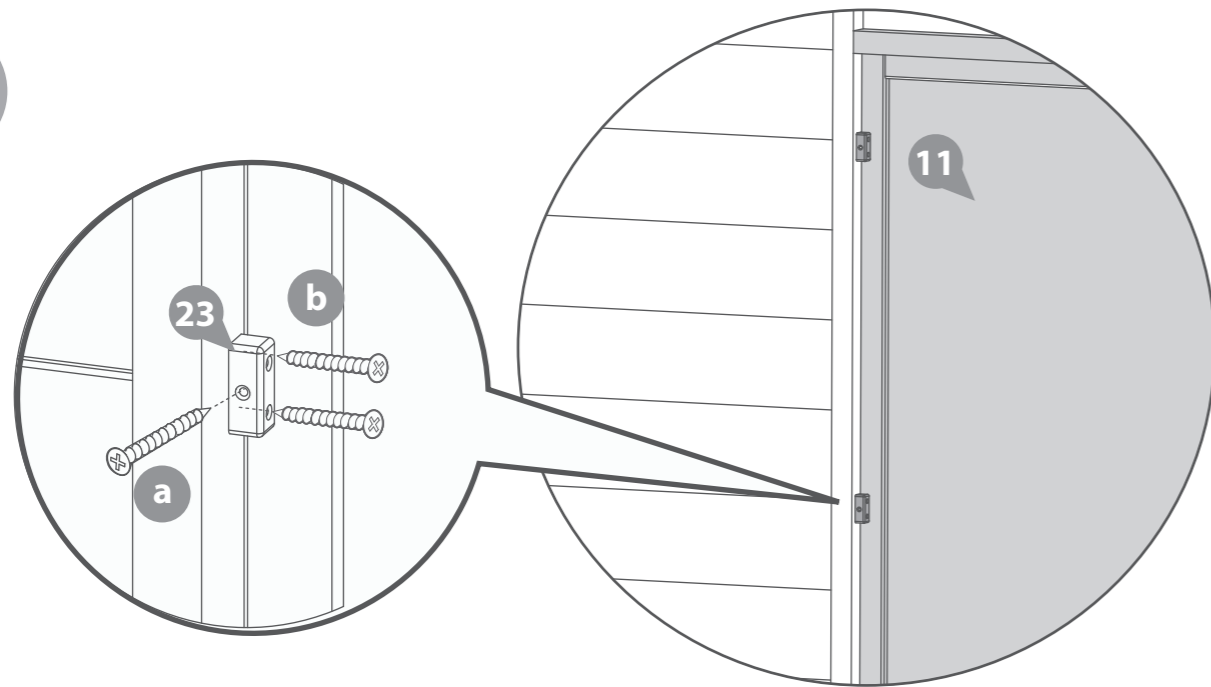

**IMPORTANT: Pre-drill before fixing screws.**

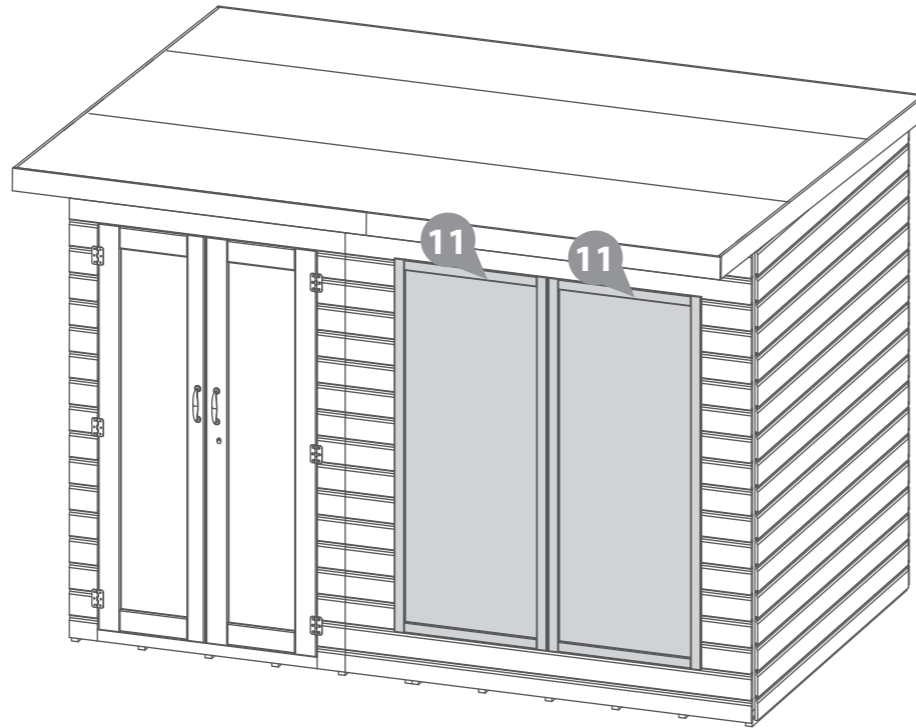

## Step 17

Parts needed - No. 12 QTY 1  
- No. 13 QTY 1

Fix a rain guard above the double doors (**No. 12**) and one rain guard above the two front windows (**No. 13**).

Secure in place using 3x50mm screws per guard, ensuring to screw through the framing at an angle.

6x50mm Screws

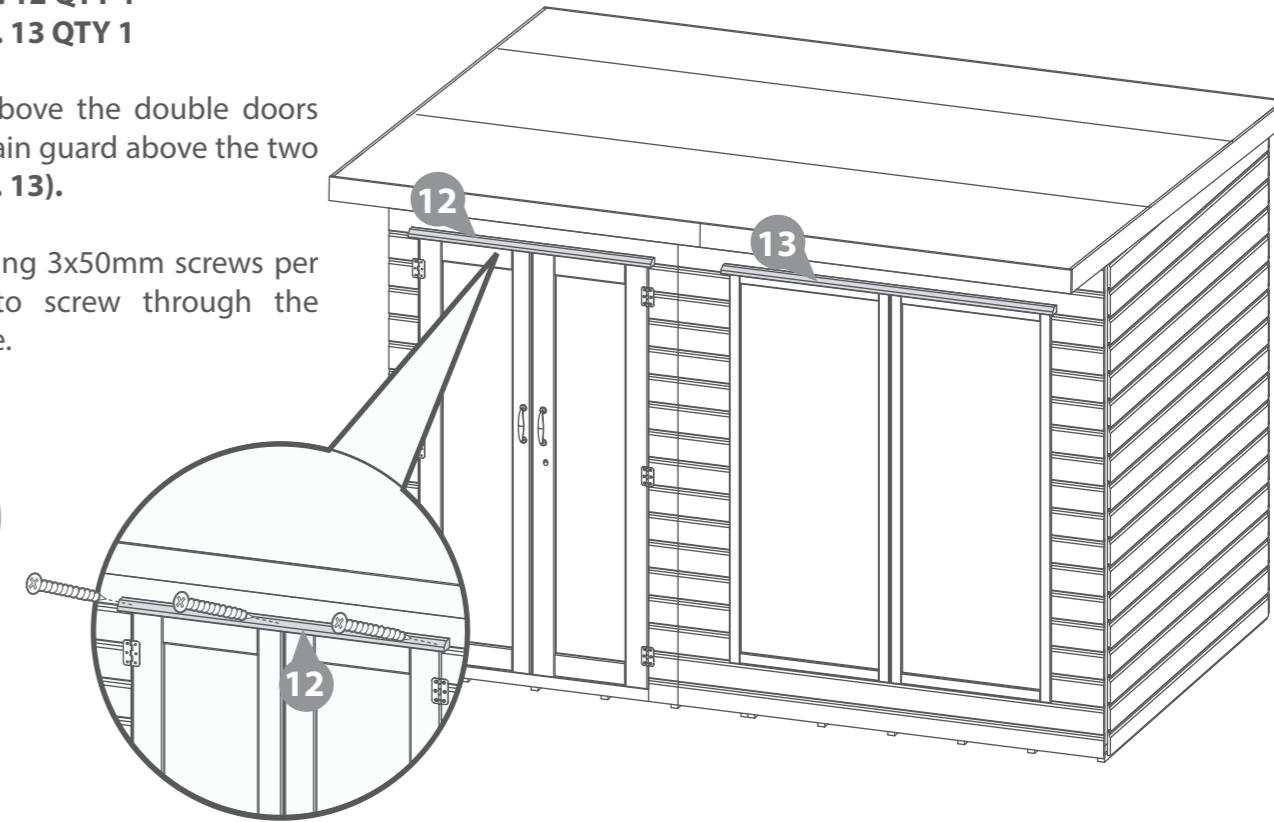

**IMPORTANT: Pre-drill before fixing screws.**

## Step 18

Parts needed - No. 14 QTY 3  
- No. 15 QTY 3

Attach the cover trims (**No. 14**) at the front and (**No. 15**) at the rear to each corner of the building and over panel joins. Use 3x30mm screws per cover trim.

18x30mm Screws

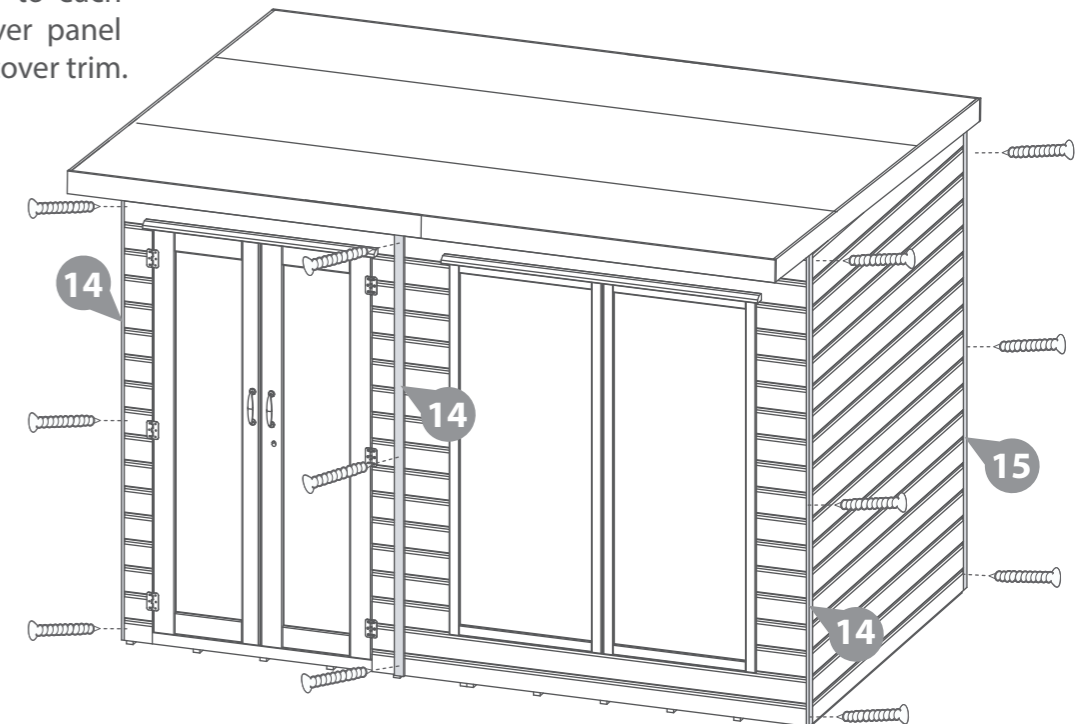
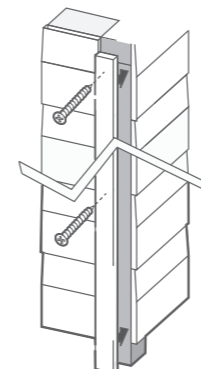

**IMPORTANT: Pre-drill before fixing screws.**

## Step 19

Parts needed - No. 25 QTY 2  
- No. 28 QTY 1

Attach the two turn buttons (No. 25) to the secondary door at the top and bottom using 2x30mm screws.

Attach the Finial (No. 28) centrally over the two front fascias using 2x30mm screws.

### 4x30mm Screws

*\*These turn buttons help to keep your doors straight during high & low levels of moisture content in the air.*

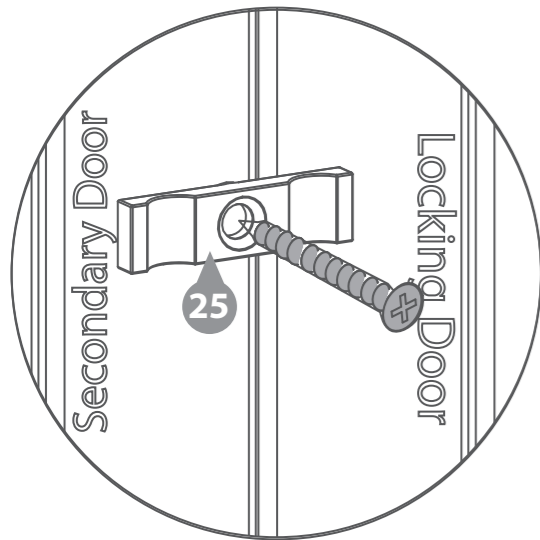
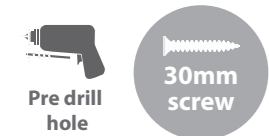

**IMPORTANT: Pre-drill before fixing screws.**

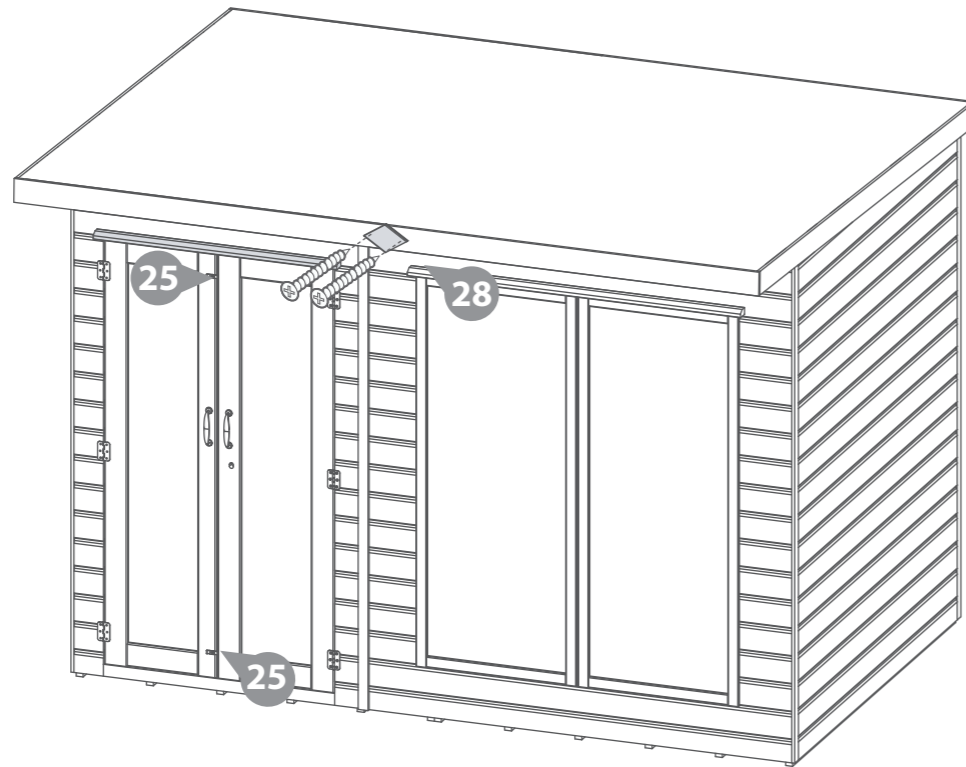

## Step 20

Parts needed - No. 18 QTY 2  
- No. 19 QTY 1

On the inside of the building fix the Door Frame Strips (No. 18 & 19), to the top and sides of the doors frames. Make sure that the edges are flush with the edge of the framing. Fix with 4x30mm screws per strip.

### 12x30mm Screws

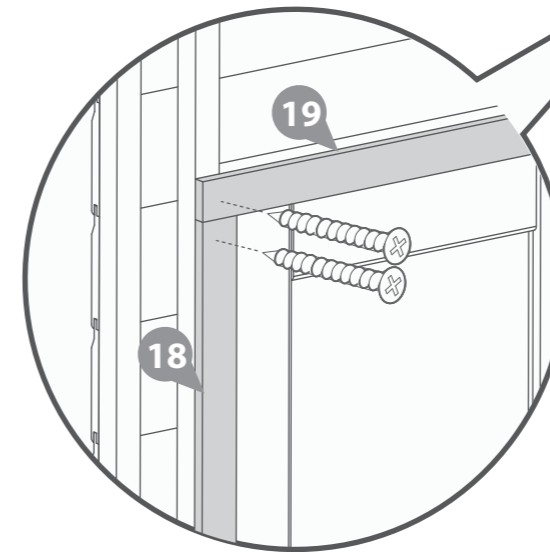
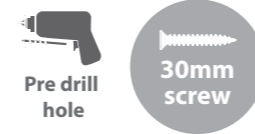

**IMPORTANT: Pre-drill before fixing screws.**

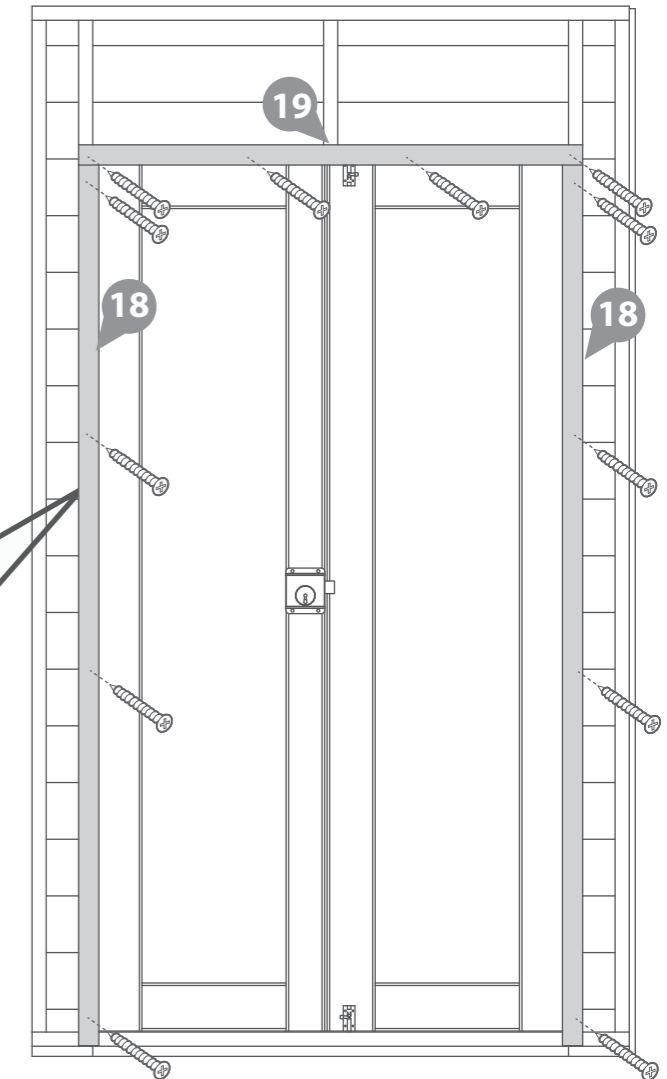

## Step 21

It is recommended that after the construction, treatment and the removal of the protective window cover that sealant is used to keep the building weather tight.

### 1. Treat the building



### 2. Remove film from the windows

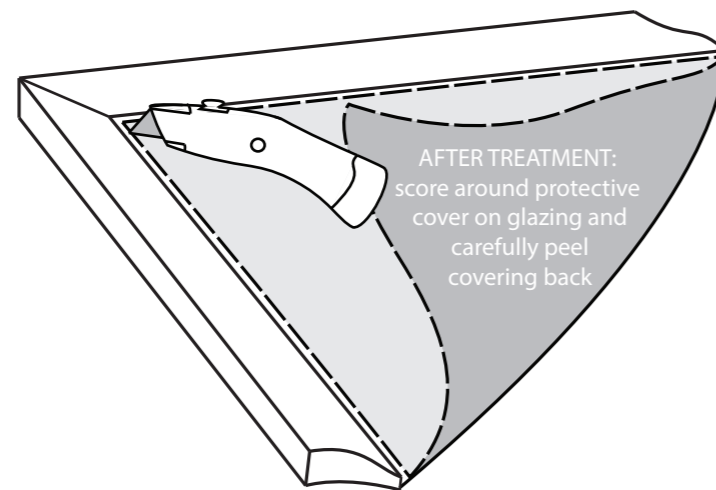

### 3. Add sealant around the windows.

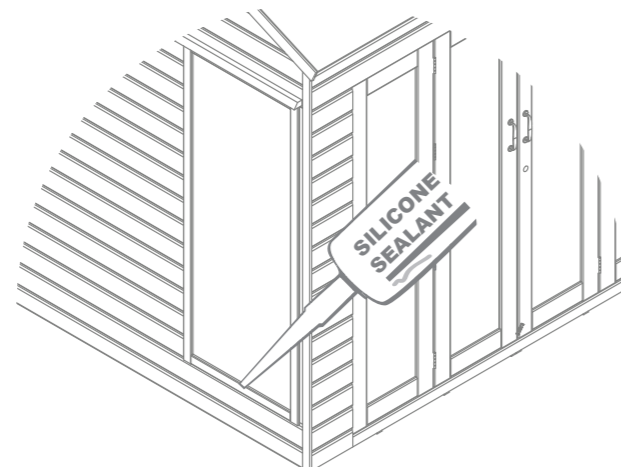

## TREATING YOUR GARDEN BUILDING

Preservation of wood that's outdoors is vital. A little early care will help protect your garden building, improve its appearance and ensure maximum longevity. Insects, moisture, salt, and changing weather can have dramatic effects on the stability and appearance of your garden building. Once your building is installed, you've checked it over and you're happy with it, you can take a few basic precautions to prepare it for the elements. Treating your garden building helps prevent decay and, by repelling water, discourages the growth of moulds and fungi that could jeopardise the structural integrity of the wood.

**Dip Treated buildings** - Require a preservative treatment to protect against rot and decay and a waterproof treatment to prevent water ingress  
**Pressure Treated buildings** - Require a waterproof treatment to prevent water ingress  
**Log Cabins/Insulated Garden Rooms** - Are supplied untreated and require a preservative and waterproofing treatment.



**ANY QUESTIONS?**  
CONTACT US ON  
01636 821215

To apply a preservative and water proofing treatment (pressure treated products do not require a preserver), follow the manufacturer's instructions but in principle, stick to the following steps:

- ✓ Wear latex or rubber gloves, eye protection and (if spraying) a mask.
- ✓ Prepare the wood, by sanding down any ridges or inconsistencies in the wood, smoothing out knots and end-cuts.
- ✓ Choose a dry day to treat your garden building. If you're spraying rather than brushing paint on, avoid a windy day.
- ✓ Be sure you can safely reach all the sections you need to paint - and if you need a ladder, make sure it's safely positioned before climbing. Lay dust sheets around to avoid paint splatters on your base or surrounding plants.
- ✓ Tape around windowpanes to avoid smears when you're painting the frames.
- ✓ Keep pets and small children out of the way. The last thing you want is to have fur on your garden building paint, or little painted footprints all over your garden and home.
- ✓ Fill any gaps in the building's body with caulk or wood filler to prevent water and draughts getting in. Silicone based caulk is flexible and will move with the timber when temperature and humidity change. Allow to dry completely before treating. A handy tip for finding gaps is to go into your garden building and look for light leaking through joins and frames. If light gets in, then so will water.
- ✓ Liberally apply at least two coats of the treatment products with a brush or spray, taking care to allow the first coat to completely dry before applying the second.
- ✓ Make sure the solution permeates the whole of the surface area, especially around natural cracks, end cuts and nail/screw holes.



APPLY WOOD TREATMENT  
**IMMEDIATELY**  
AFTER ASSEMBLY

PLEASE SCAN HERE TO  
SEE TREATMENT VIDEO:



## 1 Perimeter

Check around the perimeter of your product to ensure there are not trees or plants that are in contact with or overhanging the building. This can affect airflow and overhanging trees, or branches can damage the roof, it is advised to keep plants at a distance.

## 2 Repair

Inspect the interior and exterior of the product to look for splits, cracks, and holes. Although this is a natural occurrence it can be prevented. A wood filler can be used to close the splits, cracks, and holes.

## 3 Roof

Check your roof regularly for tears, splits, damaged wood and fallen debris. If you notice any of this immediate repair is critical.

## 4 Doors & Windows

Expansion and contraction can cause doors and windows to stick or become difficult to open. Small adjustments to the hinge position can be made to the doors and windows to allow free movement.

## 5 Oil

Hinges can seize up over time, apply lubricant to the hinges and locks annually.

## 6 Screws & Bolts

It is advised to check all screws and bolts and tighten any loose you might find. For log cabins specifically the storm braces will require loosening. During humidity and temperature changes (seasons) to allow expansion and contraction to prevent gaping, twisting, popping, and warping.

## 7 Wash

At least once a year, give the outside of your building a good wash, to remove cobwebs, leaves, or any other dirt that may accumulate on the exterior.

## 8 Airing

Airing your product regularly prevents the build up of condensation which can cause the timber to warp, bow, boards to pop, distortion, rot and mould. Condensation can build up over time or daily, it is caused by a rise and fall in temperature.

Excessive moisture levels within your building can cause water to collect on the roofs, walls and floors internally. Leaving doors and windows open regularly can help combat the natural moisture build up.

## 9 Clean & Tidy

It is good practice to clean the inside and outside of your product regularly. Clear out the contents, sweep the floor, remove dirt and cobwebs. Check for areas of damp and investigate the cause to remove and prevent future occurrences. Check the ground around your product for build up of debris such as leaves, remove and ensure there is clear ventilation underneath the floor.

### Additional Playhouse Maintenance:

It is recommended that the following checks and maintenance are carried out at the beginning of each season as well as at regular intervals during the usage season.

- Check all nuts /bolts/ screws for tightness and tighten when required.
- Check for movement / opening of wood giving rise to protrusion of nail heads and tips.
- Check hinges.
- Replace defective parts in accordance with the manufacturers instructions.
- Check any crossbeams, suspensions and anchors.
- If a swing is included; check the swing seat, chains and ropes.

**IF THESE CHECKS ARE NOT CARRIED OUT THE ACTIVITY TOY COULD BECOME A HAZARD**

All our garden buildings have been designed and manufactured with care and attention to be the perfect addition to your outdoor space. To ensure you do get the best out of your new garden building and to increase the longevity we advise that you follow the product instructions and our manufacturer's recommendations as detailed below. Thank you for choosing a Mercia Garden product!

## 1 Choosing the most suitable location for your garden building...

A minimum of 60cm should be left around the perimeter of your garden building to allow access for maintenance, annual treatment and to allow air flow around the building.

Where possible you should avoid placing your garden building underneath large trees to prevent the tree causing damage to the building.

## 2 Preparing the base for your garden building...

All our buildings must be built on a firm, level base to ensure the longevity of the building and prevent the wood from distorting. We recommend either concrete, concrete slabs or a wooden base, such as our 'Portabase'.

The base should be slightly smaller than the external measurement of the building, i.e. the cladding should overlap the base, creating a run off for water and preventing water from pooling underneath the building.

We also recommend that the floor of the garden building is a minimum of 25mm above the surrounding ground level to avoid flooding.

## 3 After installation...

Once your garden building has been installed, it will need to be treated within 14 days (weather permitting) and annually to prevent the timber from deteriorating and to waterproof it. This is required to maintain the anti-rot guarantee.

Dip Treated buildings - Require a preservative treatment to protect against rot and decay

and a waterproof treatment to prevent water ingress.

Pressure Treated buildings - Require a waterproof treatment to prevent water ingress.

Log Cabins/Insulated Garden Rooms - Are supplied untreated and require a preservative and waterproofing treatment.

We also recommend using a silicon sealant on the inside and outside of the windows as soon as possible after assembly and treatment to fully seal the windows.

Roofing felt/covering should be checked annually and replaced or fixed accordingly.

## 4 General maintenance and wood characteristics

As wood is a natural material it may be affected by the following:

**Shrinkage and warping** - The timber used in the construction of your garden building will have retained some of its natural moisture content. The moisture content of the timber will vary, depending upon prevailing environmental conditions, which will result in the components either naturally expanding or contracting. As the components dry out, shrinkage may occur. A good waterproofing treatment from the start is the best protection to minimise the effect of moisture loss/intake.

In extended periods of very warm weather getting some moisture to the building will help the overall balance. You can do this by spraying it down lightly with a garden hose. In contrast, after snow fall try to remove the snow as best as possible from the roof to prevent moisture intake and to remove the extra weight.

Top tip - using a garden brush will help you to reach the highest part of the building to remove snow and any debris left from bad weather.

**Damp and mould** - During the winter months, cold and damp conditions can result in an increased amount of moisture within your garden building, especially when used infrequently. Condensation can form on the timber and other items stored within your garden building. If left this moisture is likely to cause mould and mildew.

To prevent the build-up of moisture, we recommend leaving the door or windows of your building open from time to time, to allow the fresh air to circulate. We also advise against storing wet or damp items in your garden building as this will also increase the level of moisture in the building. If mould or mildew does start to form within your building we recommend using an anti-mould cleaner to remove it and to prevent it spreading, which if left untreated could permanently damage your garden building.

**Splits, cracks and knots** - You may notice small splits and cracks in some components or holes may appear where knots shrink and fall out. This will not affect the structure of your Garden building however, if you wish to fill them this can be easily done using any good quality wood filler.

**Sap** - is naturally occurring in wood and may appear in some boards of your garden building. If you wish to remove the sap, we advise waiting until it is dry and then using a sharp knife to carefully remove it. If the removal of the sap causes a hole in the timber, we recommend using a good quality wood filler to fill it.

For more handy hints and tips on how to care and maintain your garden building please refer to the MGP Customer Portal at [www.mgplogistics.co.uk](http://www.mgplogistics.co.uk)

Any further questions?

Contact our  
Customer Service  
Team on:  
01636 821215

## 1

### Manufacturer's Warranty

All Mercia Garden Products are supplied with a 1 year warranty on all parts against manufacturing defects.

This warranty does not cover movement, warping or splitting of timber products over time.

This warranty will be voided if any of the following occur:

1. The building has been customised or modified/adapted in any way.
2. The person claiming is not the original purchaser of the building.
3. Any damage has been caused by or as a result of misuse.
4. The building has not been maintained and cared for in accordance to our advisories and manufacturer's recommendations.
5. The building has not been treated annually or as per the manufacturer's recommendations, please ensure receipts are kept to validate this claim.
6. The building has not been erected, fitted or installed as per the supplier instructions.
7. The building has not been erected on a suitable sized firm flat, solid level concrete/slab base or placed on pressure treated bearers.
8. The building is or has been placed with 2 feet (600mm) of any obstructions (walls, trees, plants, fences etc.) which can allow moisture to penetrate the timber.
9. The roofing felt has been incorrectly fitted or damaged, allowing water ingress, or has not been properly maintained.
10. Any windows and joints have not been sealed, inside and out, with silicone or other watertight sealant.
11. Any timber has been cut, pierced or drilled without subsequent application of approved cut-end treatment.

## 2

### Anti-rot Guarantee

Mercia Garden Products offer a 10 year anti-rot guarantee on all dip treated (a preparatory treatment) and 15 years on all pressure treated products. This guarantee covers solid timber against rot, decay, blue stain and insect attacks.

To validate the guarantee, the building must be treated (as detailed within manufacturer's recommendations) within 14 days (weather permitting) of assembly and annually thereafter.

This guarantee does not cover movement, warping or splitting of timber products over time.

This guarantee will be voided if any of the following occur:

1. The building has been customised or modified/adapted in any way.
2. The person claiming is not the original purchaser of the building.
3. Any damage is caused by or as a result of misuse.
4. The building has not been maintained and cared for in accordance to our advisories and manufacturer's recommendations.
5. The building has not been treated annually or as per the manufacturer's recommendations, please ensure receipts are kept to validate this claim.
6. The building has not been erected, fitted or installed as per the supplier instructions.
7. The building has not been erected on a suitable sized firm flat, solid level concrete/slab base or placed on pressure treated bearers.
8. The building is or has been placed with 600mm of any obstructions (walls, trees, plants, fences etc.) which can allow moisture to penetrate the timber.
9. The roofing felt has been incorrectly fitted or damaged allowing water ingress, or has not been properly maintained.
10. Any windows and joints have not been sealed, inside and out, with silicone or other watertight sealant.
11. Any timber has been cut, pierced or drilled without subsequent application of approved cut-end treatment.



REGISTER FOR YOUR  
**ANTI-ROT**  
GUARANTEE TODAY

PLEASE SCAN HERE:

