

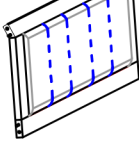

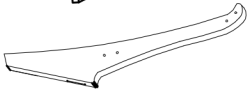

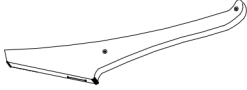

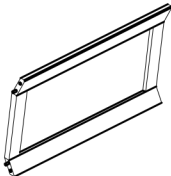

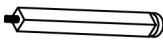

ASSEMBLY INSTRUCTIONS

PARTS IDENTIFICATION



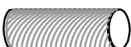

A	HEADBOARD		1PC
B	LEFT HEADBOARD LEG		1PC
C	RIGHT HEADBOARD LEG		1PC
D	FOOTBOARD		1PC
E	LEFT FOOTBOARD LEG		1PC
F	RIGHT FOOTBOARD LEG		1PC
G	BED RAIL		2PCS
H	BED SLAT		4PCS
I	BED SLAT SUPPORT WITH LEVELER		4PCS

HARDWARE IDENTIFICATION

HB

1 BOLT		4PCS
2 LOCK WASHER		4PCS
3 FLAT WASHER		4PCS
4 ALLEN WRENCH		1PC
5 WOOD CAP		4PCS
6 WOOD PIUG		4PCS

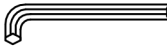
FB

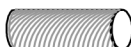
1 BOLT		4PCS
2 LOCK WASHER		4PCS
3 FLAT WASHER		4PCS
4 ALLEN WRENCH		1PC
5 WOOD CAP		4PCS
6 WOOD PIUG		4PCS

SL

7 FLAT HEAD SCREW		8PCS
-------------------	---	------

STEP 1

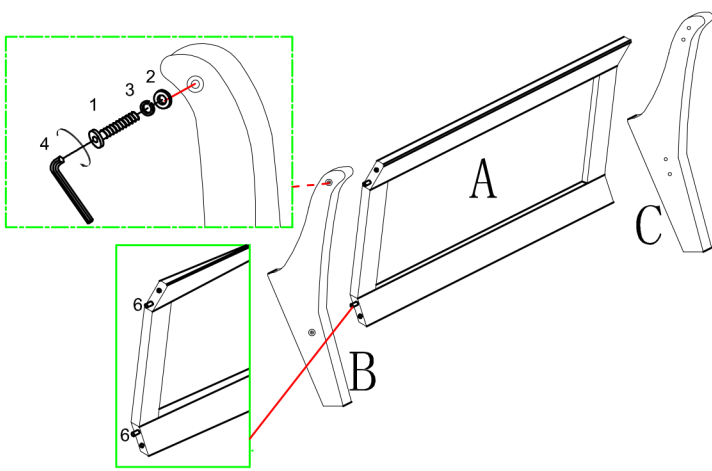

STEP 2

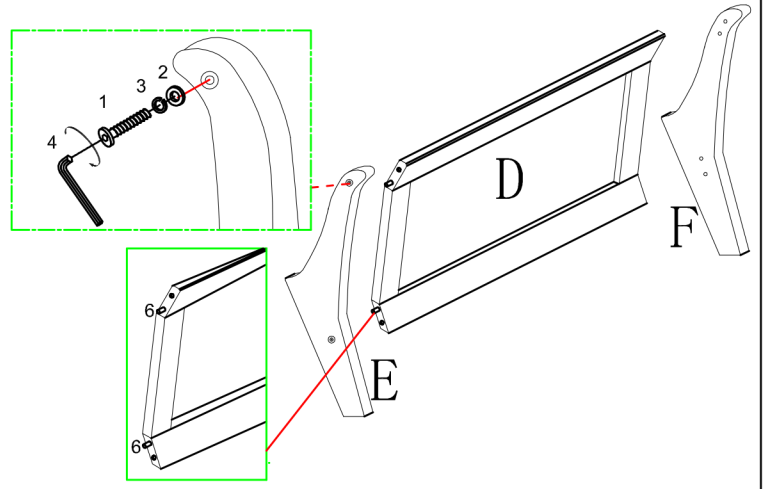

STEP 3

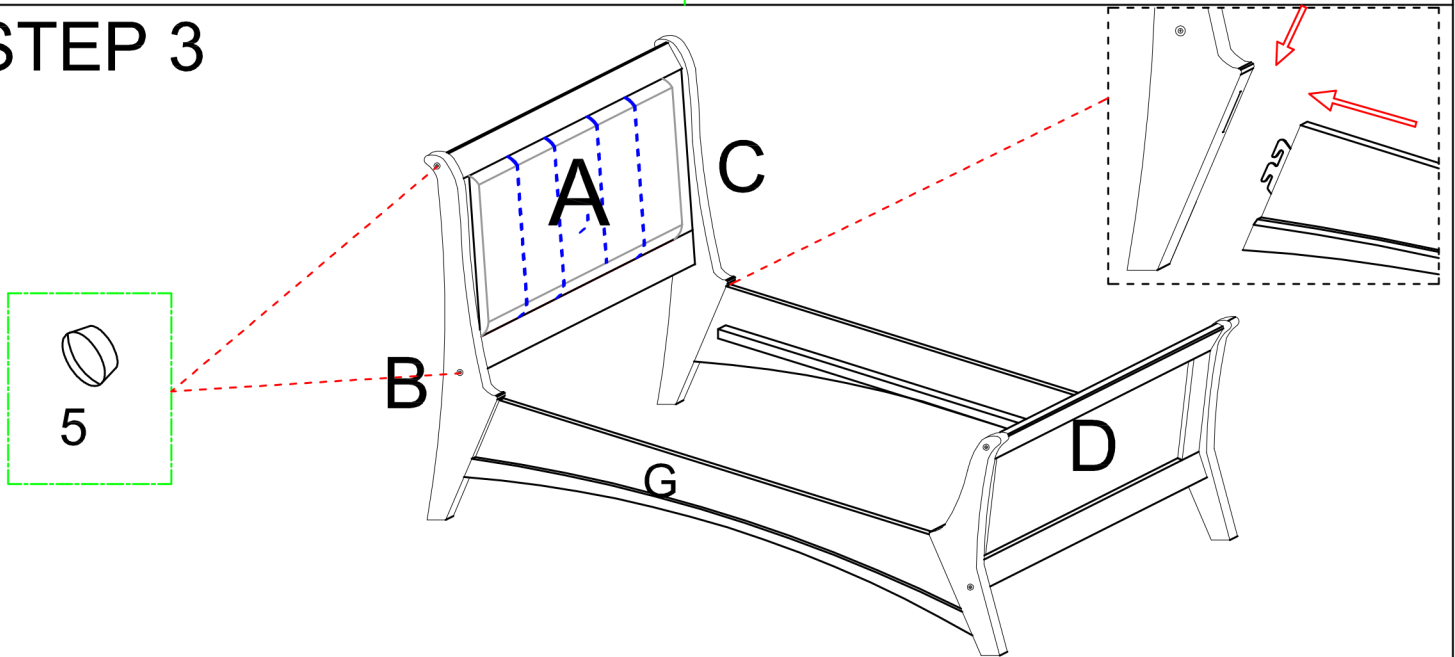

STEP 4

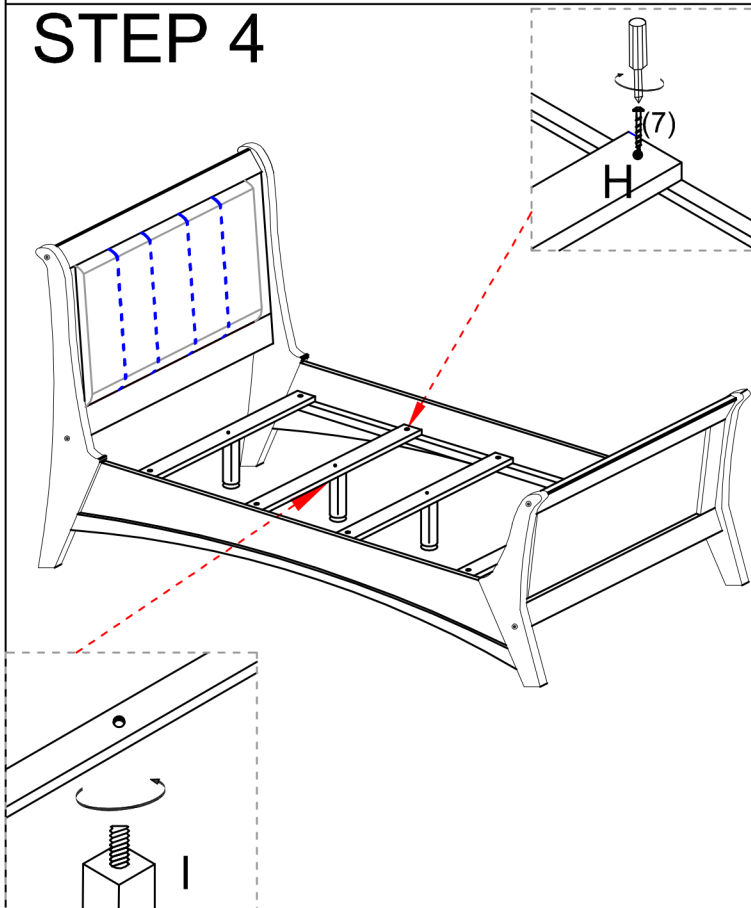

STEP 5

