



## **OWNER MANUAL**

Thank you for purchasing the Dining Table.

Please read the instructions and warnings carefully before use, to ensure safe and satisfactory operation of this product. We are committed to making great products possible. From our in-house Design Team, to our Buyers, we work together to bring great designs to life. Our expert Product Technologists work collaboratively with our buyers and suppliers to assure the legality, safety and quality of the product we sell. We are all committed to designing and developing products to the highest industry standards. We hope you are happy with your product and welcome any feedback or comments you may have.

# EXPLOSIVE VIEW

## Dining Table

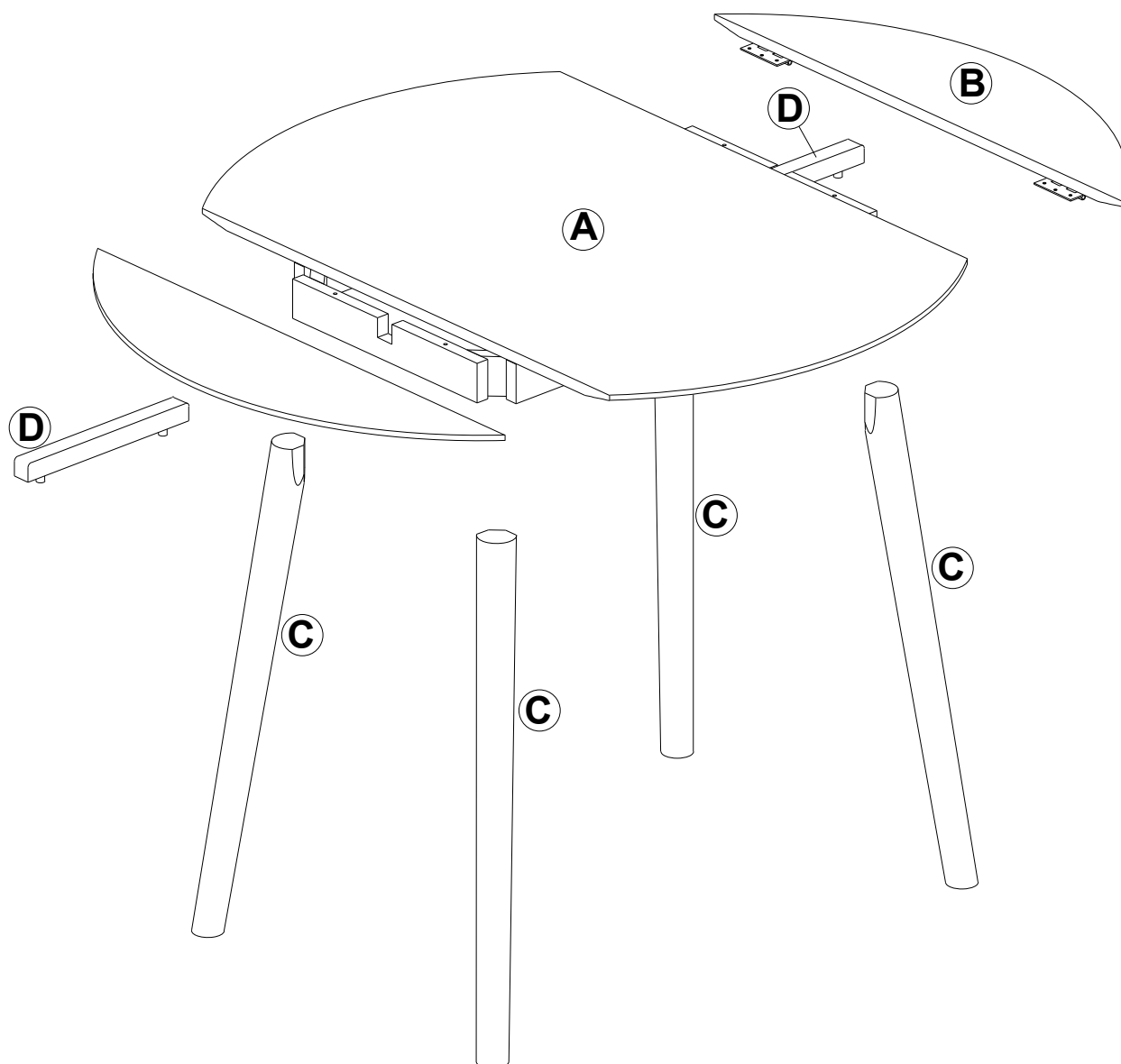

# ! IMPORTANT

Please follow the instruction manuals and use a pad to protect the product during your assembly.

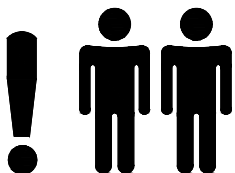
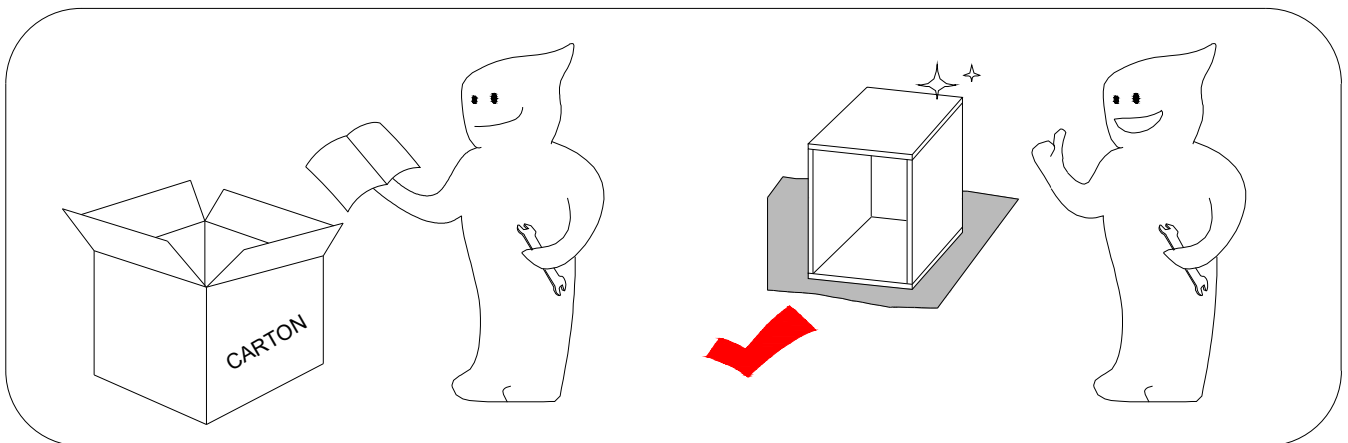
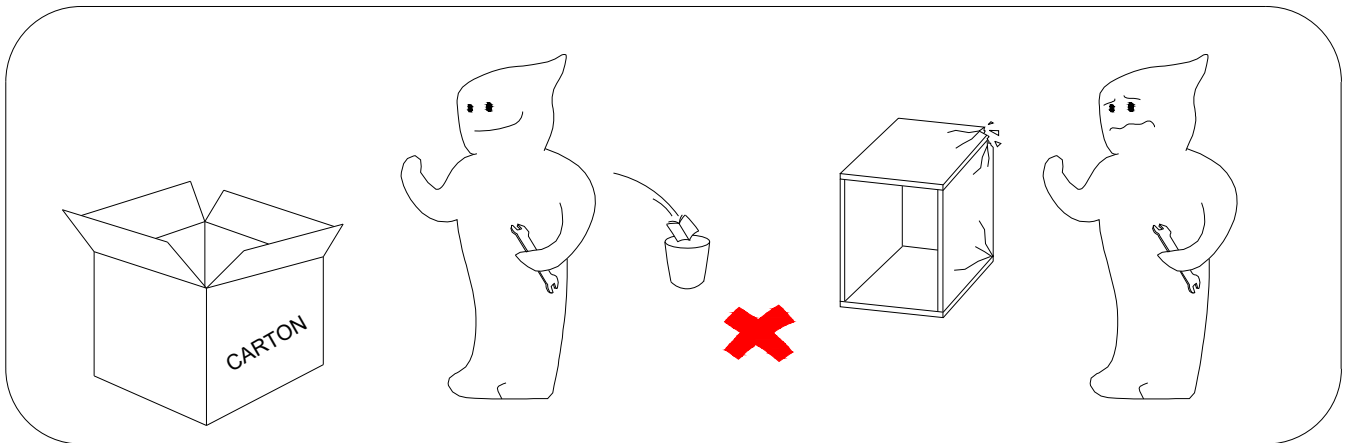

Recommend 2 adults for quicker assembly.

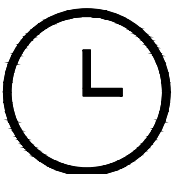



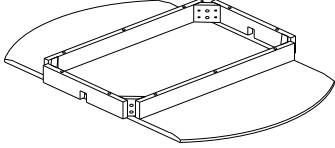
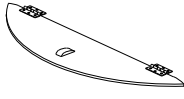
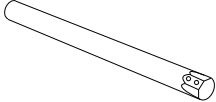
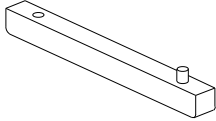

Take 2 adults about 25 minutes to finish assembly.

## PARTS LIST

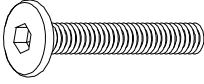
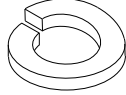
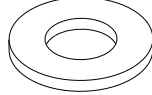
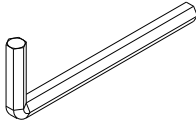
<p><b>A</b> x 1</p>  <p>Table Top</p>	<p><b>B</b> x 2</p>  <p>Side Leaf</p>	<p><b>C</b> x 4</p>  <p>Leg</p>
<p><b>D</b> x 2</p>  <p>Wooden Bars</p>		

## HARDWARE LIST

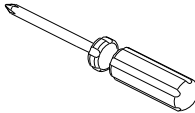
<p><b>1</b> x 8</p>  <p>Bolt Ø5/16"*2-3/8"L</p>	<p><b>2</b> x 8</p>  <p>Spring Washer Ø5/16"</p>	<p><b>3</b> x 8</p>  <p>Flat Washer Ø5/16"</p>
<p><b>4</b> x 1</p>  <p>Allen Wrench 4#</p>	<p><b>5</b> x 4</p>  <p>Screw #8*50mm</p>	<p><b>6</b> x 12</p>  <p>Screw #8*15mm</p>
<p><b>7</b> x 2</p>  <p>Wood Dowel</p>	<p><b>8</b> x 1</p>  <p>Screwdriver (Not included)</p>	

Be sure to check all packing material carefully for small parts, which may have come loose inside the carton during shipment.

# ASSEMBLY INSTRUCTION

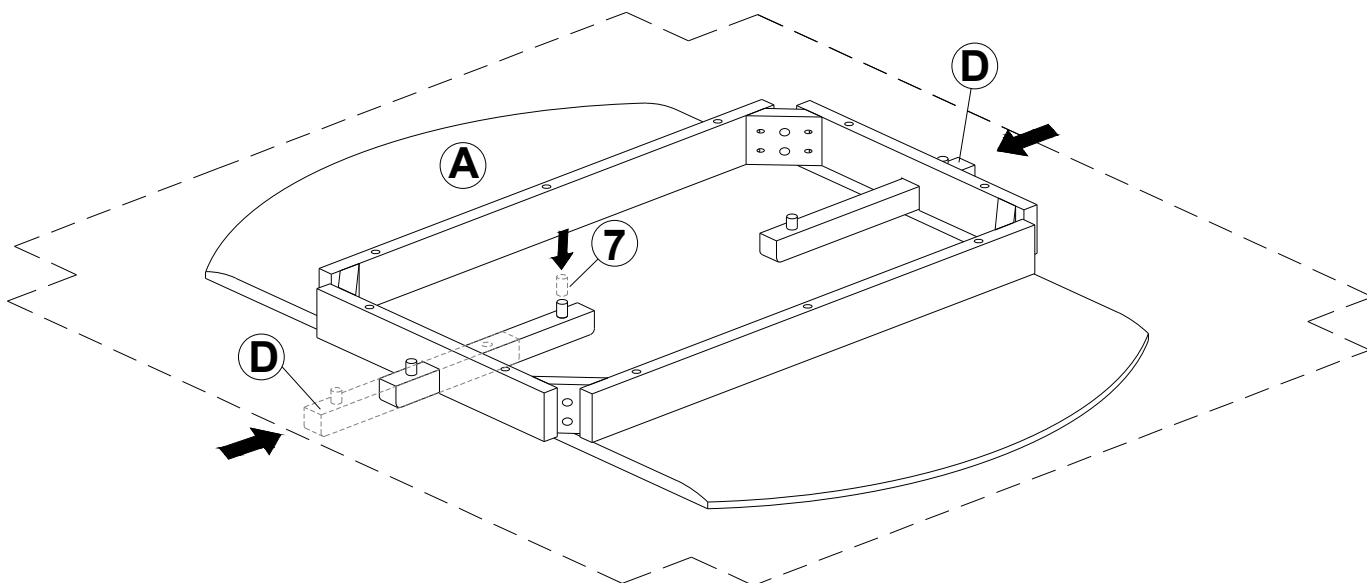

## STEP 1

7		x 2
---	---	-----



Pass the wooden bar (D) through the wooden frame, and then install it on the wooden bar (D) with wood dowel (7), as shown in the picture.

## STEP 2



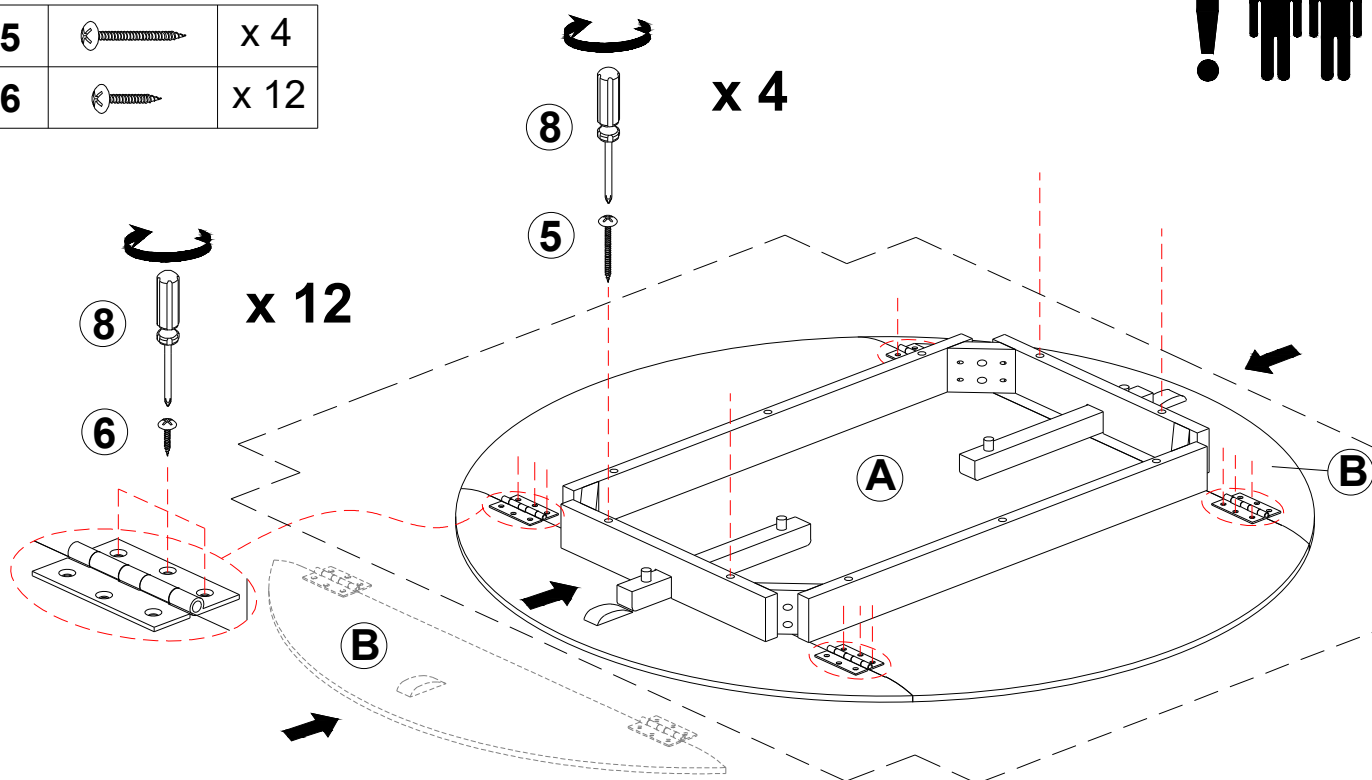

5		x 4
6		x 12



Place the side leaf (B) on the designated table top (A). Use the screws (6) provided by you to quickly tighten the hinges.

Then use the screws (5) you provided to fasten the frame and the side panels together.

### STEP 3

1		x 8
2		x 8
3		x 8
4		x 1

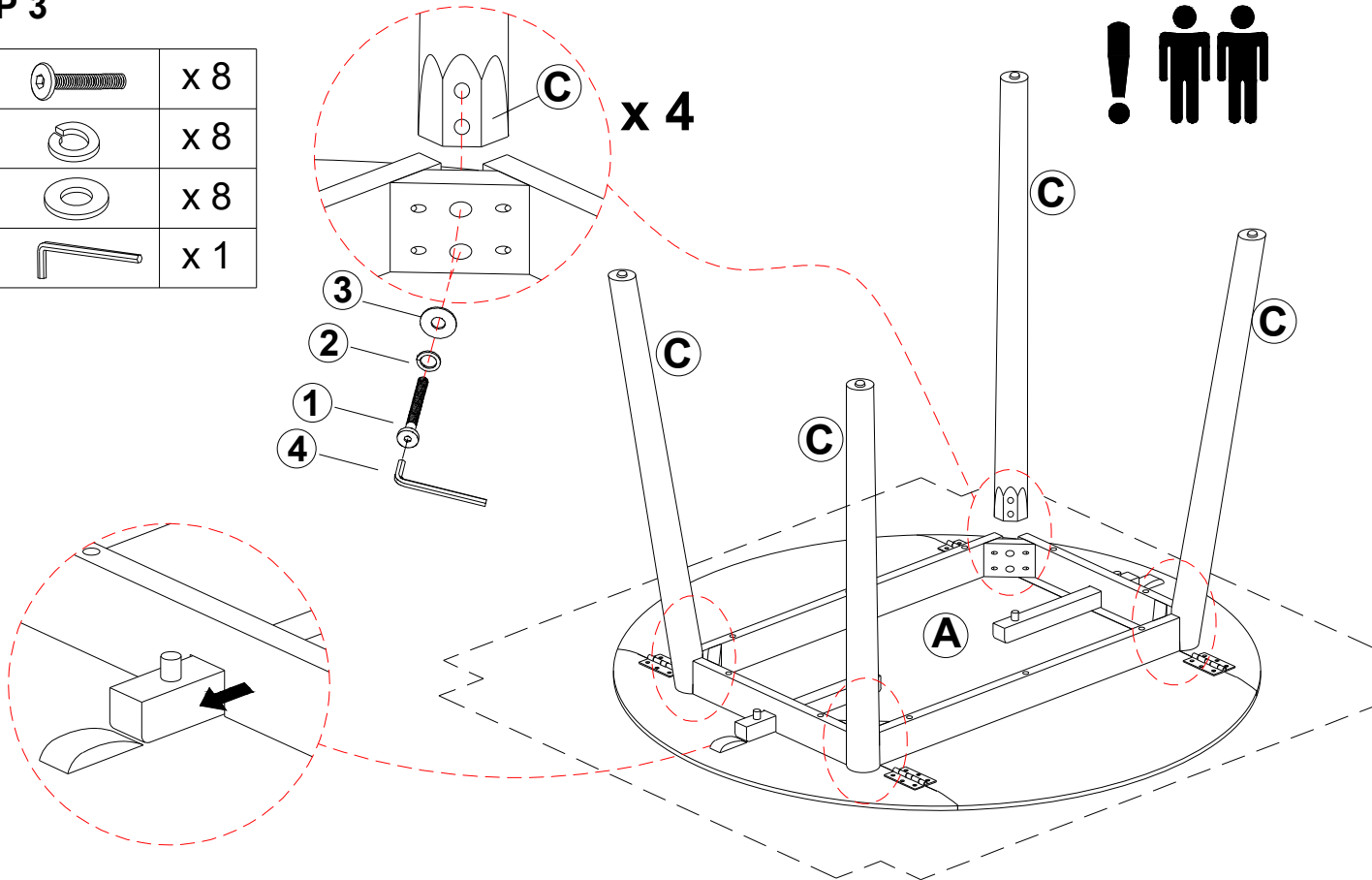

Use Bolt(1), spring washers (2), and flat washers (3) and allen wrench (4) to assemble the table top (A) with table legs (C).

### STEP 4



After installation, Please keep the table balanced, tighten all bolt.

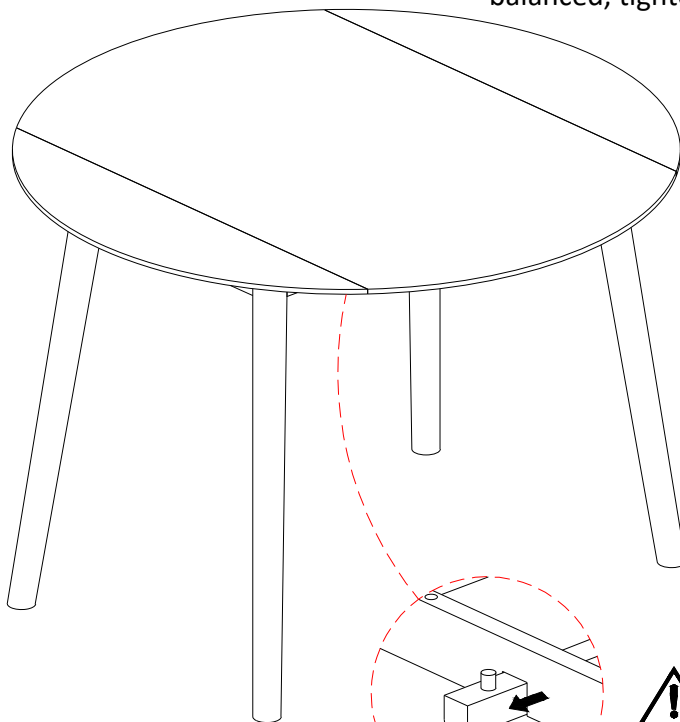
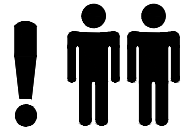

Gently pull the crossbar outward to support the side leaf

## MAINTENANCE AND WARNING



- Keep furniture away from heat.
- Do not clean furniture with harsh cleansers or polish. Do not use detergents, Solvents, abrasives, spray packs or leather cleaner. Use non-color mild soap with warm water clean spills(Mix 1:10 soap to water)
- Do not place furniture under direct sunlight, material will possibly fade over time.
- Do not use on site dry Cleaning machine.
- Children should not climb or jump on the furniture.
- Do not write on furniture without a padded barrier to protect the surface.
- Not for commercial use, For residential use only.
- The maximum load is 150 LBS.

## WARRANTY

We strive to offer high , quality products, and we also try our best to satisfy each and every customer that orders from us with product or service as needed. We provide 30 days warranty starting from the time you receive the item. Each customer must provide a record of their order such as the order number, or item receipt for any items that are out of the warranty period you may also still receive replacement parts by purchasing them with our company if they are available.

Are you having difficulty with assembly? Missing parts? Please send email with your order No For return, please check the return policy with the retailer or market place you bought from. Appreciate your purchasing from us. Pop up your life by our furniture piece!