

Installation & Assembly

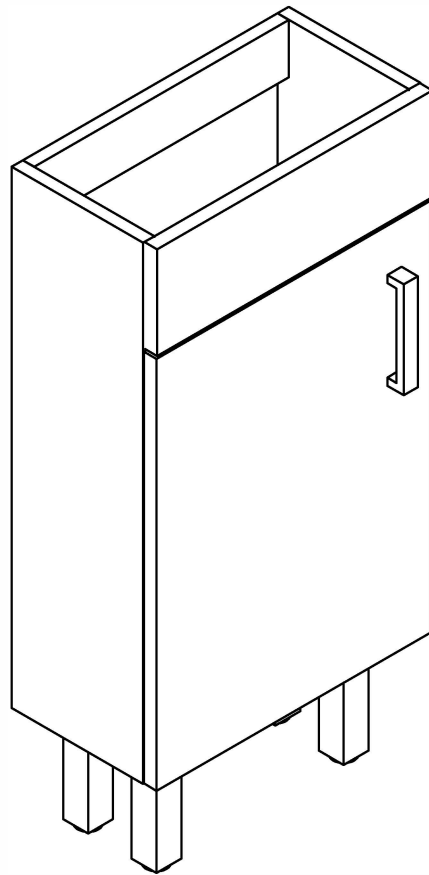

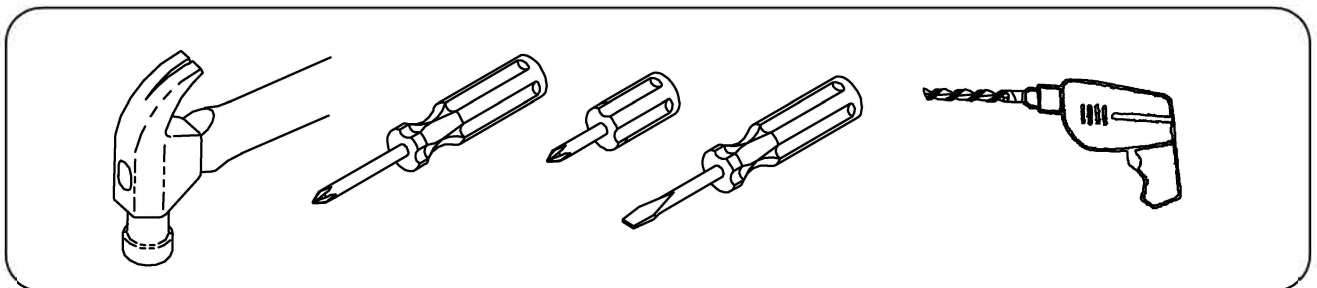





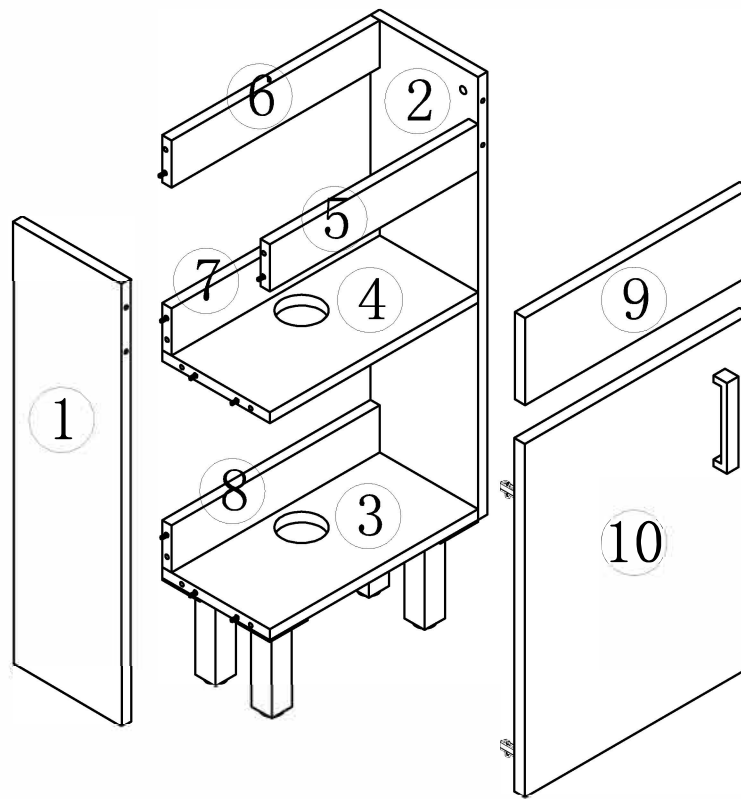











YOU MAY NEED (NOT SUPPLY)



ASSEMBLY DIAGRAM



| PARTS LIST | | | | | |
|------------|--|-----|----|---|-----|
| PARTS LIST | | | | | |
| NO | DESCRIPTION | QTY | NO | DESCRIPTION | QTY |
| ① | Left side panel  | 1 | ⑥ | Rear baffle  | 1 |
| ② | Right side panel  | 1 | ⑦ | Rear baffle  | 1 |
| ③ | Bottom panel  | 1 | ⑧ | Rear baffle  | 1 |
| ④ | Clapboard  | 1 | ⑨ | Front sealing plate  | 1 |
| ⑤ | Front drawbar  | 1 | ⑩ | Left door panel  | 1 |
| | | | | | |
| | | | | | |

| PARTS LIST | | | | | |
|--|---|-----|----|--|-----|
| HARDWARE LIST | | | | | |
| NO | DESCRIPTION | QTY | NO | DESCRIPTION | QTY |
| A | Three-in-one eccentric wheel  | 20 | F | Aluminum alloy leg  | 4 |
| B | Three-in-one connecting rod  | 20 | G | 4*16mm screw  | 24 |
| C | Three-in-one sticker  | 20 | H | 4*23mm screw  | 2 |
| D | 8*40mm wood dowel pins  | 16 | I | Door handle  | 1 |
| E | Door hinges  | 2 | | | |
| | | | | | |
| CAUTION: Please confirm the parts list before installation | | | | | |

STEP 1

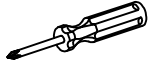
| HARDWARE LIST | |
|--|---|
| Three-in-one connecting rod B 20PCS |  |

1. Put the three-in-one connecting rod in the 10mm hole of the following panels and tighten them with a cross screwdriver or an electric tool.

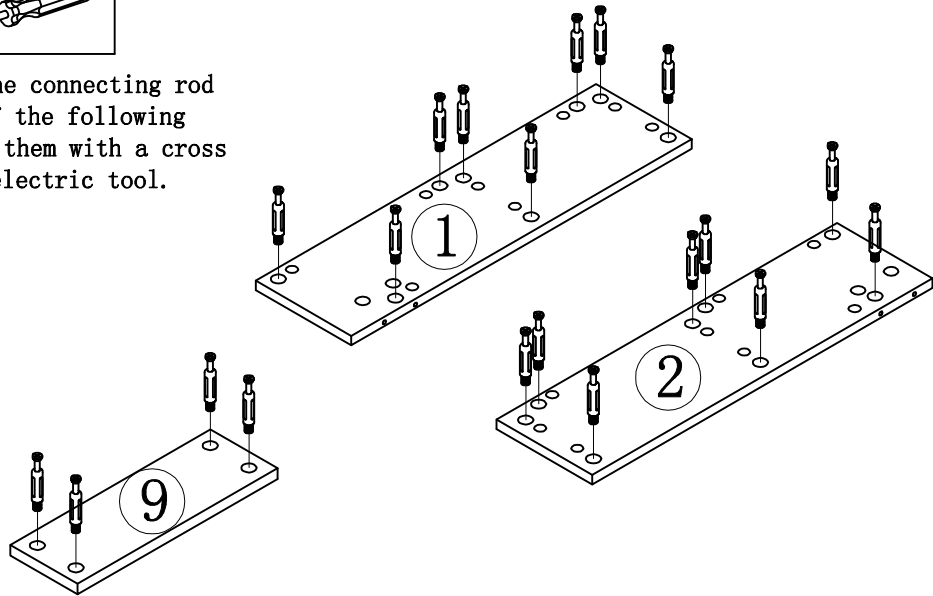
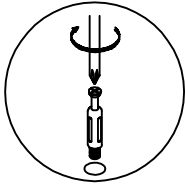

STEP 2

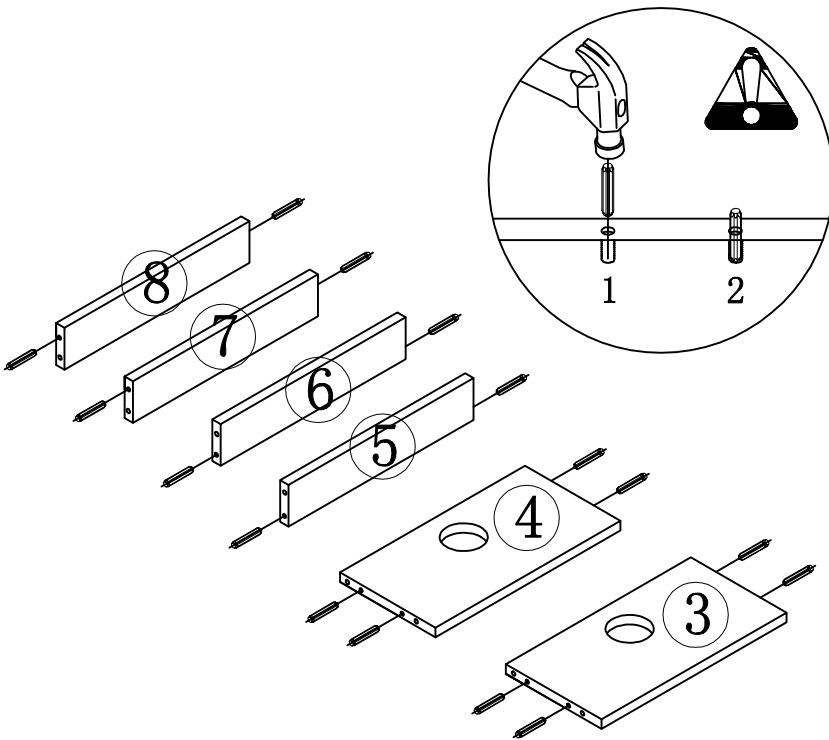

1. Strike the 08*40mm wood dowel pin into the 8mm hole of the above panels with an iron hammer. Please note that the hole of the three-in-one connecting rod should also be 8mm. The hole of the three-in-one connecting rod connects to the hole of 15mm three-in-one eccentric wheel.

| HARDWARE LIST | |
|-----------------------------------|---|
| 8*40mm wood dowel pins D 16PCS |  |

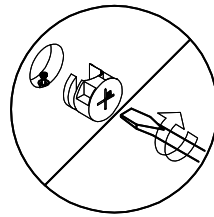
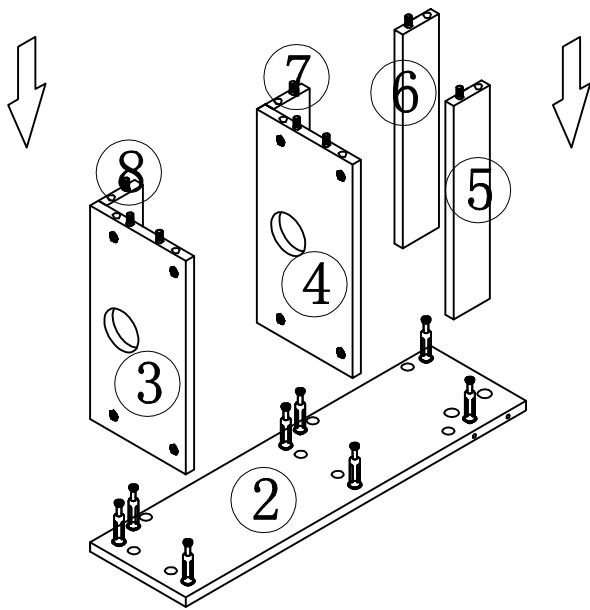

STEP 3

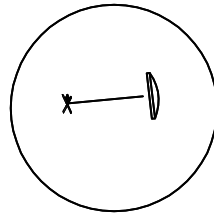

1. Connect No. 3-4-5-6-7-8 panel to No. 2 panel tightly with the three-in-one eccentric wheel.



2. Cover the mounting hole of the eccentric wheel with a three-in-one sticker.

| HARDWARE LIST | | |
|---|---|--|
| Three-in-one eccentric wheel A  8PCS | Three-in-one sticker C  8PCS |  |

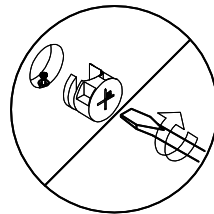
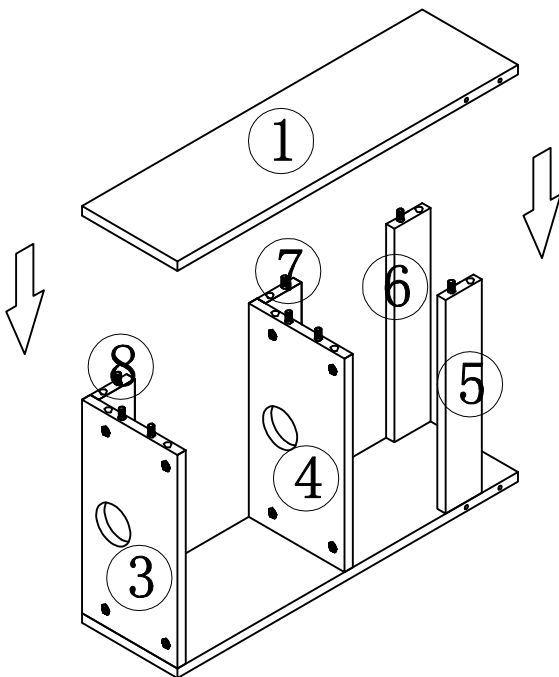

STEP 4

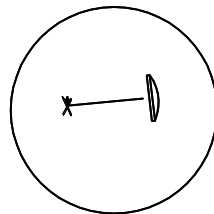

1. Connect No. 1 panel to No. 3-4-5-6-7-8 panel tightly with the three-in-one eccentric wheel.





2. Cover the mounting hole of the eccentric wheel with a three-in-one sticker.

| HARDWARE LIST | | |
|--|--|---|
| Three-in-one eccentric wheel A  8PCS | Three-in-one sticker C  8PCS |  |

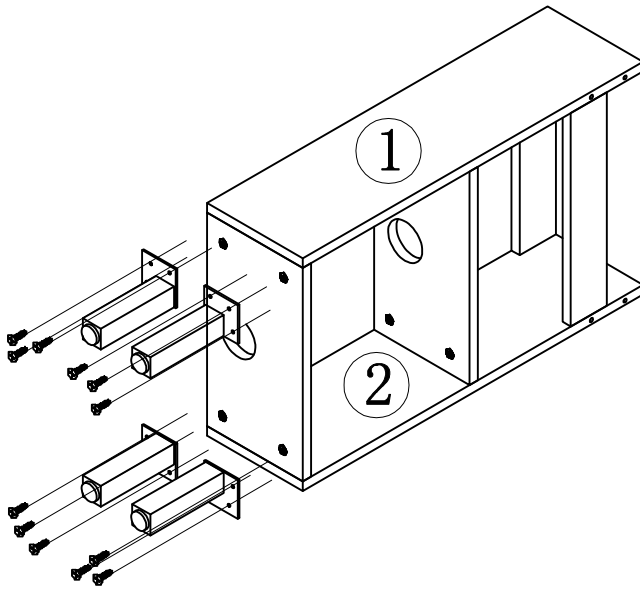
STEP 5



Use 4*16 screws to fix the aluminum alloy feet

| HARDWARE LIST | | |
|---|--|--|
| 4*16mm screw | Aluminum alloy leg |  |
| G  12PCS | F  4PCS | |

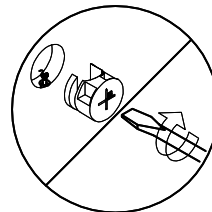
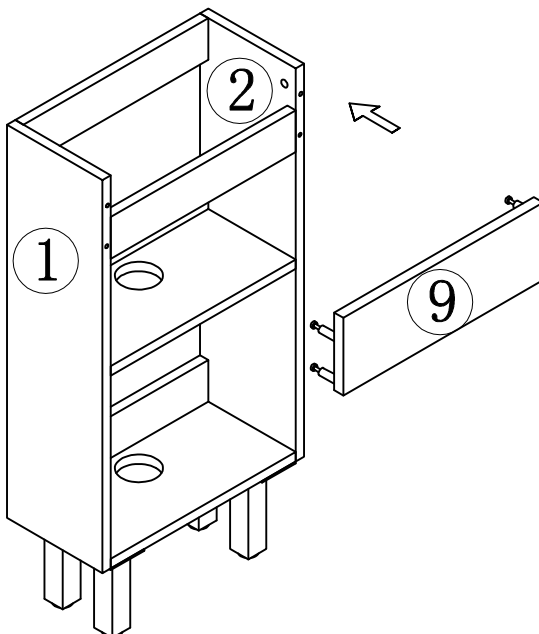

STEP 6

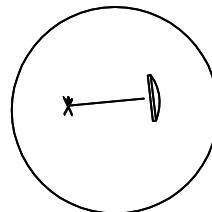

Install No.9 panels with the three-in-one eccentric wheel tightly.



Cover the mounting hole of the eccentric wheel with a three-in-one sticker.

| HARDWARE LIST | | |
|--|--|---|
| Three-in-one eccentric wheel | Three-in-one sticker |  |
| A  4PCS | C  4PCS | |

STEP 7

Install the door handle with 4*23mm screws.

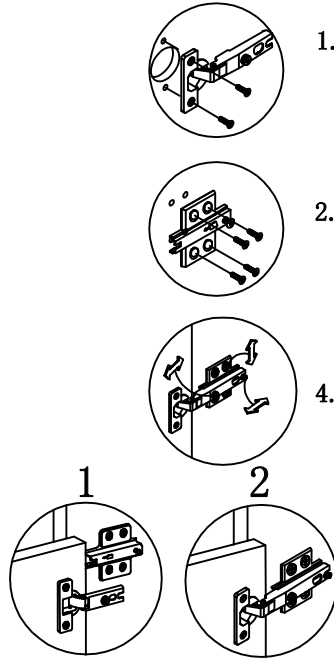
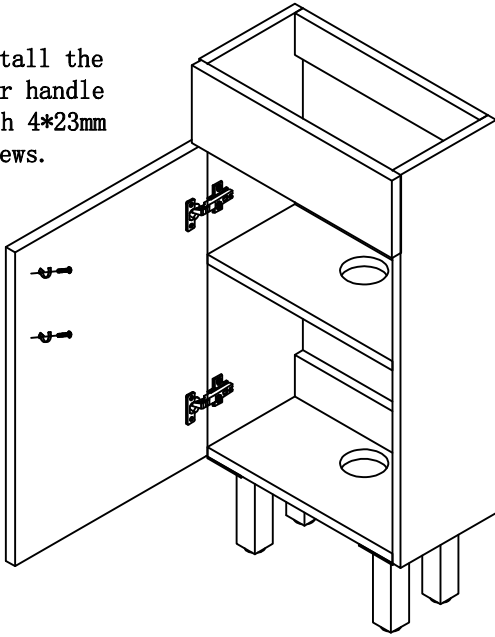

1. Install the hinge cup to the door panel with 4*16mm screws.

2. Install the hinge to the side panel with 4*16mm screws.

4. Adjust the door panel clearance.

3. Install the hinge cup on the door panel to the hinge of the side panel.

| HARDWARE LIST | | | | |
|--|---|---|---|--|
| 4*16mm screw | Door hinge | Door handle | 4*23mm screw |  |
| G  12PCS | E  2PCS | I  1PCS | H  2PCS | |

Hinge/Door Adjustment and Realignment

If adjustment or realignment is needed, follow the instructions provided in the following chart.

Vertical adjustment

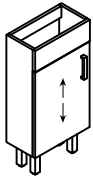

1. Loosen screws

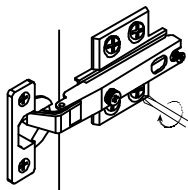

2. Adjust hinge

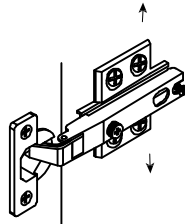

3. Tighten screws

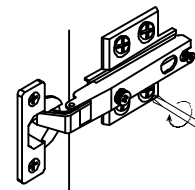

Horizontal adjustment

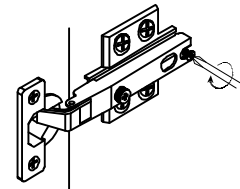
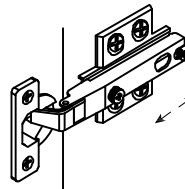
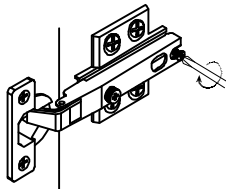
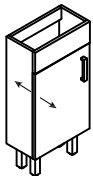

Door gap adjustment

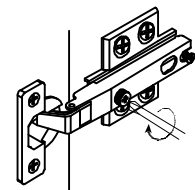
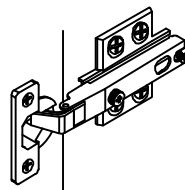
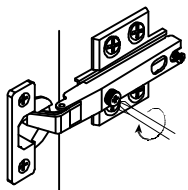
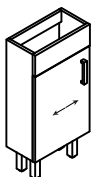



Choking hazard-Small Parts : This unit contains small parts, not for children under 3 years.

Tip-over hazard : Secure finished unit to wall stud using L-Bracket and wall screw (#10*1.5"W/out provided). If a wall stud is not neccessible , Consault your local hardware store for appropriate mounting hardware . Failure to properly install will result in product collapse or tip-over. Serious injury can occur .