

ASSEMBLY INSTRUCTION

10FT PRE-LIT WHITE PINE FULL-SIZE ARTIFICIAL CHRISTMAS TREE WITH 800 WARM WHITE LIGHTS, THREE FUNCTION

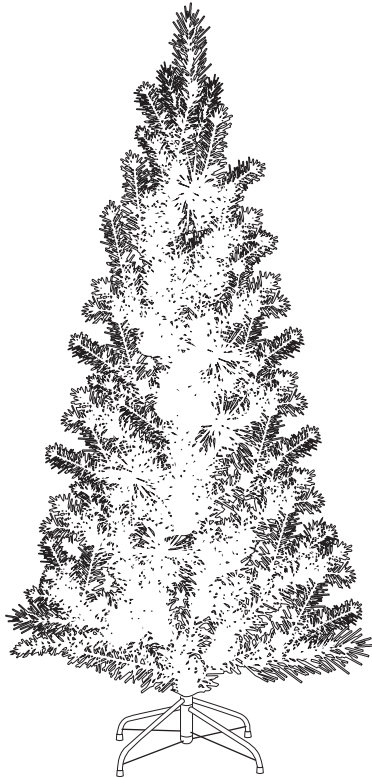

Please carefully unpack and identify each component before beginning assembly. Before you begin, please refer to parts list to make sure that you have all parts. Please take care when assembling the unit and always place the parts on a clean, soft surface. If you require assistance with assembly or parts, please call us.

BEFORE ASSEMBLING







1. Please check and make sure all the parts have been received.
2. Tools are not required for assembly.
3. The length of extension cord is 59 inch, please set up the tree in the suitable place away from the power socket.

CONTENT

Height	Number of tree parts	Stand
10'	4	Metal

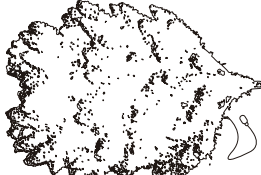
PART LIST

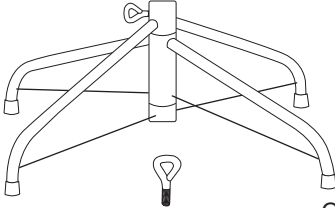
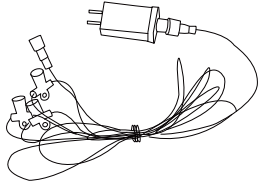
ATTENTION! THE PARTS OF THE TREE ARE DIVIDED INTO TWO PARCELS (A & B). PLEASE CHECK WITH PART LIST TO MAKE SURE ALL PARTS ARE RECEIVED.

<p>Tree Top (A)</p>  <p>QTY: 1</p>	<p>Upper Part (B)</p>  <p>QTY: 1</p>	<p>Middle Part (C)</p>  <p>QTY: 1</p>
<p>Lower Part (D)</p>  <p>QTY: 1</p>	<p>Stand & 1 Screws (E)</p>  <p>QTY: 1</p>	
<p>Power Line And Transformer (F)</p>  <p>QTY: 1</p>	<p>Remote Control (G)</p>  <p>QTY: 1</p>	

STEP-BY-STEP ASSEMBLY

PLEASE CAREFULLY UNPACK AND IDENTIFY EACH COMPONENT BEFORE BEGINNING ASSEMBLY. BEFORE YOU BEGIN, PLEASE REFER TO PARTS LIST TO MAKE SURE THAT YOU HAVE ALL PARTS.

- STEP 1** Assemble the stand on a stable surface.
Unfold the stand and insert the screw as indicated on Figure 1.

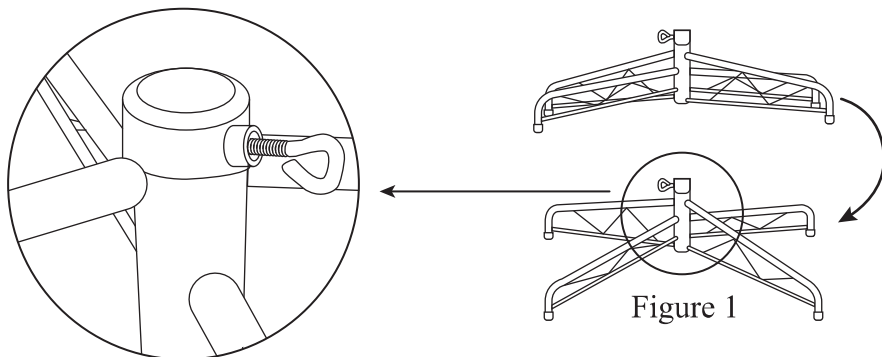

- STEP 2** Insert the trunk in the stand as indicated on Figure 2. When the trunk consists of more than one part, begin by inserting into the stand (Part E) the lower parts of the tree (Part D, Part C, Part B) in respective order, ending with the top (Part A).

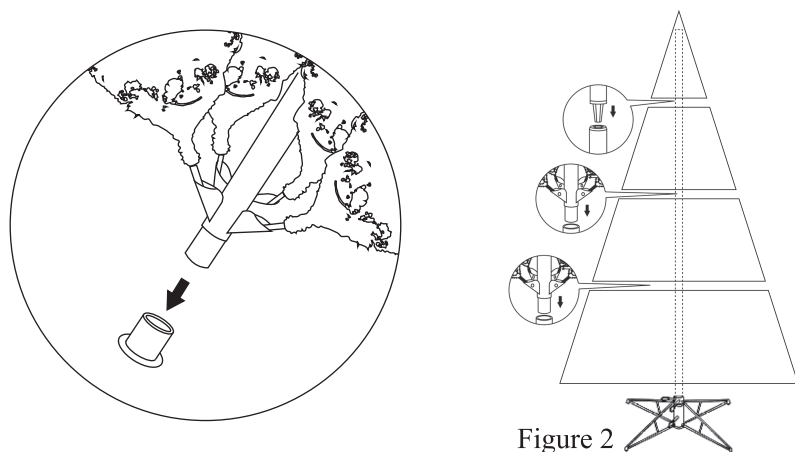

STEP 3 Unfold the branches one-by-one beginning with the lowest.

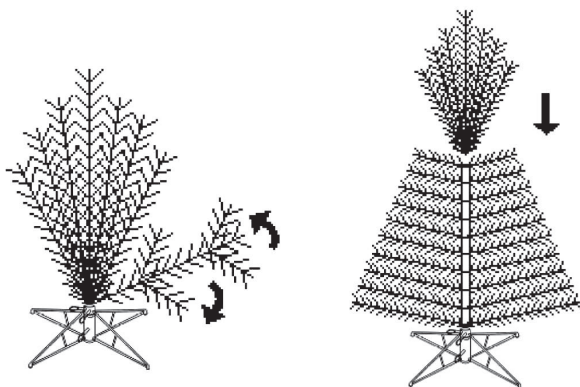

STEP 4 Make final adjustment for an elegant look.

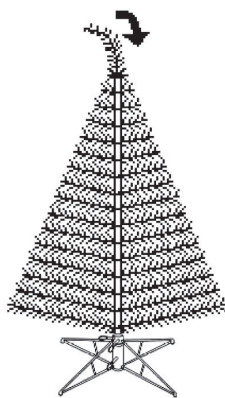

STEP 5 Connect the lights to power line (Part F).

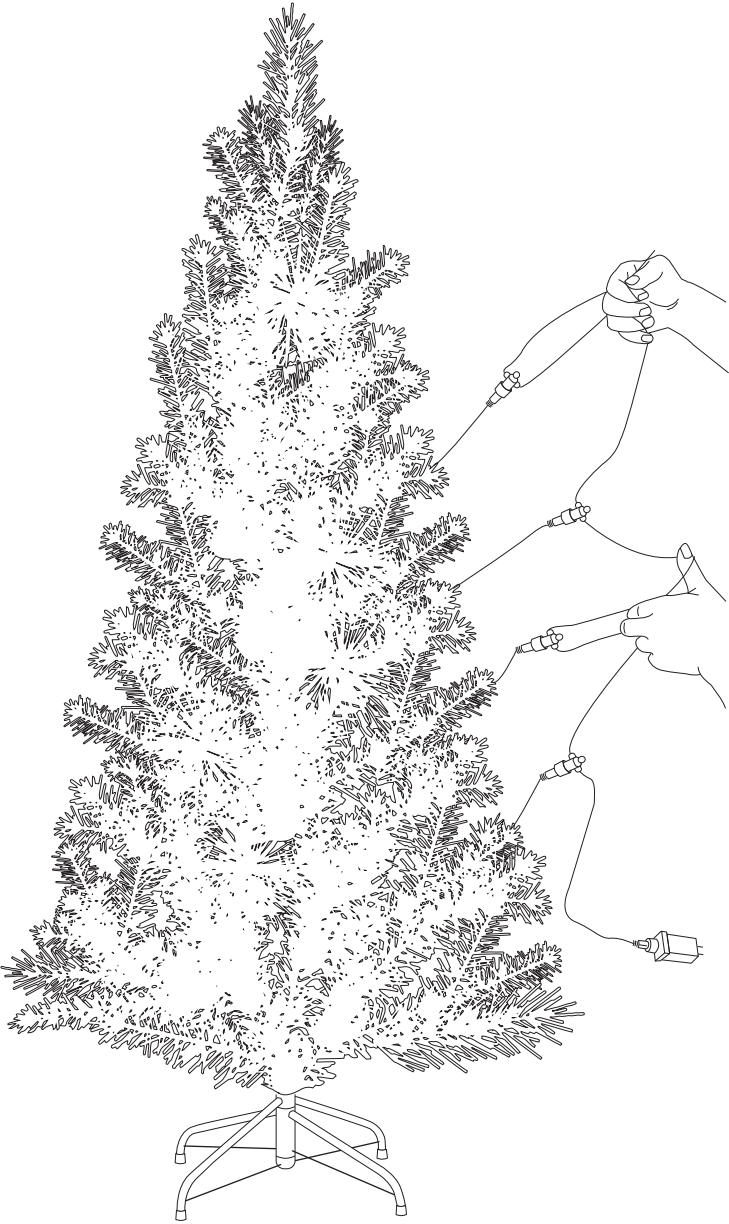

DISASSEMBLY AND STORAGE

1. Remove all decorations.
2. Disassemble the tree in reverse order of assembly.
3. Suggest to store the tree in its original carton box or in storage bag and keep in a cool dry place.

CAUTION

1. To be assembled by or under the supervision of an adult.
2. Keep plastic bags out of reach of children.
3. Keep away from fire or hot temperatures.
4. Do not light a candle on or near the tree.
5. Do not leave lighted electric cords unattended.
6. Do not overload with heavy ornaments and/or too many decorations.
7. Place the tree on an even surface to ensure stability.
8. This tree is intended for indoor use only.
9. Keep this information for future reference.

Made in China