

Installation Instructions

Knock-down Fiberglass Door Installation Instructions

Installation of fiberglass doors may not be suitable for all wall conditions across various regions. It is recommended to consult with your local building code official to ensure compliance with applicable building codes and regulations before starting installation.

Required Tools & Material



This document contains KHSHOW's recommended installation instructions for fiberglass knock-down doors. Prior to commencing installation, please carefully read these instructions. It is essential to acknowledge that not all door types are universally compatible with every wall condition, necessitating consultation with local building code officials to ensure adherence to applicable building codes and regulations. Not adhering to the instructions provided by the architect, design professional, or the manufacturer will directly impact the performance and long-term durability of this unit. The installer should have experience with similar installation work and be specialized in the required tasks for this project. Failure to meet these specifications may lead to the rejection of warranty claims.

Unpack the product

- Remove shipping materials (e.g. plastic covers, nails, staples, and screws)

Inspect the door

- Correct model (e.g., size, color, finish, glazing left/right handed etc.)
- Damage occurred during shipping
- Functionality of the door
- Flaws of the product (e.g. warp)

Please DO NOT install the door if any of the situations listed above raise your concern and contact us for further support.

Step 2: Inspect rough opening

Check those conditions:

- The rough opening (RO) is ideally 3/4" wider and taller than the door's height and width
- Ensure the RO is level, square and plumb.
- For retrofit installation please ensure the old door is removed completely. Also, make sure that the framing is still structurally complete and sound. The removed components should be disposed of or recycled properly.
- Proper precautions are required during installation if it is suspected that the existing paint contains lead. Please see www.epa.gov/lead for further information.
- Please ensure the sub-floor area is tidy, level, and dry.
- Please ensure the existing sub-floor is level. For 4-9/16" frame and deep for 6-9/16" frames)
- A sill pan flashing system may be used to ensure that water is blocked outside of the wall cavity. Please follow your flashing manufacturer's guidance.

Please make sure that the sub-floor is solid and level. As this step is critically important, do NOT move to the next step before a solid & level sub-floor is fully confirmed.

Step 3: Prepare door frame

- Gather the door jamb components and lay them on the floor
- Make the header & sill and align them with the jambs
- There are pre-drilled holes on each jamb, three on the top and two on the bottom. Align the header & sill with the jambs. Once aligned, use 2" screws to attach the header to the jambs and use 1 3/8" screws to attach the sill to the jambs. As you screw, ensure the components remain aligned and flush with each other.

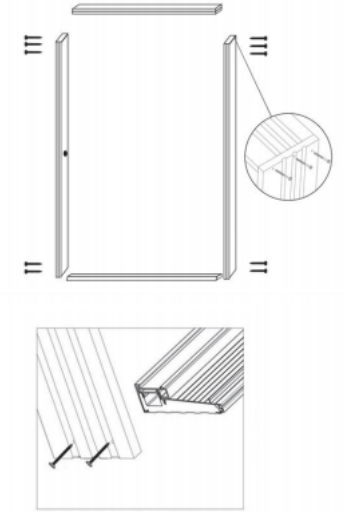

Knock-down Fiberglass Door

Step 4: Apply sealant

- Check the bottom of the door unit to ensure that it is flat.
- Certain threshold design may require the caulk be directly applied on the door unit.
- Prepare the sill floor by ensuring it's clean and free of debris.
- Using a caulking gun, apply three 3/8" beads of sealant along the entire length of the sill floor. **Make sure the beads are evenly spaced and run the entire length of the sill.**
- Additionally, extend each bead of sealant 2" up each side of the opening. This ensures a thorough seal and helps prevent any moisture or drafts from entering around the door trim.

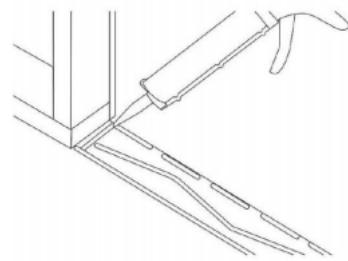

Step 5: Install door unit

- Place the assembled frame into the rough opening

Shimming

- When shimming the jambs, follow these steps: From the inside, place one shim on each bottom corner of the door unit. Shim at each hinge location and at the strike plate. Ensure the hinge jamb is plumb.
- Secure two 2-1/2" trim screws through each jamb and wall nearby the lower hinge position to temporarily hold the door unit. If the product includes two sidelites, place shims on the outside of the sidelites on the hinge side of the unit.

NOTE: DO NOT PLUMB AND SQUARE

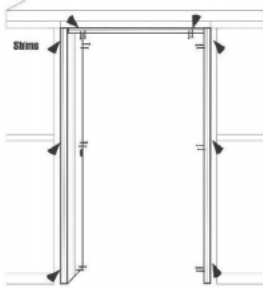

Before fastening the screws, please check:

- Verify that the door frame unit is plumb and level using a 4-foot level.

Installation of hinge jamb:

- Ensuring that the hinge side is plumb using a level, and screw and tighten 2-1/2" screws through every shim and jamb into the wall stud.

Note: If the jamb moves or twists when fastening the screws, the shim is not tight enough. Please loosen the screws and shim tighter, make sure the structure is firm enough and the gap is constant.

Installation of the latch jamb:

- Again, use a 4-foot level to plumb and square the latch side of the door. Screw and tighten 2-1/2" screws through every shim and jamb into the wall stud.
- Note: please check the gap is even for the latch side before tightening the 2-1/2" screws.

- After the installation, the dead bolt strike plate can be installed under the instructions of the manufacturer.

Step 6: Install the door slab

NOTE: For unfinished doors, it is recommended to finish the door following step 10 before installing the door slab.

- Mount the door onto hinges: position the door onto the hinges attached to the door jamb. Slide and tighten "screw through every hinge into the door slab.
- Check swing and adjust swing the door open and closed to check if the gaps are even on all sides. If adjustments are needed, use shims to make slight alterations until the door swing smoothly and the gaps are uniform.
- There are pre-drilled holes on the hinge routes. Make sure the edge of the hinges are fitted with the edge of the slab.

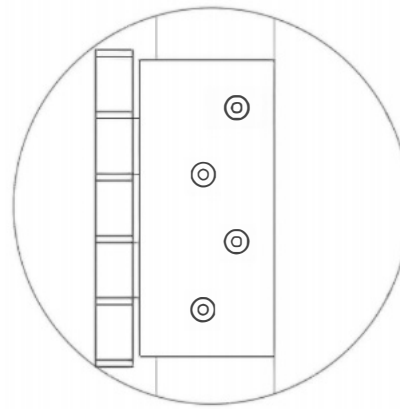

Step 7: Adjust sill

- You may want to adjust the sill for suitable height. You can use a screwdriver to raise or lower the sill by adjusting the sill screws.

- In ideal situations, after adjusting it is a bit hard to pull paper through the gap under the door when the door is closed, while the paper will not tear.

- If the paper gets stuck and gets torn, the sill will be too high. In contrast, if the paper can be easily pulled out, the sill is too low.

Ways to adjust:

- Turn the screw clockwise to reduce tension, counterclockwise to increase tension. It is advised to adjust a 1/2 turn each time and check the contact between the door sweep and threshold. Repeat this process if the position is not ideal. Some sills may have a cover. Please remove the cover when re-adjusting.

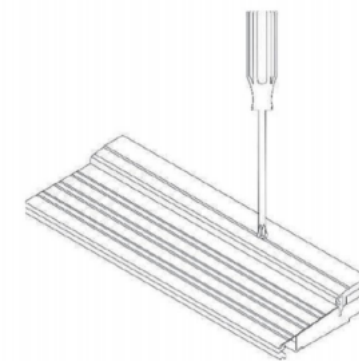

Step 8: Air seal

- After the shims are trimmed, use fiberglass insulation or low-pressure door installation foam to fill around the top and sides of the cavity between the jamb and wall studs. The depth of the foam is suggested to be between 1/2" to 1". (The figure shows an example of filling low pressure foam)
- After the insulation process, install the exterior/interior trim around the door.
- To create a continuous air seal and better insulation, the excess part of the shims need to be cut.

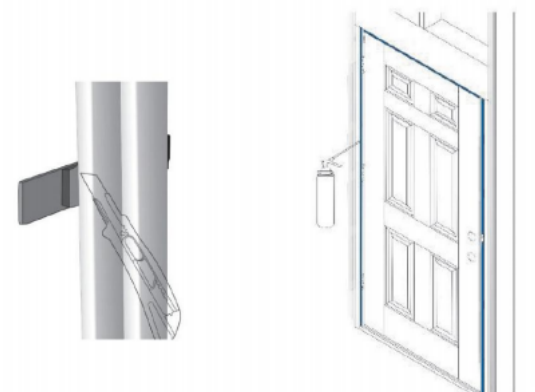

Step 9: Caulk doorway

- This step is to prevent moisture penetration and ensure a tight seal.
- Apply caulk around the four exterior corners of the doorway.
- Caulk is also required where the sill meets the jamb and slab to prevent water intrusion and air leakage.
- Caulk the edge of the rail cap on the exterior side.
- Caulk the top and bottom of the door unit and header (if the door unit contains a sidelite).

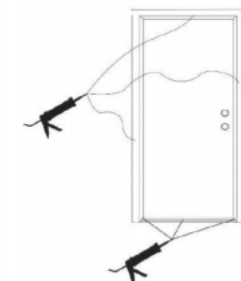

Step 10: Finishing the door

- Pre-finished door does not need any further finishing, skip this step.
 - All unfinished fiberglass doors need to be finished within one week after installation.
 - Avoid subjecting your door or sidelite to extreme conditions such as heat, cold, moisture, and humidity.
 - You can either stain or paint the door.
- Staining: immerse stain into the door surface, so that the woodgrain texture can be reserved mostly.
- Painting: put another layer of paint on the door surface, which will cover the texture above.

Follow the steps in 10.1 for staining or steps in 10.2 for painting.

Step 10.1: Staining the door

Working area requirement:

- Clean, dry, and dust-free
- Good ventilation
- Any condition instructed by the stain supplier

SAFETY FIRST

Before starting, please prepare and equip safety glasses, respirator, and protective gloves.

Materials needed:

1. Mineral spirit/Acetone
2. Two clean lint-free cotton rags or cheese cloth
3. 2" Foam brush
4. Painter's tape (Masking tape)
5. Paper towel
6. Sanding paper & block
7. Safety utility blades
8. Stir sticks
9. 2-1/2" wide China bristle brush
10. Exterior grade Topcoat (All exterior coats must have ultraviolet (UV) inhibitors)
11. Stain (oil-based is preferred), Please consult the stain supplier for recommendation of suitable stain

10

Step 10.2: Painting the door

Working area requirement:

- Clean, dry, and dust-free
- Good ventilation
- Any condition instructed by the paint supplier

SAFETY FIRST

Before starting, please prepare and equip safety glasses, respirator, and protective gloves.

Materials needed:

1. Mineral spirit/Acetone
2. Mild cleaner (Soapy water)
3. Painter's tape (Masking tape)
4. Paper towel
5. Sanding paper & block
6. Safety utility blades
7. Stir sticks
8. Paint
9. 2-1/2" wide bristle brush (Natural bristle brush for oil-based paint, synthetic bristle brush for water-based paint)

Choose the type of paint:

- Lacquer is not recommended for exterior use.
- Oil-based paint is prohibited in certain states, please check the local code of law for painting.
- Fiberglass door with dark color may absorb heat quickly and be hot under sunlight. Please take this into consideration when choosing paint.

Other tools:

- Screwdrivers
- Sprayer (if any)

Please read the instructions carefully before starting the painting process.

Prepare the surface

15

Step 10.1: Staining the door

Other tools:

- Screwdrivers

Please read the constructions carefully before starting the stain process.

Prepare the surface

The door slab can be finished while hanging or before installation. We recommend you to finish the door before installation. If you have installed the door slab and want to detach it, please use a screwdriver to remove the hinge. Be careful not to damage the door during operation. The sidestile needs to be stained vertically.

To remove excess glazing sealant, first spray the area with window cleaner or water. Then, using a safety utility blade, carefully scrape the glazing sealant from the glass. Hold the blade at a 45-degree angle and work along the edge of the frame. Use paper towels to wipe out the water after cleaning and make it dry.

To avoid dust attachment on the surface and achieve the best stain adhesion, clean all surface/sides of the unit with mineral spirits/acetone/ all-purpose cleaners. Allow it to dry before staining.

Mask off anything that will not be finished using painter's tape, such as the glass insert.

Caution:

Do not sand fiberglass.

Prepare the stain

Choose high quality stain (oil-based preferred). Stir the stain well and keep it creamy (no bubble), repeating this throughout the process. Before starting, it is suggested to test the effect on a small piece of panel with similar material to the door or on an inconspicuous place of the door/frame.

Recommended staining sequence: (Shown in the picture)

11

Step 10.1: Staining the door

1. Panels
2. Mullions
3. Rails
4. Stiles
5. Edge & sides

(Frame could be stained separately)

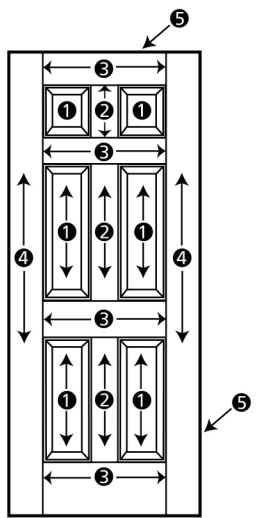

First coating

- Make sure to put safety glasses, respirator, and protective gloves on before staining.
- Immerse the end of the foam brush into the stain and then use the container's rim to remove surplus.

Caution: Do not overload the brush to improve operating preciseness, avoid spilling of the stain to unintended area.

Place the stain on the desired section of the door. To better embed pigment into woodgrain, use a cloth to meticulously rub the stain into the embossed woodgrain in circular motion.

- Apply this process separately for each section and clean the perimeter of each section using rag & Mineral spirit/Acetone to make the edge between each section more apparent.

12

Step 10.2: Painting the door

- Immerse the end of the bristle brush into the paint and then use the container's rim to remove surplus.
- Caution: Do not overload the bristle brush to improve operating preciseness, avoid spilling of the paint to unintended area.

- Brush each section of the door evenly following the order below:

1. Panels
2. Mullions
3. Rails
4. Stiles
5. Edge & sides
6. Frame

Note: For a better appearance, brush along the grain direction as much as possible.

Painting with sprayer

- Adhere to the manufacturer's guidelines for diluting the paint. Strain the paint before loading it into the sprayer. To ensure that the paint lays on the surface evenly, spray the paint continuously across the door. It is suggested to spray beyond the edge of the door, to ensure all sides are covered. Spray slightly and repeat it multiple times, to avoid unintended heavy coat.
- All six sides of the door need to be sealed. Incomplete painting may fail to prevent environmental jeopardy and wear the door fast. Failure to seal six sides may void the warranty.

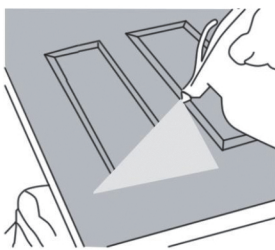

After painting

Wait until the paint is fully dry. The time will depend on the product and weather. Please follow the paint suppliers' instructions. The paint may run during drying, and this effect could be minimized by laying down the door on a level place.

If you want to apply a second coat, please also do that after the first coat is completely dry.

Important Tips:

1. Unfinished doors are vulnerable and can be ruined by a rainy day. Finish the door and jamb immediately after installation or before exposure. Failure to follow this instruction will void the

16

Step 10.1: Staining the door

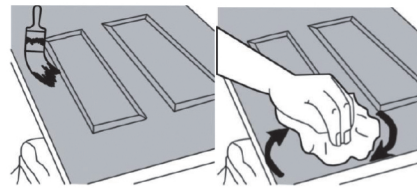

- Use a lint-free cotton rag or Cheesecloth to gently wipe the stain if you want the darkness of the stain variate slightly across the section. NOTE: Be very gentle when you wipe, do not wipe too much stain.

- To finally tidy up the stain, using a China bristle brush to brush the area with same intended color, to spread the stain evenly and show a consistent appearance. Please note those steps need to be finished while the stain is still wet. It is best to proceed continuously.
- Once the color spreads nicely in an expected way, the first stain process is finished. Please wait until the stain gets completely dry to move on. (The time needed for drying is per the instruction of the stain supplier, which may vary from different product. Make sure to confirm before starting the next step)
- You can still stain again by repeating the process above after the first stain is completely dry if you want a darker surface. The more stain is used, the darker the appearance.

Caution:

Do not sand between coats.

Top coating:

Cautions:

1. Use high quality, exterior grade coat with ultraviolet (UV) inhibitors.
 2. Allow the first layer of stain to dry completely. (Suggest at least 48 hours, specific time please refer to the stain supplier's instruction)
 3. Exterior grade, high-performance topcoat is important to help durability and washability of the door.
 4. All six sides of the door need to be sealed. Incomplete coating may fail to prevent environmental jeopardy and wear the door fast. Failure to seal six sides may void the warranty.
- Start top coating:**
- Complete protection of the door at least needs TWO Layers of topcoat.
 - As a similar preparation with the first staining, gently stir the topcoat and keep it wet during the whole process.
 - Immerse the end of the foam brush into the topcoat and then use the container's rim to remove surplus.
- Caution: Do not overload the brush to improve operating preciseness, avoid spilling the topcoat to unintended area.
- Apply the topcoat gently, slide through the panel two to three times quickly to ensure the coat covers the surface evenly and completely. Make sure do not overbrush the first layer, a thin

13

Step 10.2: Painting the door

warranty.

2. It would be better to choose finishing products from the same supplier.
3. For some prehung doors, the bottom edge of the door is pre-sealed.
4. Keep the materials away from children. Dispose the waste and recycle the materials per the local laws.

Care

1. If the door surface is slightly damaged after finishing, you can sand that area slightly and re-finish it again.
2. To sustain the finish for a longer period, it is better to clean the door frequently. (Always make it dry after cleaning)
3. The finish will wear over time, it is suggested to repaint the door each year.
4. Keep the paint away from flame and heat as much as possible.

Step 11: Install corner seal

- The corner seal can tighten up the bottom edge and block dust and pests.
- Caulk the corner where the cap sill interacts with the jamb.
- Stick the corner seal firmly on the corner, make sure the thick side sits with the weatherstrip, and the caulk covers the bottom edge of the pad completely.

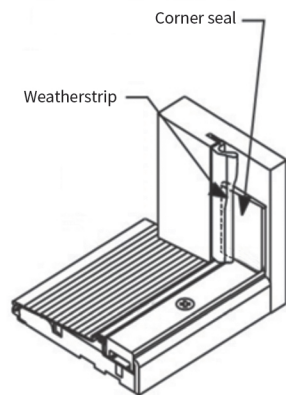

18

Step 10.1: Staining the door

first coat is appropriate.

- Wait until the first topcoat is completely dry. Suggested time is 3 – 5 hours (please refer to the instruction of coat supplier)
- After confirming the dry surface, apply a second layer of coat by repeating the process above. A second coat is necessary to fully protect the door, and it should be re-coated annually.
- After finishing 6 sides of the door, ensure it is completely dry and remove the tape used before staining. Clean the unit and install it back on the frame.

Important Tips:

1. Unfinished doors are vulnerable and can be ruined by a rainy day. Finish the door and jamb immediately after installation or before exposure. Failure to follow this instruction will void the warranty.
2. It would be better to choose finishing products from the same supplier.
3. For some prehung doors, the bottom edge of the door is pre-sealed.
4. Keep the materials away from children. Dispose the waste and recycle the materials per the local laws.

Care

1. If the door surface is slightly damaged after finishing, you can sand that area slightly and re-finish it again.
2. To sustain the finish for a longer period, it is better to clean the door frequently. (Always make it dry after cleaning)
3. The finish will wear over time, it is suggested to re-seal the door each year.
4. Keep the stain and coat away from flame and heat as much as possible.

14

Step 12: Install the hardware

- Install the strike plate, lockset, and deadbolt at the right position per supplier's instruction.
- Please note specific lockset model may be required for coastal areas. Please check further information on www.tdi.texas.gov & www.floridabuilding.org.

Step 13: Performance check

- After finishing installation, please check if the door works smoothly.

- If not, please check those points:

1. The RO is large enough for the door unit.
2. The door is level, plumb, and square.
3. The gap between the top edge of door panel and frame is consistent.
4. The weatherstrip fits well on the jamb.
5. The shims are correctly installed, and the two jambs are paralleled.

19