

# Assembly Instructions

Item #:FUR2025017

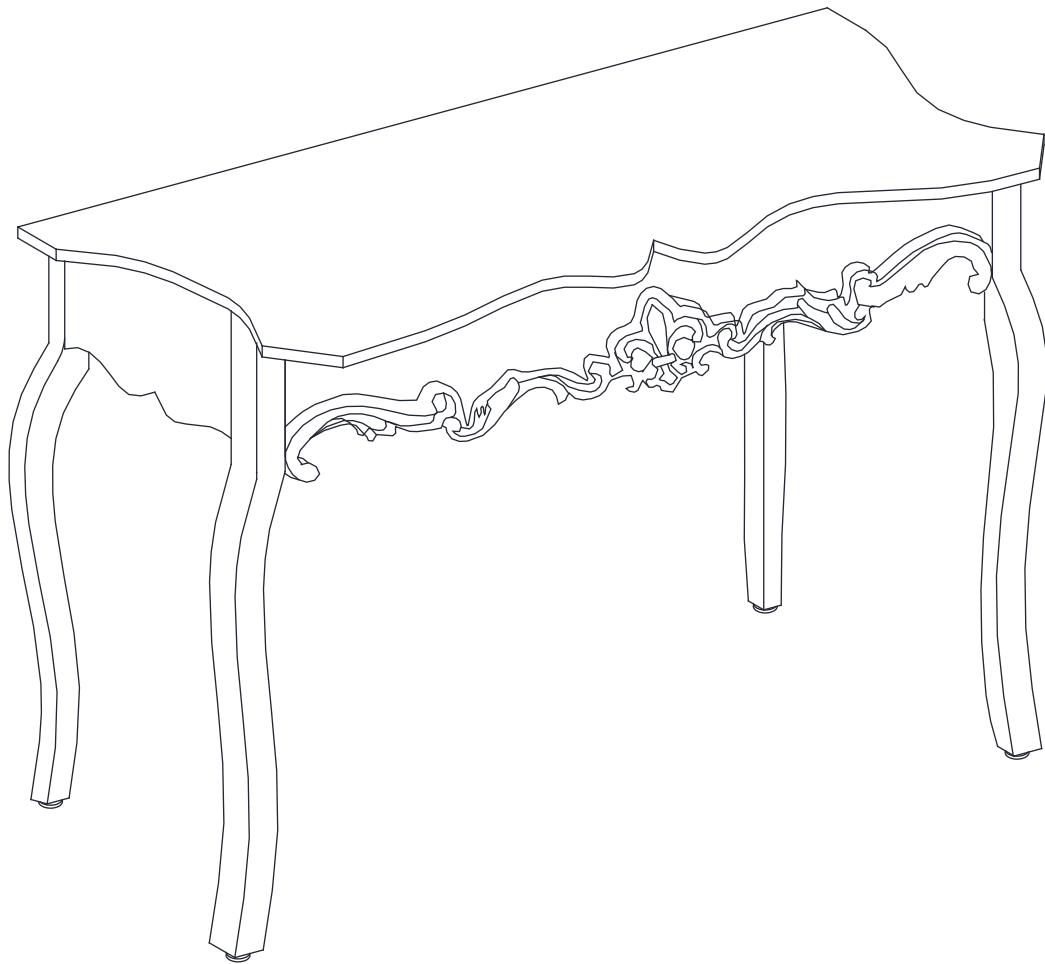

# Exploded Drawing

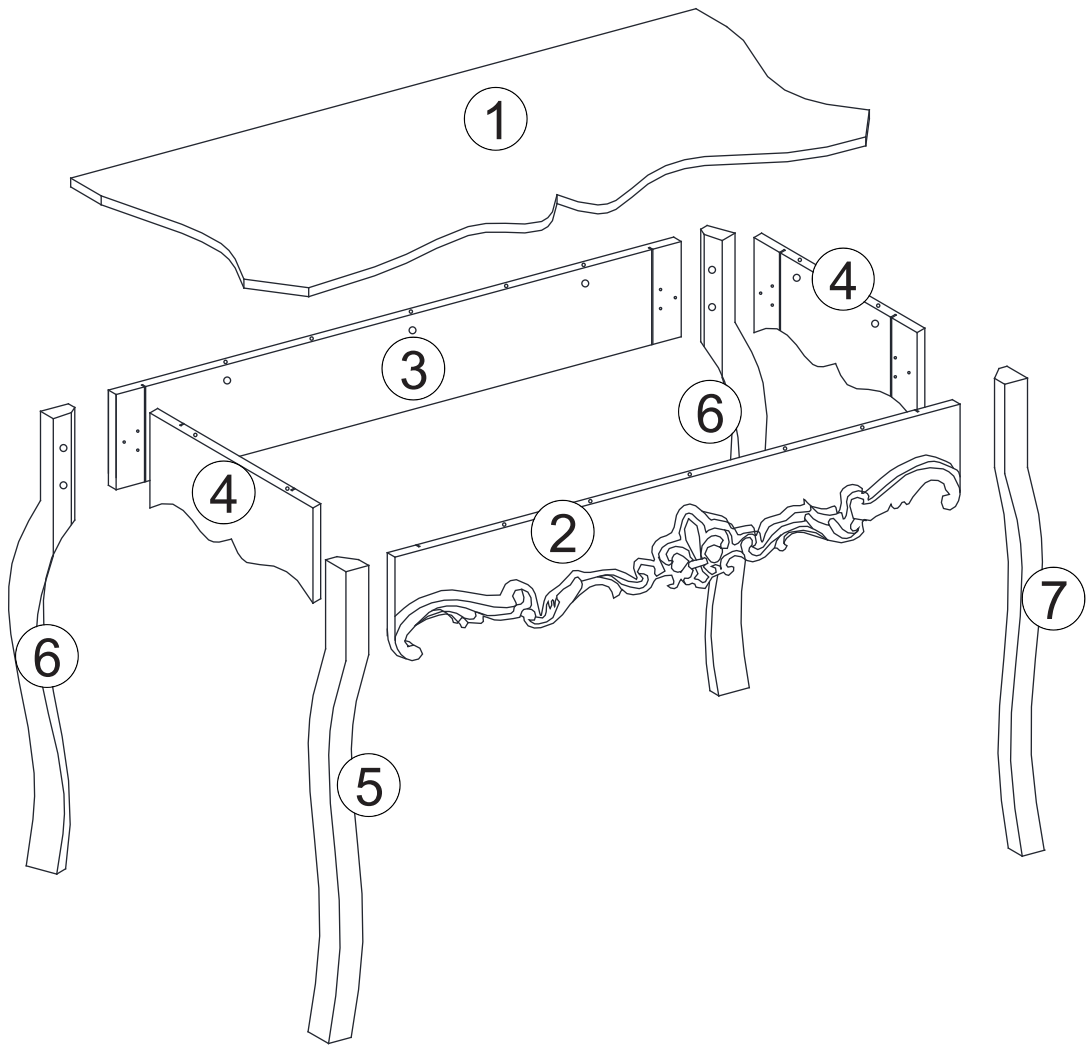

# Parts

① 1PC

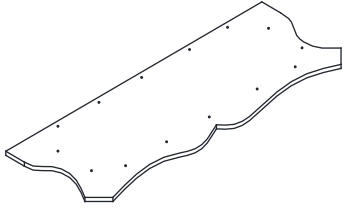

② 1PC

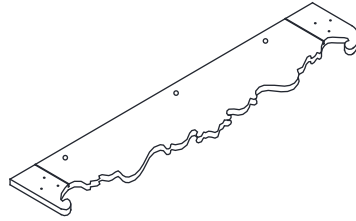

③ 1PC

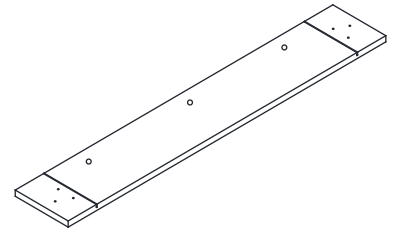

④ 2PCS

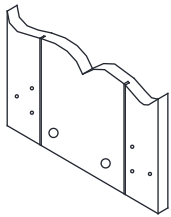

⑤ 1PC

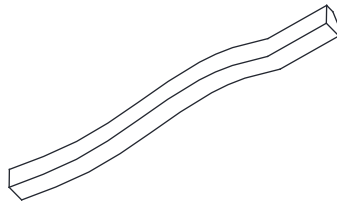

⑥ 2PCS

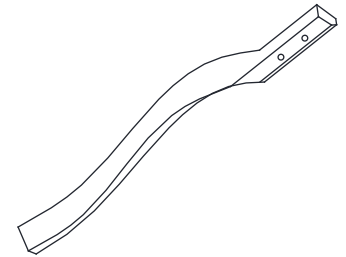

⑦ 1PC

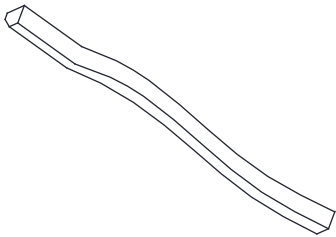

# Parts

A



10 PCS  
+1(spare)

B



10 PCS  
+1(spare)

C

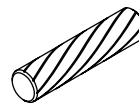

4 PCS

D

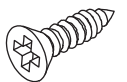

24 PCS  
+1(spare)

E

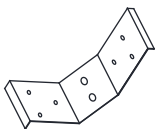

4 PCS

F

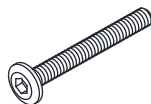

8 PCS

G

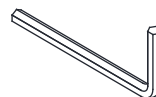

1 PC

H

# ASSEMBLY TOOLS REQUIRED (NOT INCLUDED)

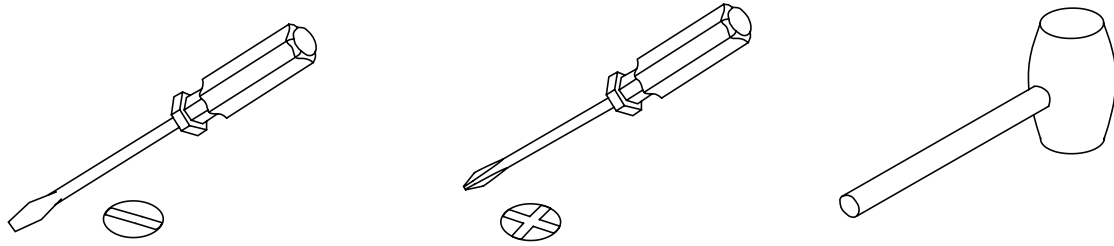

- \* Before discarding packing materials, please check all parts and hardware are presented.
- \* Please follow the instructions closely.
- \* After few days of initial assembly, the product may have acclimated to new environment, please tighten all hardware again.

## Dowel Installation

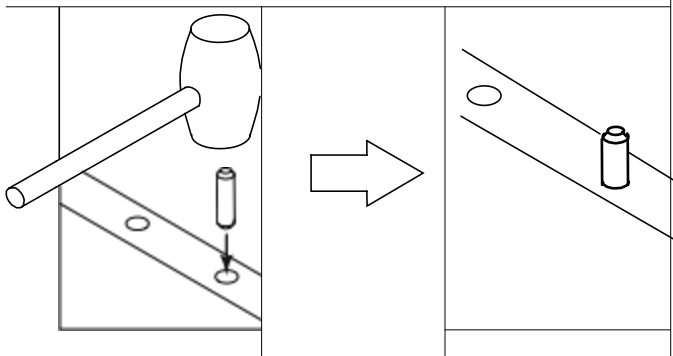

Gently tap dowel into hole with rubber mallet.

## CAM-LOCK

Tighten until shoulder is flush with panel. Do not overtighten or undertighten

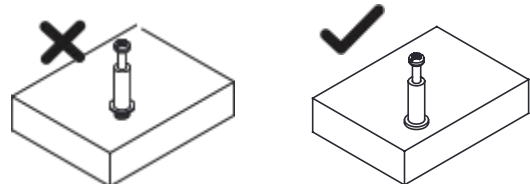

## WHEN FITTING CAMS

ENSURE STARTING POSITION IS CORRECT  
BEFORE YOU INSERT CONNECTING CAM-PILLAR  
TURN CLOCKWISE UNTIL SECURE

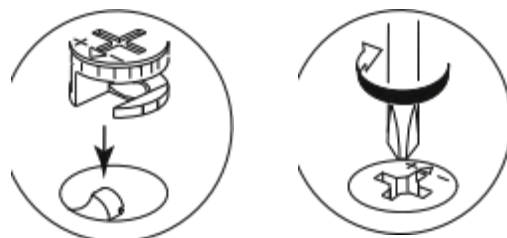
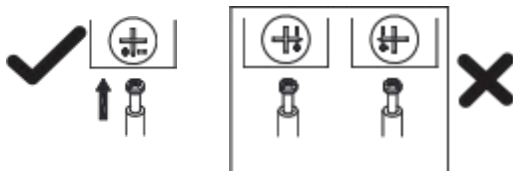

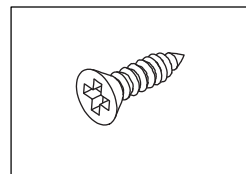
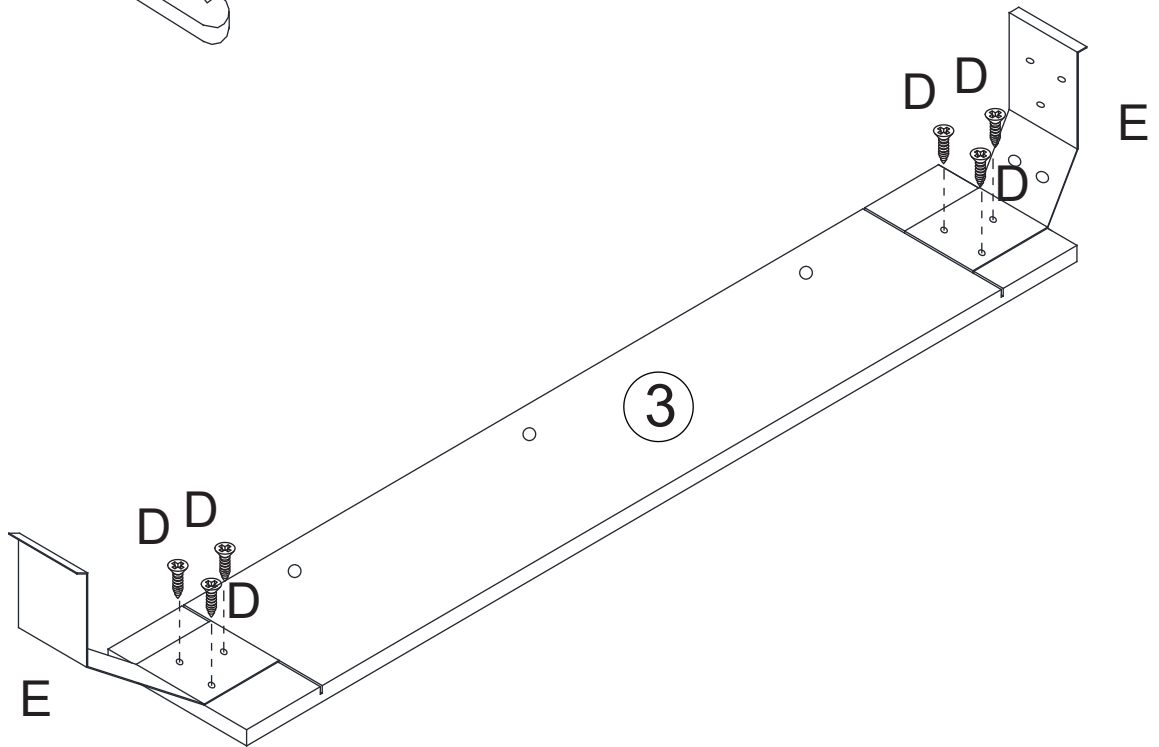
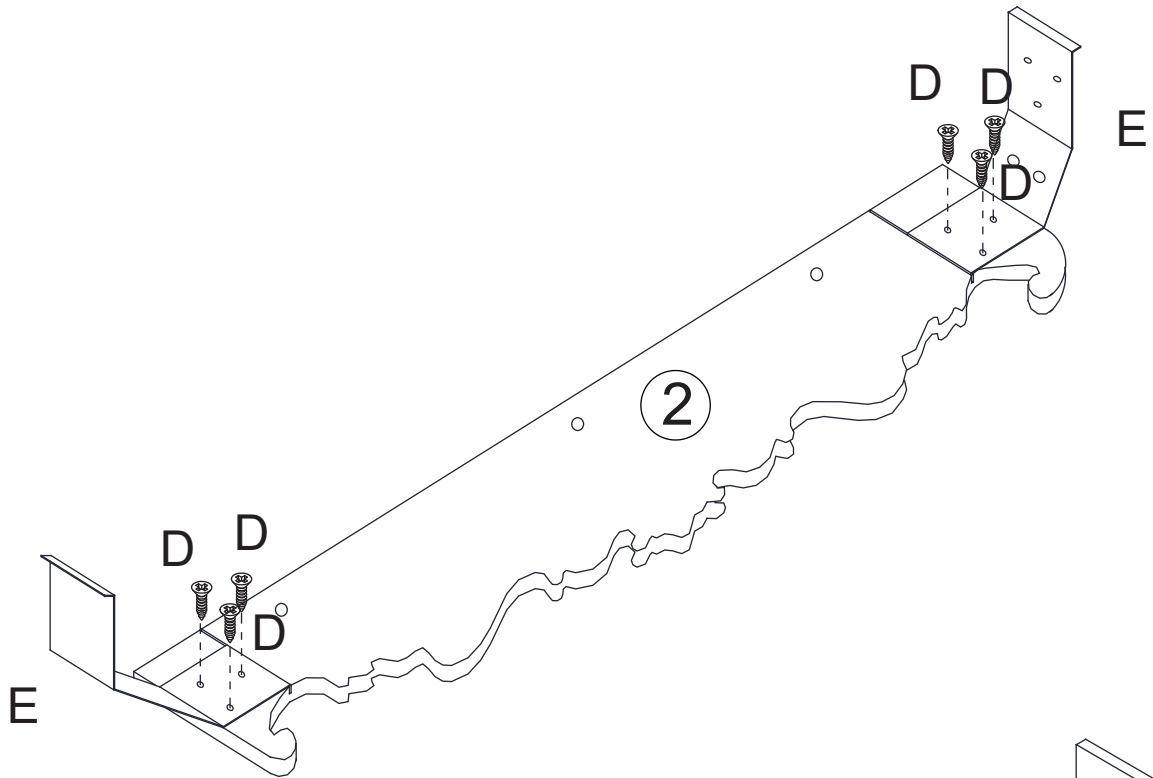

D x12

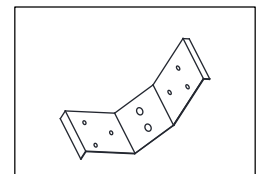

E x4

Note: please pay attention to the orientation of the curve edges on panel #4.

