

Revised  
English

# Curios and Consoles

**SOME INSTRUCTIONS AND / OR PARTS MAY NOT APPLY TO YOUR PARTICULAR MODEL**

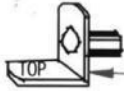

**GLASS SHELF SUPPORT:** insert its pin into the hole at wood frame inside the curio; Extra holes are provided so that you can adjust glass shelf height at your desired location.

NOTE: BEFORE INSTALLING THE GLASS SHELVES, WE RECOMMEND THAT YOU SECURE THE UNIT TO THE WALL AFTER POSITIONING THE UNIT IN THE DESIRED LOCATION.  
ON ALL CURIOS: THE ATTACHED WALL HANGING BRACKET(S) WILL ALLOW THE UNIT TO BE SECURED TO THE WALL, AND WILL HELP PREVENT TIPPING OF THE UNIT.

NOTE:

SOME CURIOS HAVE THE DOOR HARDWARE SHIPPED OFF THE UNIT AND PLACED IN A BAG INSIDE FOR SHIPPING PURPOSES AND MUST BE INSTALLED BY THE CUSTOMER.

TO INSTALL: ALIGN HARDWARE ON THE OUTSIDE OF DOOR THEN USE A STANDARD SCREWDRIVER TO TIGHTEN UP THE ENCLOSED SCREWS.

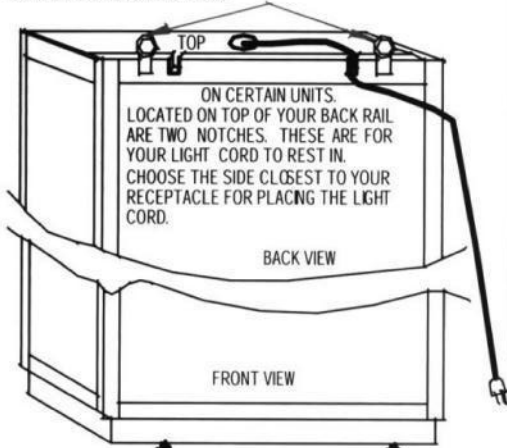

ON CERTAIN UNITS, LOCATED ON TOP OF YOUR BACK RAIL ARE TWO NOTCHES. THESE ARE FOR YOUR LIGHT CORD TO REST IN. CHOOSE THE SIDE CLOSEST TO YOUR RECEPTACLE FOR PLACING THE LIGHT CORD.

BACK VIEW

FRONT VIEW

NOTE: USE ADJUSTABLE GLIDES TO LEVEL DOORS AFTER SET-UP. ALIGN SLIDING DOORS BY TURNING GLIDES UP OR DOWN UNTIL DOORS ARE LEVEL AT THE TOP AND BOTTOM. ALSO USE TO LEVEL UNIT ON UNEVEN FLOORS.

Some lights are controlled by an On / Off switch that is located on the cord. Roll the wheel forward to turn the light On or Off. Some lights are controlled with this switch that has High, Low, and Off settings.

The holder can be taped to the left or right back of the Curio.



NOTE: IF DOORS ARE OUT OF SQUARE AFTER SHIPPING OR DO NOT SLIDE PROPERLY, LEVEL CURIO USING LEVELING INSTRUCTIONS.

NOTE: FOR SLIDING DOORS, THE DOORS ON YOUR UNIT SLIDE MORE EASILY WHEN PUSHED/ PULLED FROM THE CENTER OR A SLIGHTLY BELOW.

NOTE: IF YOUR CURIO IS EQUIPPED WITH A LOCK ON THE DOOR, THE KEYS ARE TAPED TO THE OUTSIDE OF THE CASE.

REMOVE RUBBER BANDS FROM LIGHT FIXTURE AND TWIST-TIE WIRE FROM AROUND POWER CORD. RUN CORD THROUGH EXIT HOLE IN FURNITURE AND INSTALL ENCLOSED HOLE PLUG INSIDE THE UNIT.

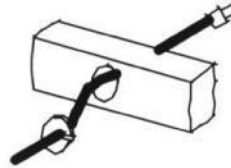

NOTE: IF YOUR NEW UNIT IS EQUIPPED WITH ELECTRICAL OUTLETS ON THE BACK UPRIGHT RAILS, INSIDE THE CASE. IF ANY OF THE OUTLETS DO NOT FUNCTION PROPERLY AFTER SHIPMENT, PLEASE CHECK THE CONNECTIONS BETWEEN THE OUTLETS FOR TIGHTNESS. THEY ARE LOCATED ON THE BACK OF THE CASE.

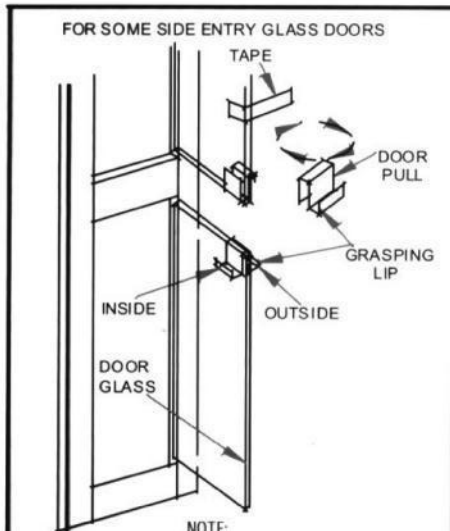

FOR SOME SIDE ENTRY GLASS DOORS

TAPE

DOOR PULL

GRASPING LIP

INSIDE

OUTSIDE

DOOR GLASS

NOTE:

THE DOOR PULLS ARE SHIPPED REVERSED (TURNED TO THE INSIDE)

TO OPEN DOORS PULL THE TAPE THAT IS ATTACHED TO THE TOP DOOR AND OPEN. REACH INSIDE AND PUSH BOTTOM DOOR OPEN.

AFTER THE DOORS ARE OPEN REMOVE THE BRASS PULLS FROM THE GLASS DOORS AND ROTATE THEM SO THAT THE GRASPING LIP IS FACING TO THE OUTSIDE (AS SHOWN ABOVE) THEN REPLACE ON THE DOORS.

UPON COMPLETION, REMOVE TAPE FROM DOOR.

NOTE: BEFORE PLUGGING YOUR POWER CORD INTO THE ELECTRICAL SUPPLY, REMOVE THE END CAP OF THE LIGHT FIXTURE BY PRESSING THE TWO BOTTOM FLANGES TOWARD EACH OTHER UNTIL THE END CAP CAN BE PULLED OUT, AS SHOWN. THEN REMOVE CARDBOARD PROTECTOR FROM THE BULB. THE END CAP CAN BE REPLACED BY AGAIN PRESSING THE FLANGES TOGETHER UNTIL THE CAP FITS OVER THE SHIELD. TO CHANGE THE LIGHT BULB, FOLLOW THE SAME PROCEDURE AS ABOVE TO REMOVE AND REPLACE THE END CAP.

NOTE: LIGHT IS CONTROLLED BY A TURN SWITCH ON FIXTURE

## IMPORTANT LIGHT INSTRUCTIONS FOR CERTAIN UNITS.

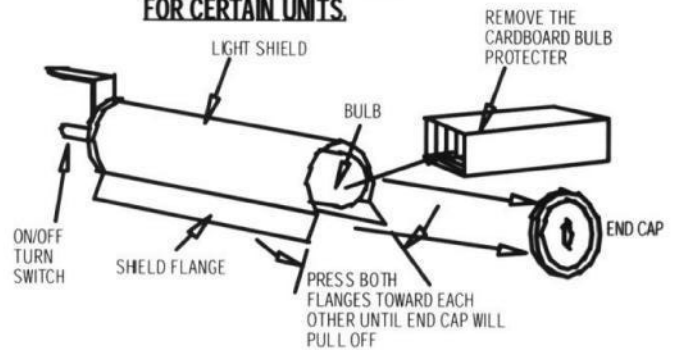

REMOVE THE CARDBOARD BULB PROTECTOR

ON/OFF TURN SWITCH

SHIELD FLANGE

PRESS BOTH FLANGES TOWARD EACH OTHER UNTIL END CAP WILL PULL OFF

END CAP

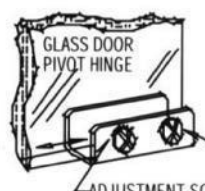

ADJUSTMENT SCREWS

IF THE UNIT HAS GLASS DOORS, THEY CAN BE ADJUSTED OR REMOVED BY LOOSENING ADJUSTMENT SCREWS ON HINGE. (CAUTION: DO NOT OVERTIGHTEN)

## GLASS SHELF REMOVAL INSTRUCTIONS FOR CURIOS WITH GLASS SHELVES SHIPPED INSIDE

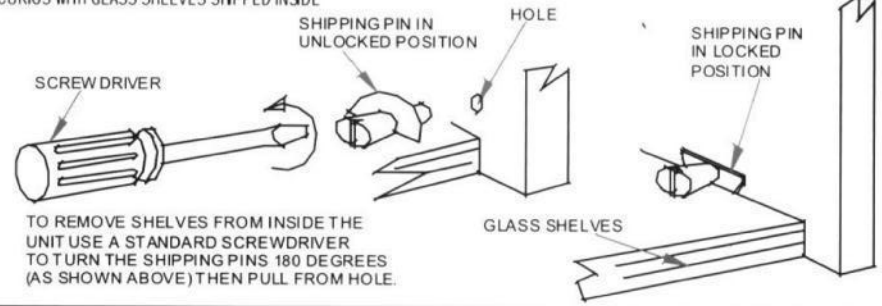

SCREWDRIVER

SHIPPING PIN IN UNLOCKED POSITION

HOLE

SHIPPING PIN IN LOCKED POSITION

TO REMOVE SHELVES FROM INSIDE THE UNIT USE A STANDARD SCREWDRIVER TO TURN THE SHIPPING PINS 180 DEGREES (AS SHOWN ABOVE) THEN PULL FROM HOLE.

GLASS SHELVES

**WARNING:** The canister light gets hot. Do not place anything on top of the canister light.

The intended use of this furnishing is for indoor household furniture.

Avoid contact with the cord prongs.

Avoid contact of combustibles such as plastic, paper goods, and similar materials with the lamp, lamp holder and reflector.

The luminaire is not intended for illumination of aquariums.

**IMPORTANT SAFETY INSTRUCTIONS**

When using an electrical furnishing, basic precautions should always be followed, including the following:

Read all instructions before using this furnishing.

**DANGER** — To reduce the risk of electric shock:

1. Always unplug this furnishing from the electrical outlet before cleaning.

**WARNING** — To reduce the risk of burns, fire, electric shock, or injury to persons:

1. Unplug from outlet before putting on or taking off parts.

2. Close supervision is necessary when this furnishing is used by, or near children, invalids, or disabled persons.

3. Use this furnishing only for its intended use as described in these instructions. Do not use attachments not recommended by the manufacturer.

4. Never operate this furnishing if it has a damaged cord or plug, if it is not working properly, if it has been dropped or damaged, or dropped into water. Return the furnishing to a service center for examination and repair.

5. Keep the cord away from heated surfaces.

6. Never operate the furnishing with the air opening blocked. Keep the air openings free of lint, hair, and the like.

7. Never drop or insert any object into any opening.

8. Do not use outdoors.

9. Do not operate where aerosol (spray) products are being used or where oxygen is being administered.

10. To disconnect, turn all controls to the off position, then remove plug from outlet.

11. For loading, always put heavier items at the bottom and not near the top in order to help prevent the possibility of the furnishing tipping over.

12. **WARNING** — Risk of Injury to Persons – do not place video equipment such as televisions or computer monitors on shelves.

13. **WARNING** — Risk of Injury to Persons – do not use this furnishing to support video equipment such as televisions or computer monitors.

SAVE THESE INSTRUCTIONS

**WARNING - 25 pounds MAXIMUM weight per shelf!**