

43226

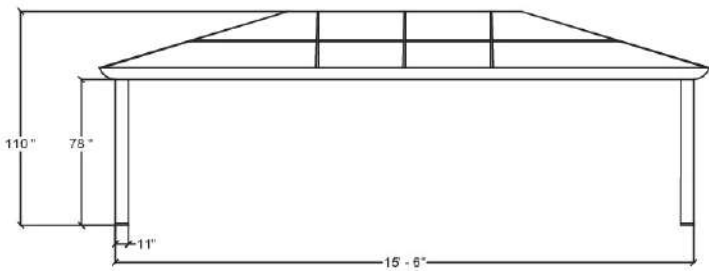

VUE DE CÔTÉ (LONGUEUR)
SIDE VIEW (LENGTH)

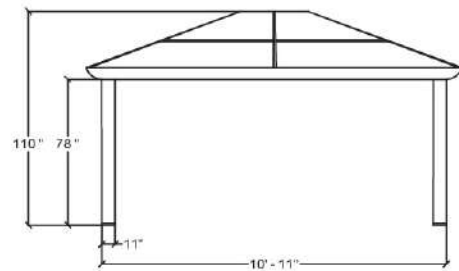

VUE DE CÔTÉ (LARGEUR)
SIDE VIEW (WIDTH)

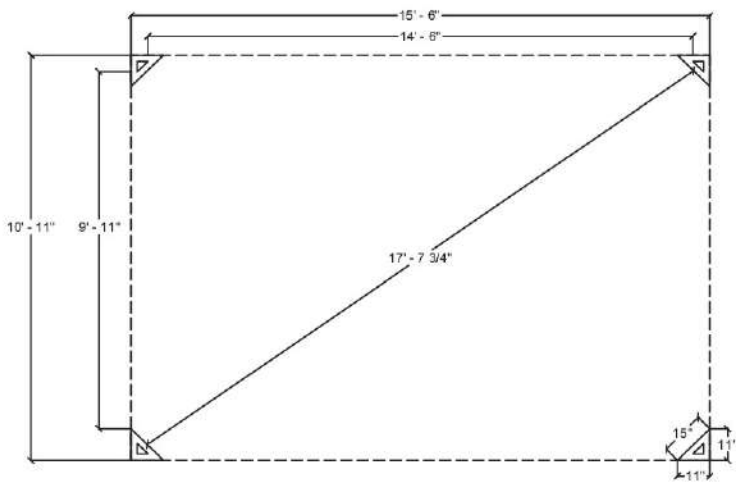

PLAN A LA BASE DES PATTES
PLAN AT THE BASE OF THE LEGS

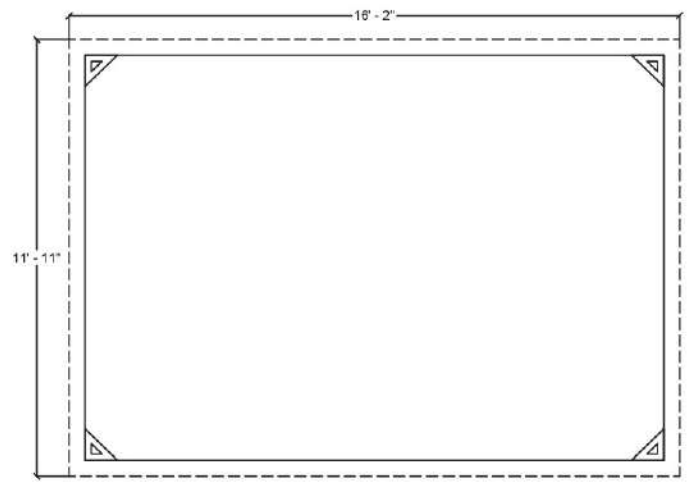

REBORD DU TOIT
ROOF OVERHANG