

INSTRUCTION MANUAL



IMPORTANT WARRANTY INFORMATION

PLEASE READ CAREFULLY

If you have any problems or dissatisfaction with the product, don't hesitate to contact the after-sales team to solve the problems or express your feelings or concerns. We **DO VALUE** your voices and are all the time ready to help. All the calls, emails and messages from you will get our immediate reply within 24 hours.

All items can be returned or replaced for any reason within 30 days of the receipt as long as the item is returned in its original product package and all accessories of its original shipment are included.

About Replacement:

If there are missing parts or damages when you receive the item, you don't need to return it if you want to get a replacement. Please contact the after-sales team and we will provide a replacement for free.

About Returns:





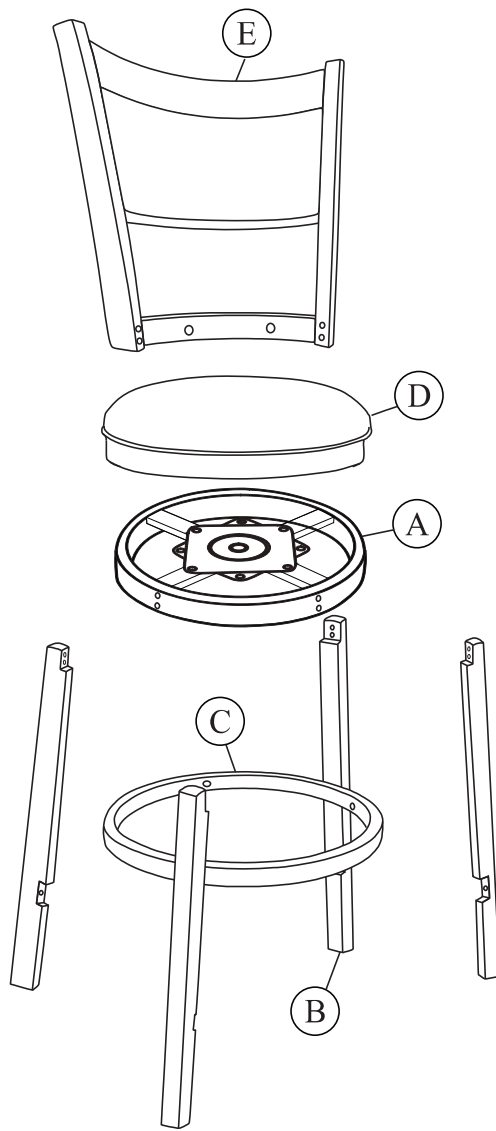

1. Please include a brief description of the problem and photos of the damaged product in your email.
2. **Please Note: If the customer does not contact the after-sales team to get a return label and the customer purchases the return label by themselves, it may incur expensive return shipping charges. And the seller will not bear the fee of the customer's own purchase of the return label**
3. If the product is damaged by the customer, we can refuse to provide a prepaid return label, and the customer needs to pay for the return shipping.
4. Boxes for return shipping will not be provided by the seller. The customers are responsible for using the original shipping boxes, or purchasing new boxes when no boxes.
5. After all returned items arrive at the Return Center, please contact the After-sales team and we will fully refund back to the original payment method.



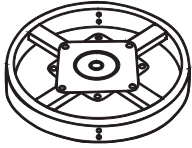

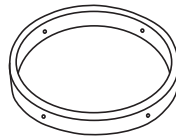
WARRANTY:

Please keep the after-sale card. If the product is damaged by non-human factors within six months, please contact our after-sales team.



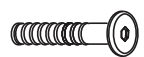
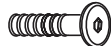



COMPONENTS

<p>Bottom Frame</p>  <p>Ax1</p>	<p>Chair Leg</p>  <p>Bx4</p>	<p>Leg Support</p>  <p>Cx1</p>	<p>Top Frame Cushion</p>  <p>Dx1</p>	<p>Back Rest</p>  <p>Ex1</p>	<p>M6 x 45MM</p>  <p>Fx4</p>
--	---	---	--	---	---

<p>M6 x 40MM</p>  <p>Gx14</p>	<p>M6 x 20MM</p>  <p>Hx4</p>	<p>M6</p>  <p>Ix22</p>	<p>M6</p>  <p>Jx22</p>	<p>M4 Allen Key</p>  <p>Kx1</p>
--	---	---	---	--

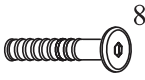
ASSEMBLY INSTRUCTION

Step 1

G	 M6 x 40mm	8
I	 M6	8
J	 M6	8
K	 M4	1

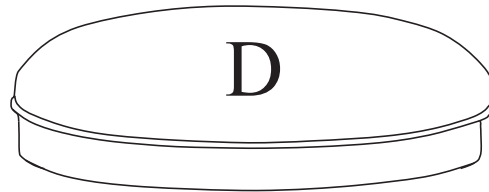



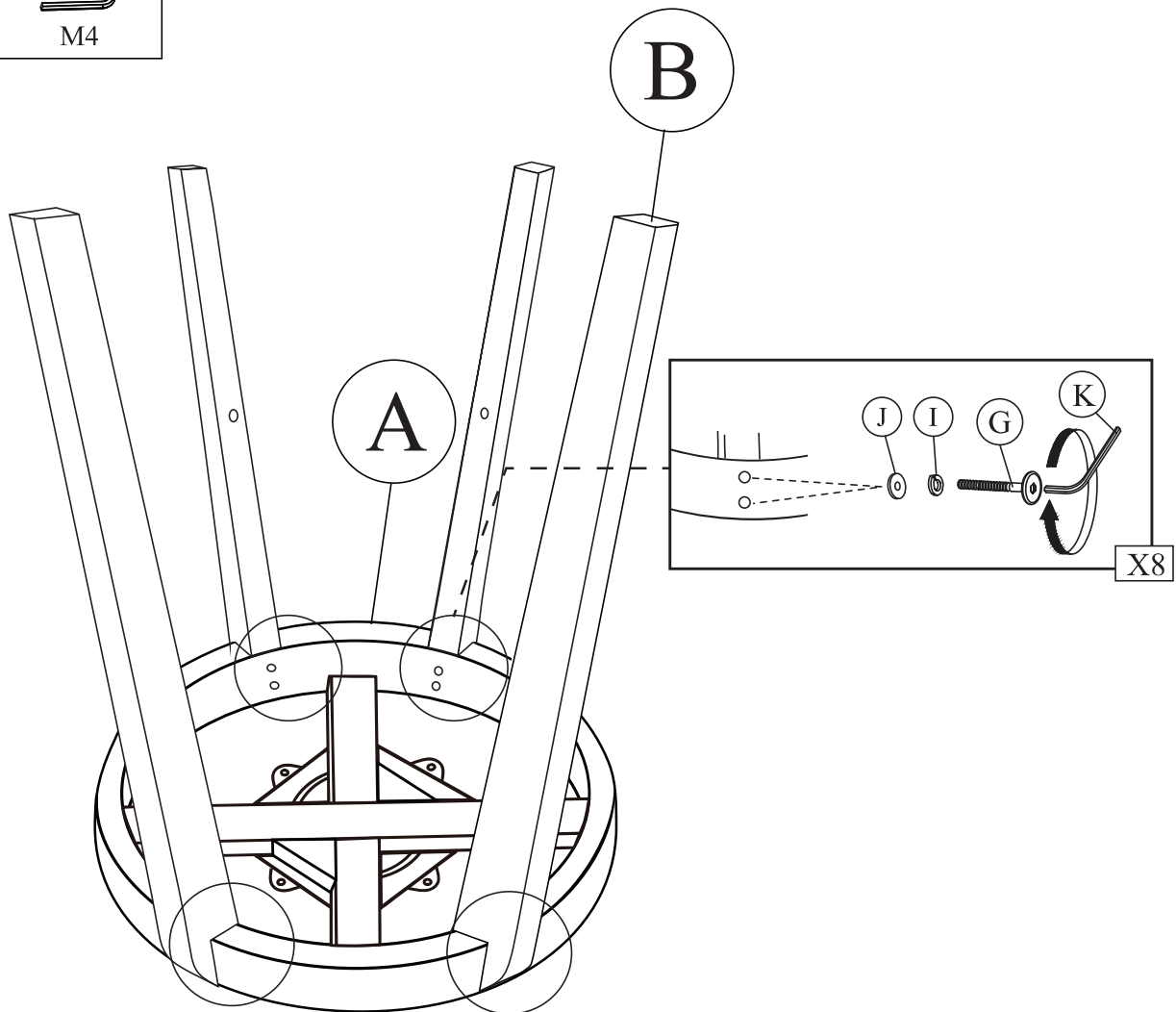

⚠ NOTE: This step is not for the installation of Seat Cushion D.

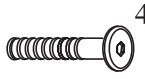

NOTE: Do not fully tighten the 8 screws at this stage. You can turn the screws halfway and then fully tighten them after Step 2.



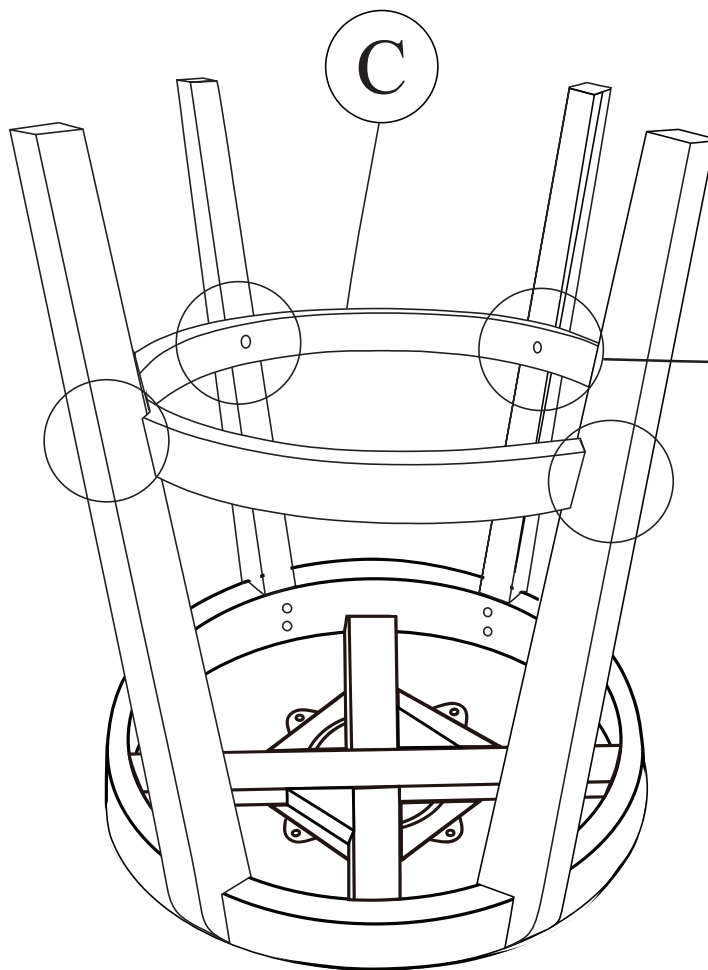
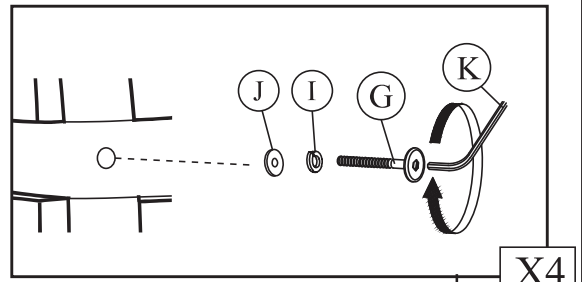

Step 2.

G	 4 M6 x 40mm
I	 4 M6
J	 4 M6
K	 1 M4

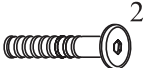

NOTE: Turn the 4 screws halfway first.
Then fully tighten the 8 screws from Step 1 and
the 4 screws from Step 2. This will improve stability.



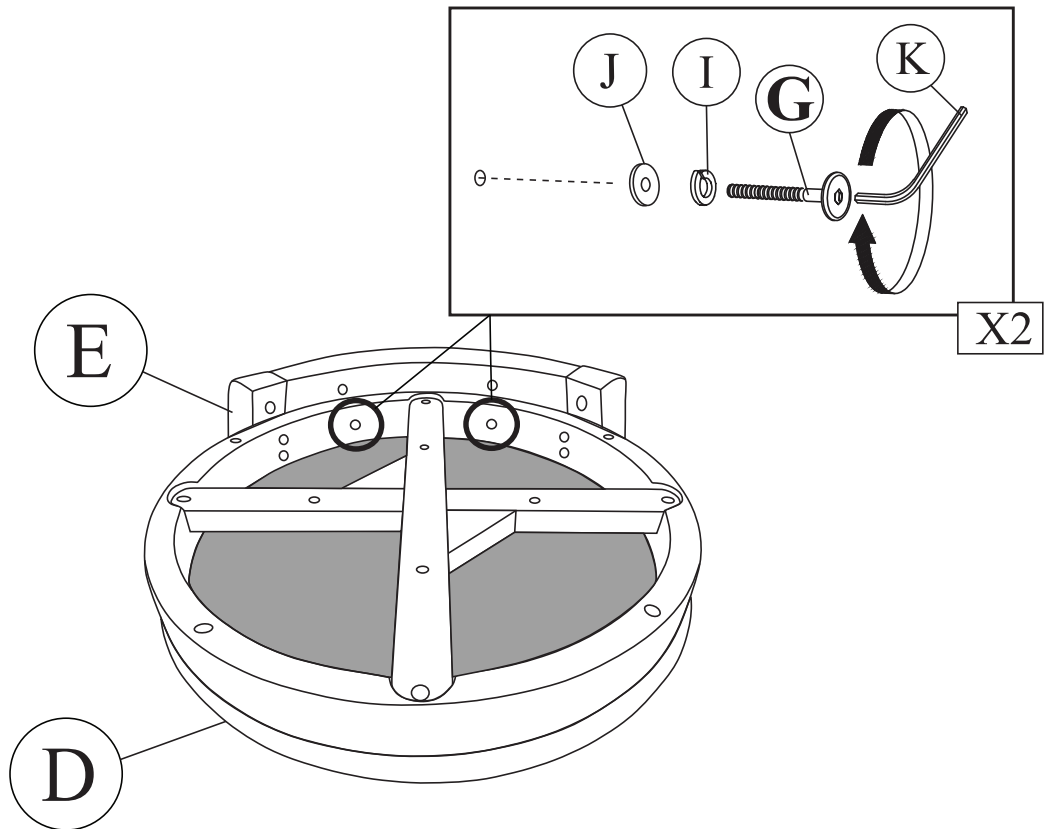

Step 3.

G	 M6 x 40mm	2
I	 M6	2
J	 M6	2
K	 M4	1



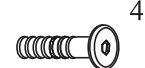

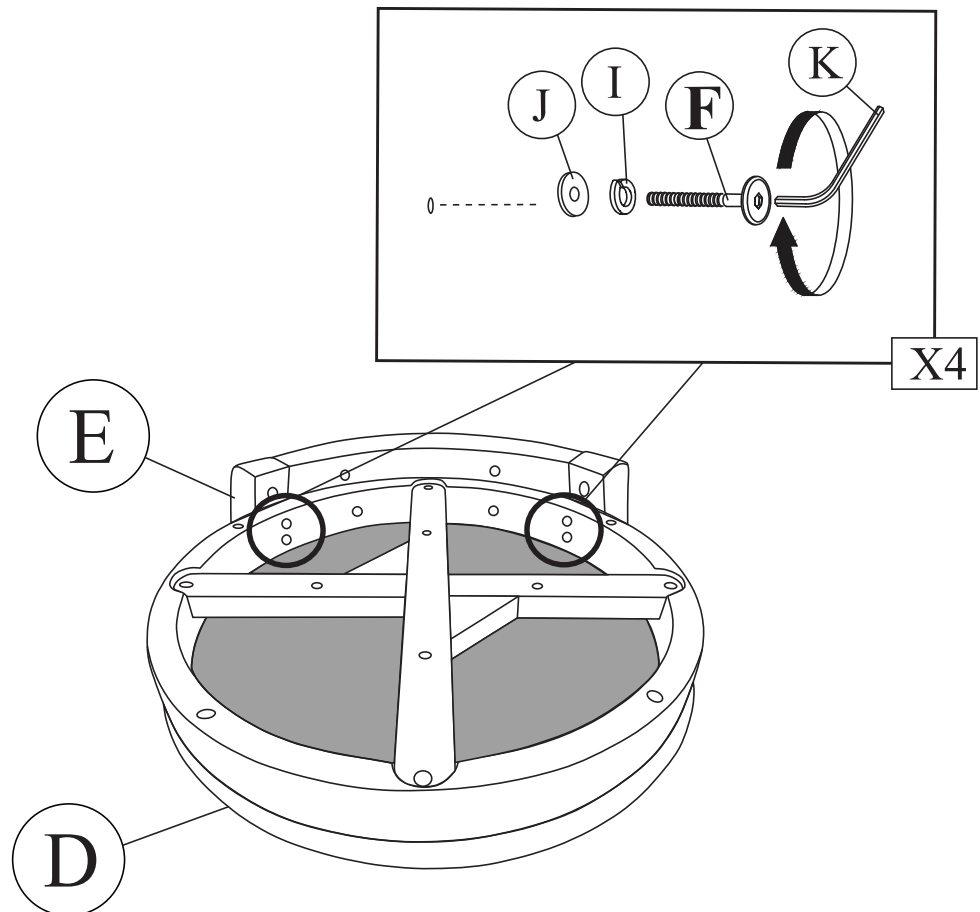

NOTE: Please check the correct model number and length is screw **G - 40mm**, not screw **F - 45mm**, using the wrong screws will result in damage to the chair.

Step 4.

F	 M6 x 45mm	4
I	 M6	4
J	 M6	4
K	 M4	1

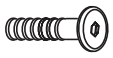

Step 5.

H	 M6 x 20mm	4
I	 M6	4
J	 M6	4
K	 M4	1

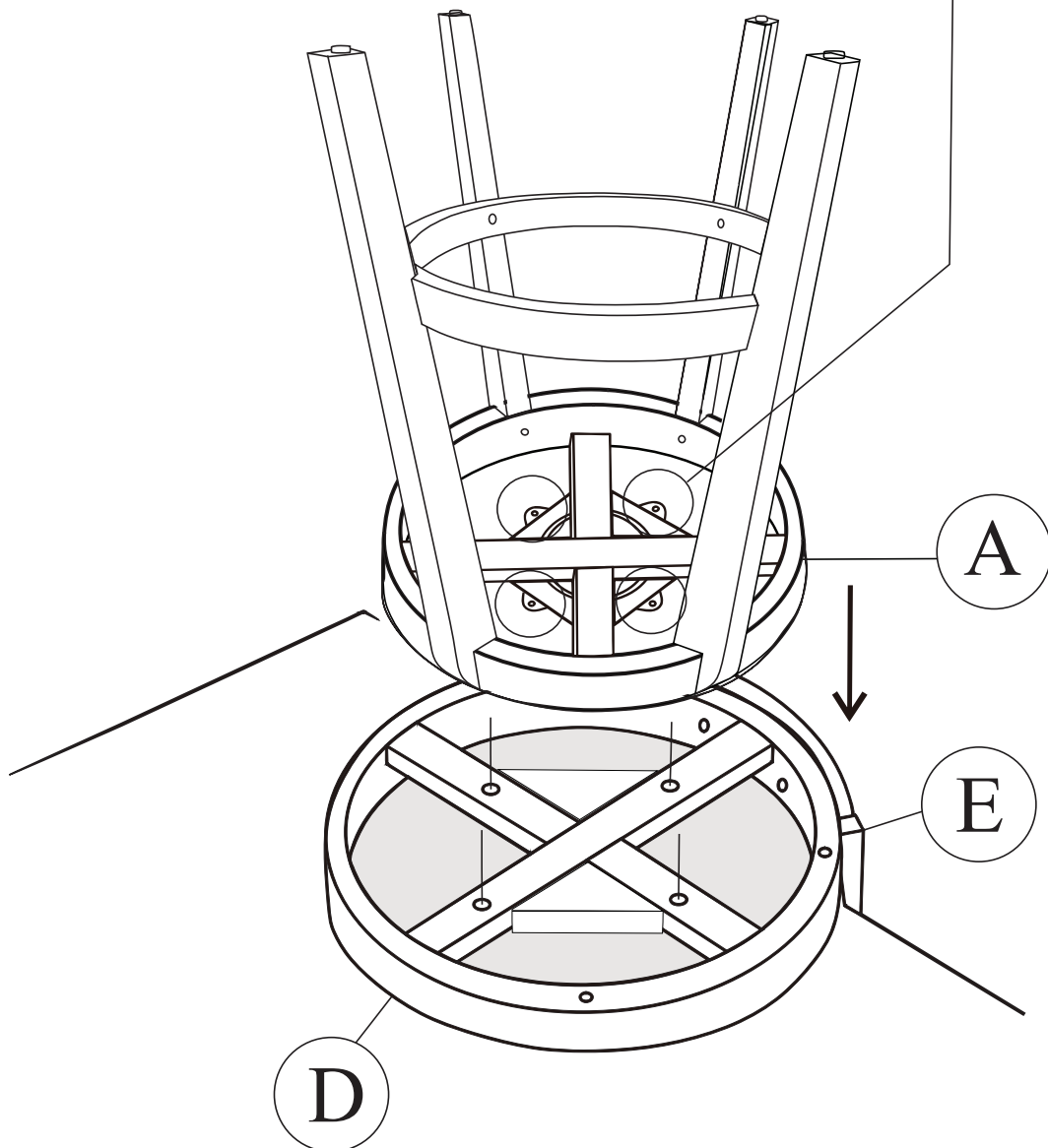
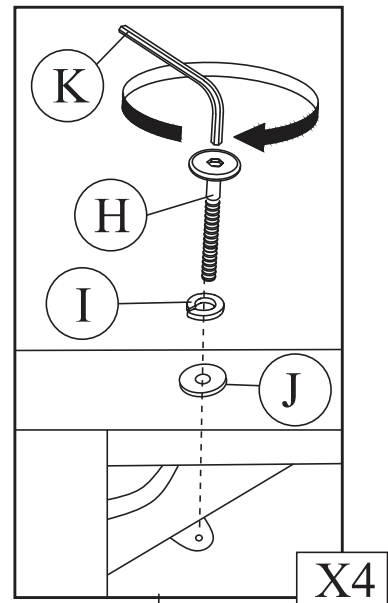

Step 6. **Do not put your hands into the rotating gap to avoid pinching.**

Tighten all the bolts.

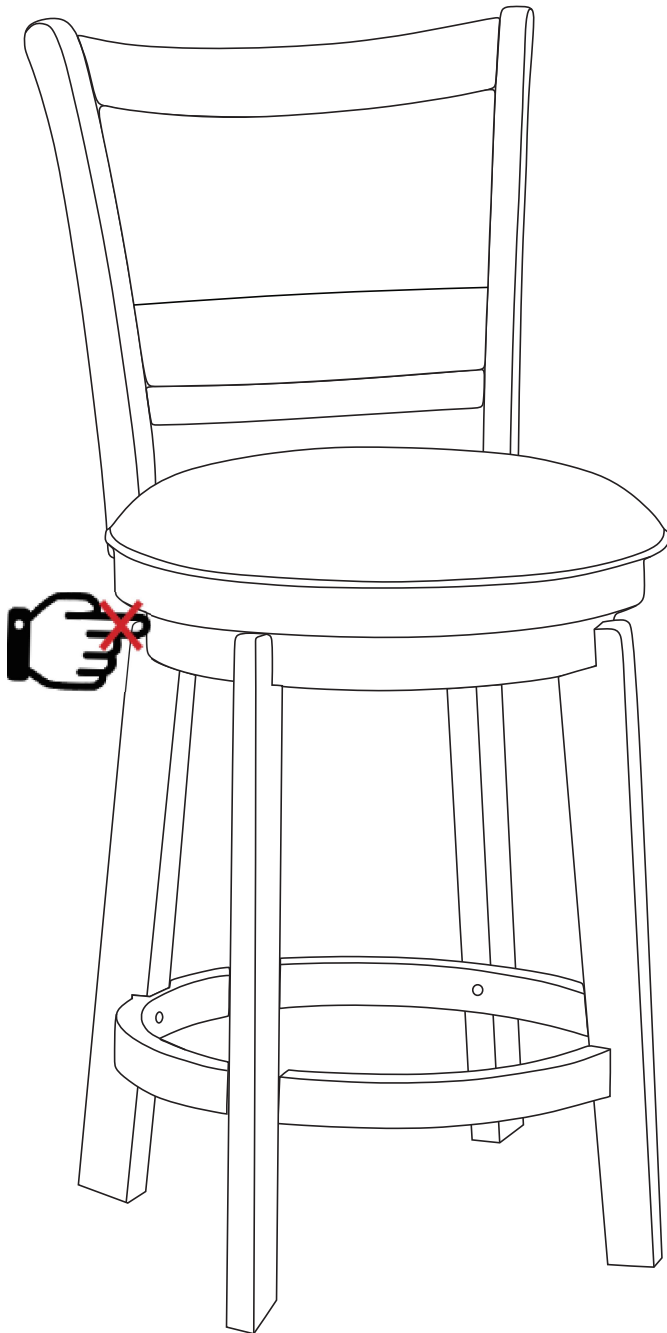

FINISH!!

NOTE: To improve the stability of the barstool, please retighten all the screws after two weeks of assembly and when necessary.

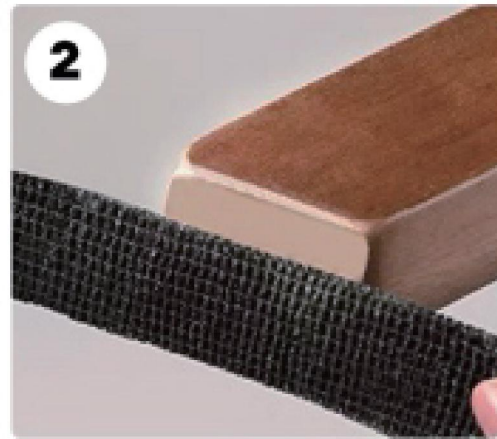

We provide you with universal self-adhesive chair leg floor protector wraps. It is suitable for all chair legs. It allows you not only to adjust the legs to the desired height, but also to make them flush with the floor. It also provides optimal protection for chair legs and quality flooring, eliminating unwanted scratches, reducing noise and extending the life of your furniture.