

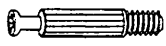









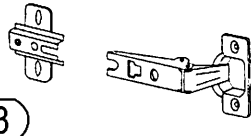





 (A1) 8x30mm x4	 (C1) 5x30mm x8	 (D) x8
 (D1) 16mm x8	 (L3) x2	 (J1) x16
 (E6) 4*14mm x4	 (I2) x1	 (E4) 4*16mm x4
 (E5) 3,5*16mm x16	 (H2) x9	 (Q1) x6
 (E3) 3*20mm x15	 (B) x8	 (R) x1
 (K1) x4	 (B1) 6,3x50mm x8	 (E18) M4*25mm x1

№	B*b	X
1L+1R	408*300	1+1
2L+2R	408*284	1+1
3	600*320	1
4	600*320	1
5	134*280	4
6	400*296	1
7	176*282	1
8	422*150	2



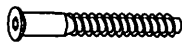

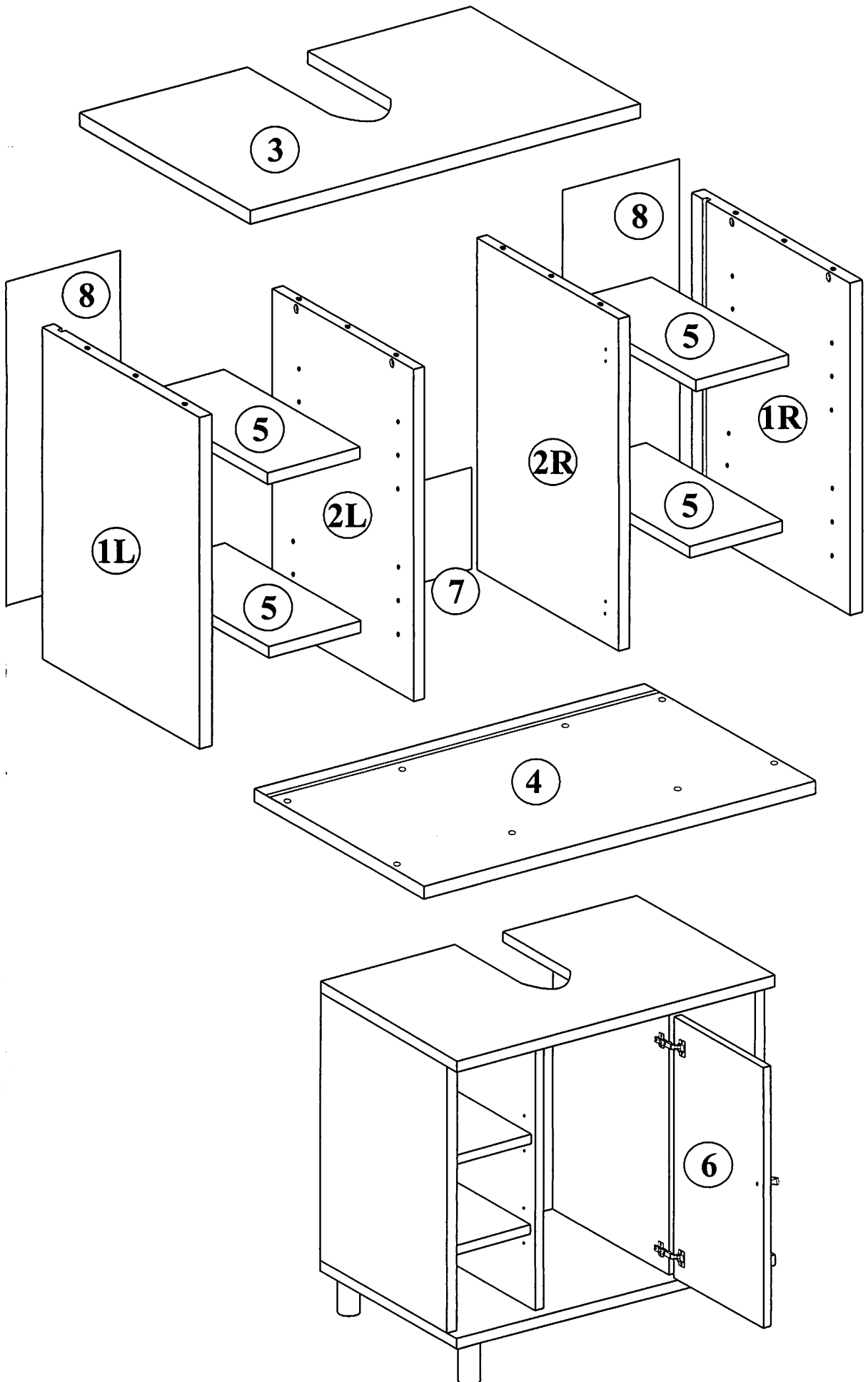
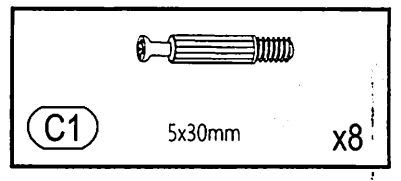
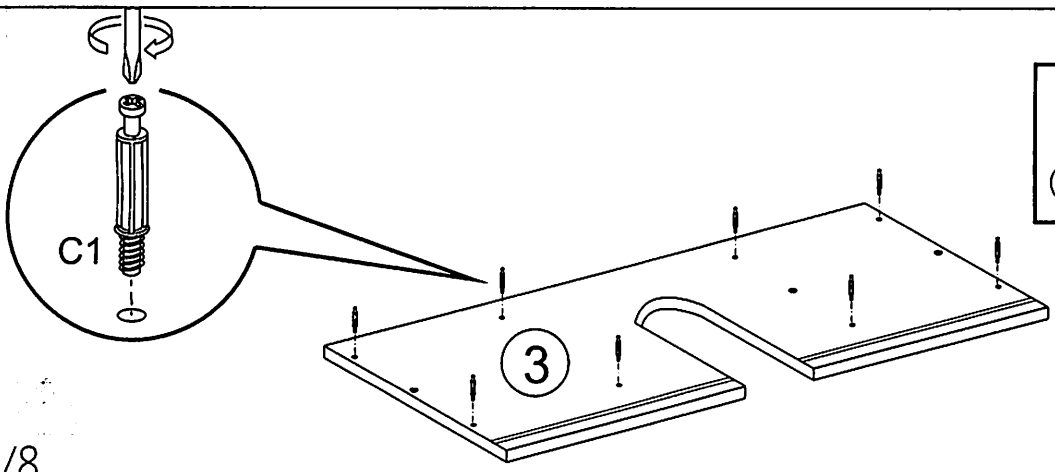
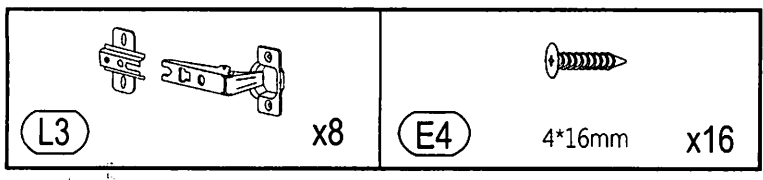
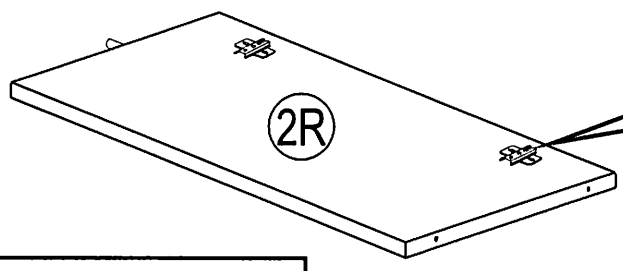
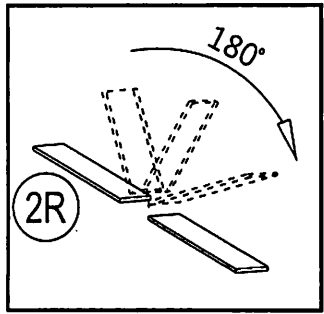
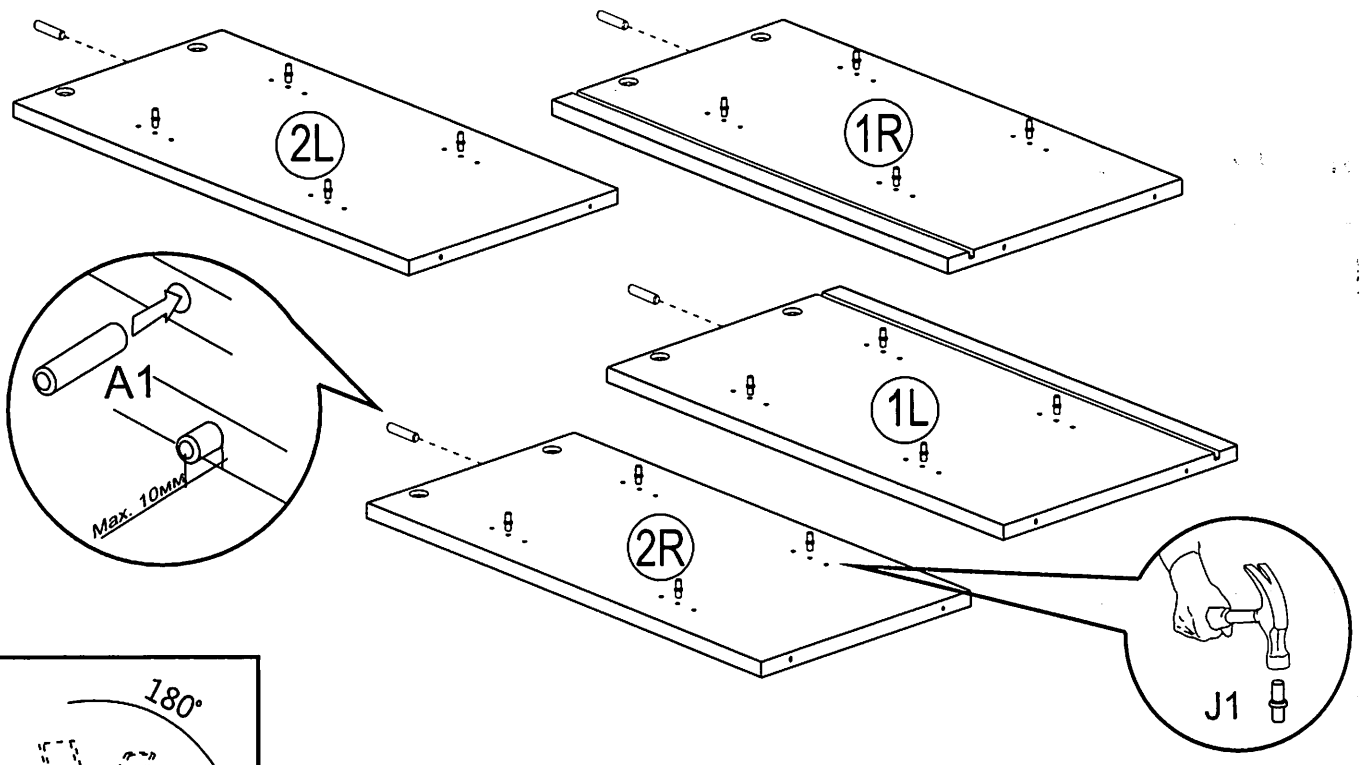
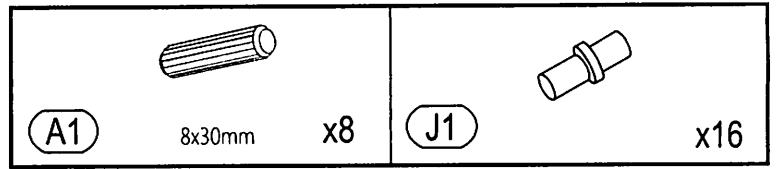
D1		16mm	x8	D		x8
----	---	------	----	---	---	----

