



SOFT, DRY CLOTH



CHEMICAL



HEAT



KEEP DRY



HANDLE WITH CARE

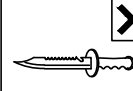

DO NOT USE KNIFE

ASSEMBLY INSTRUCTION

DESCRIPTION : KITCHEN CABINET

HARDWARE	A	B	C	D	E	F	G	H	I	J	K	L	M	N	O	P	Q	R
	WOOD DOWEL 8 X 25 1X9	WOOD DOWEL 8 X 40 1X4	CB SCREW M3X12MM 1X4	CB SCREW M3.5X16MM 1X24	CB SCREW M4X25MM 1X8	CB SCREW M4X38MM 1X10	CSK CAP WOOD M6X50MM 1X18	MINIFIX CAP 1X24	L KEY 1X1	3.5KG MAGNET (1 HOLE) 4 SETS	DOOR SUPPORT SPRING 1X8	MOON HANDLE 1X5	MINIFIX 5654+5546 6 SETS	NAIL 5/8 1X50	FURNITURE GLUE 1X1	SHELF SUPPORT 1X8	MIRROR BRACKET 1X12	DRAWER SLIDE 14" 1 SET

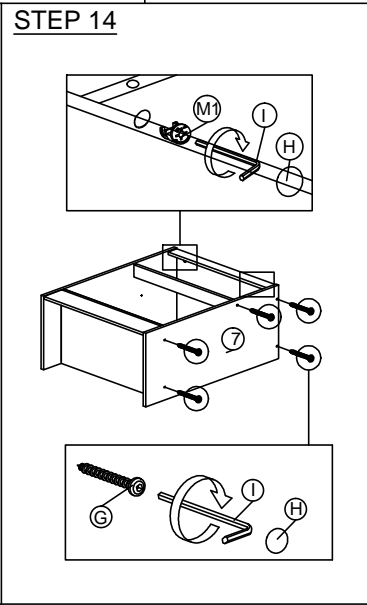
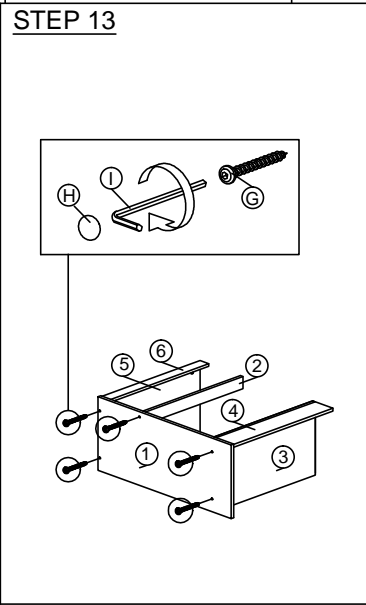
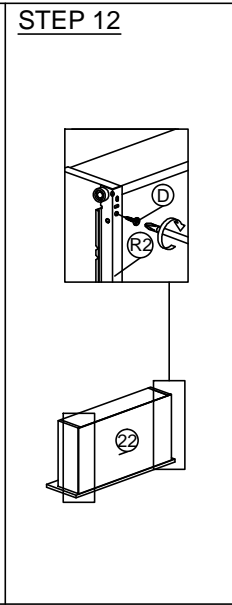
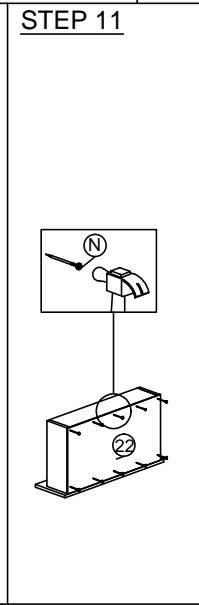
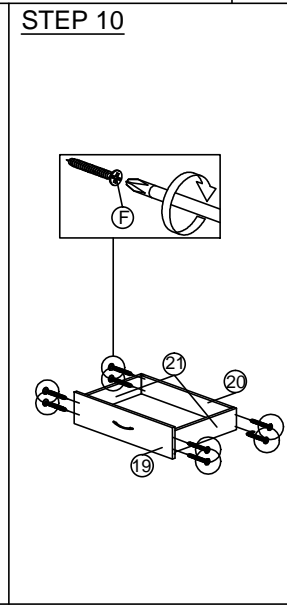
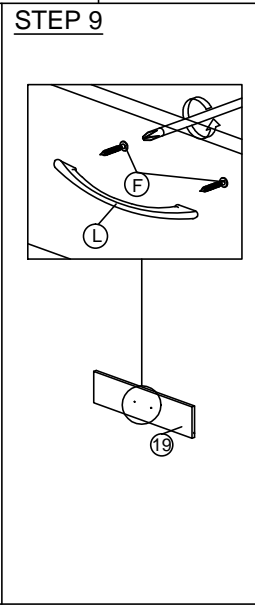
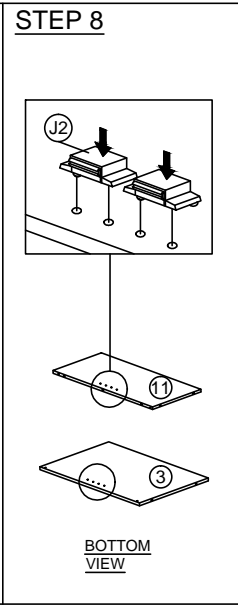
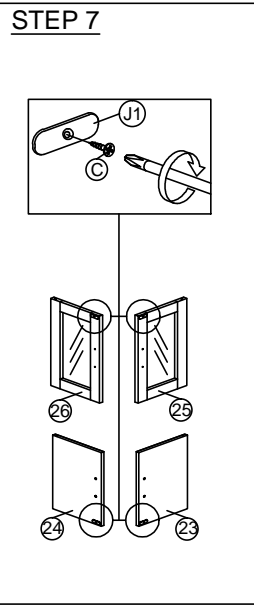
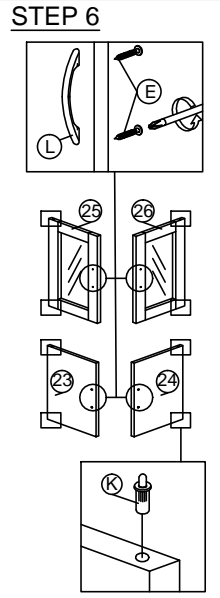
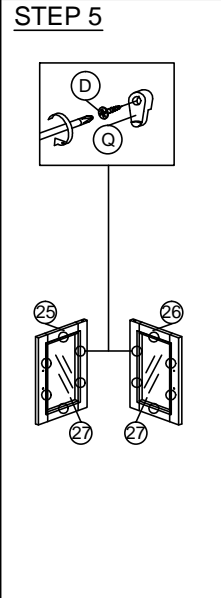
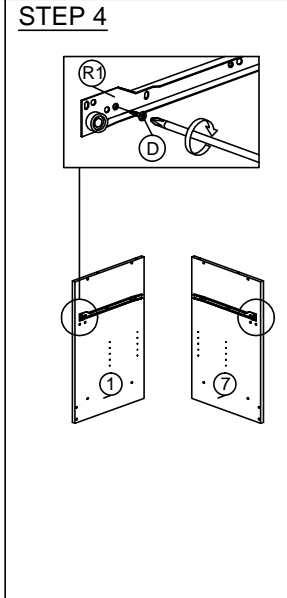
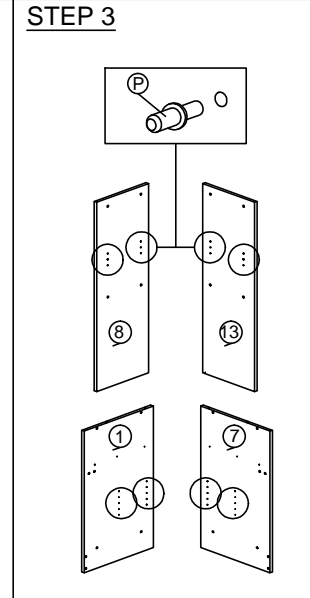
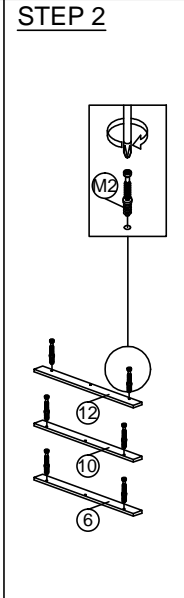
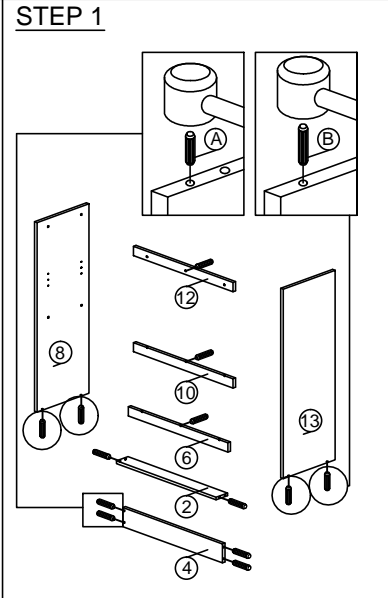
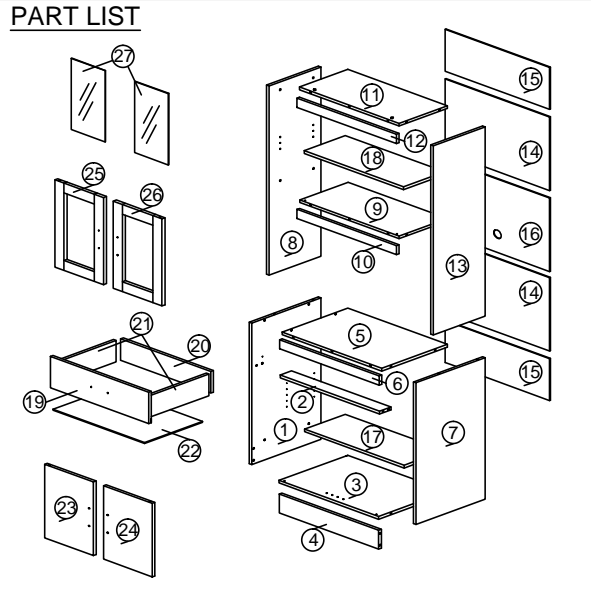

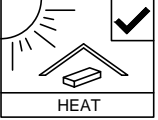

ASSEMBLY INSTRUCTION

DESCRIPTION : KITCHEN CABINET

PART 1

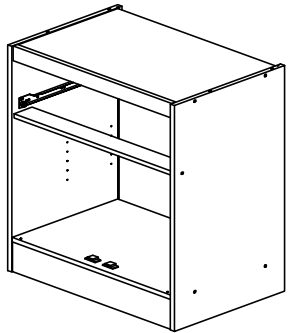

STEP 15

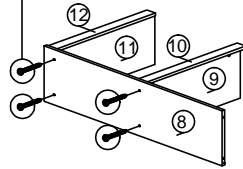
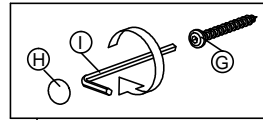

STEP 16

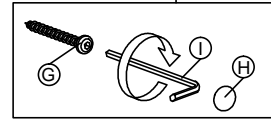
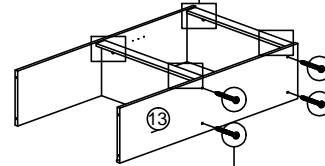
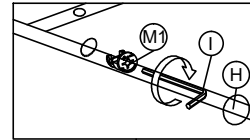

PART 2

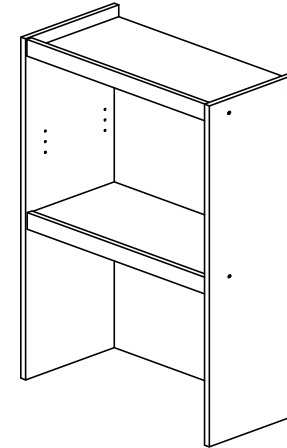

COMPLETED

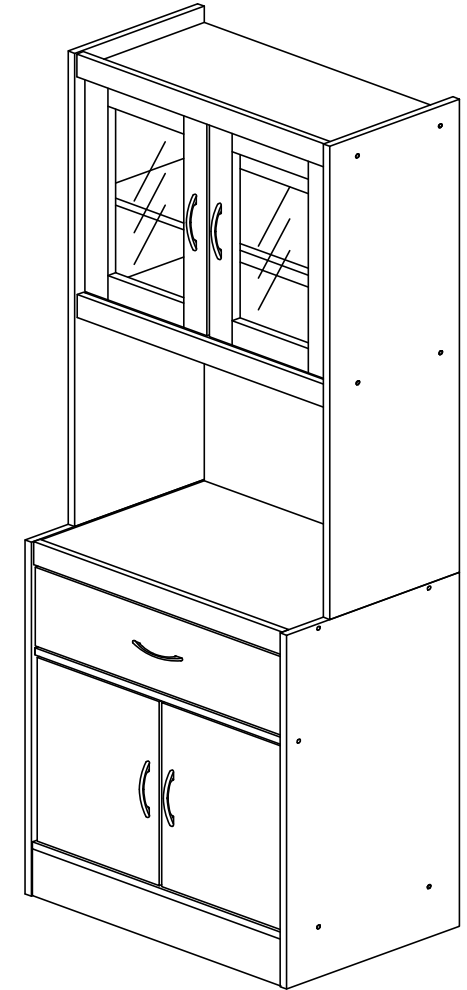

STEP 17

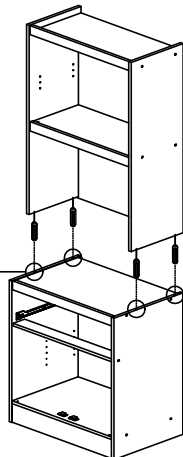
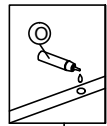

PART 2

PART 1

STEP 18

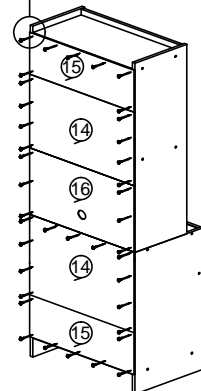
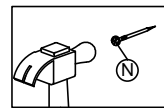

STEP 19

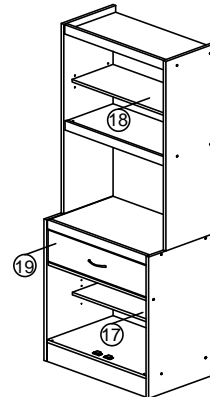

STEP 20

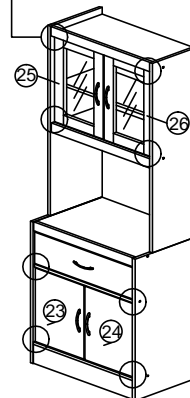
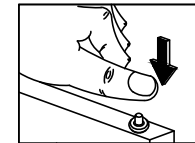



SOFT, DRY CLOTH



CHEMICAL

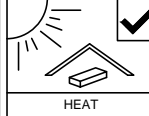

HEAT



KEEP DRY



HANDLE WITH CARE



DO NOT USE KNIFE

ASSEMBLY INSTRUCTION

DESCRIPTION : KITCHEN CABINET

ANTI STOPPER

V



WASHER
X4

W

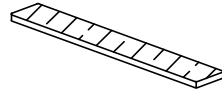

SAFETY STRAP
X2

X

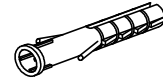

PLASTIC WALL ANCHOR-RED
X2

Y



CB SCREW
M3.5X16MM
X2

Z

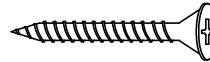

CB SCREW
M4X38MM
X2

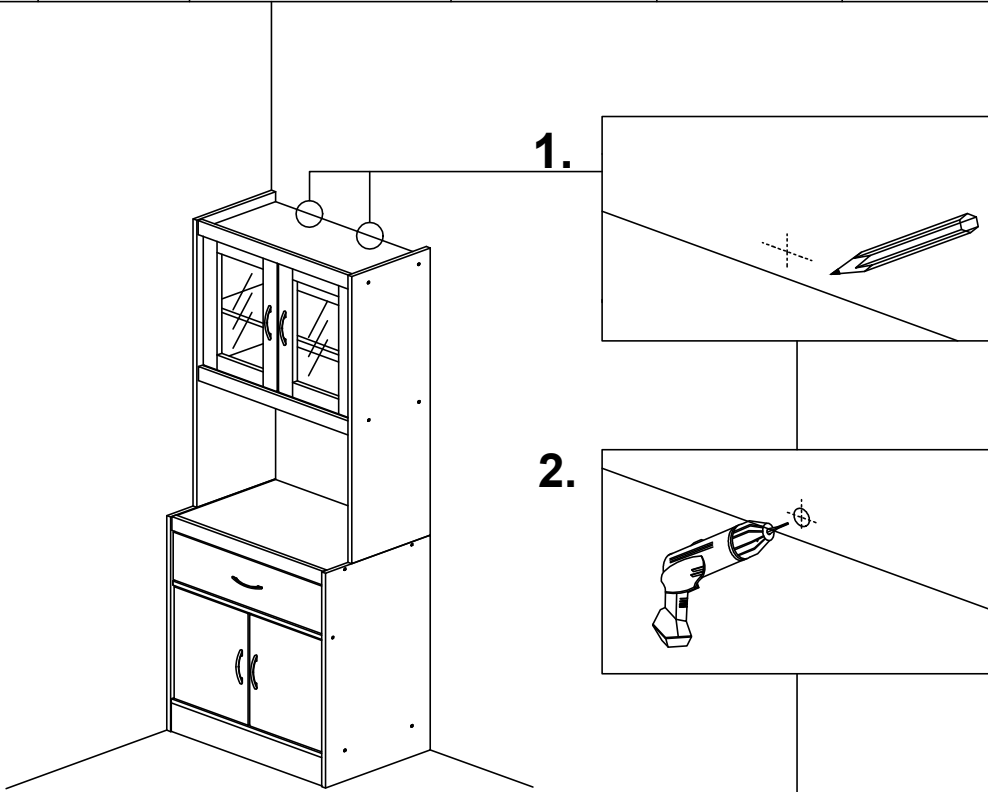

1.

2.

3.

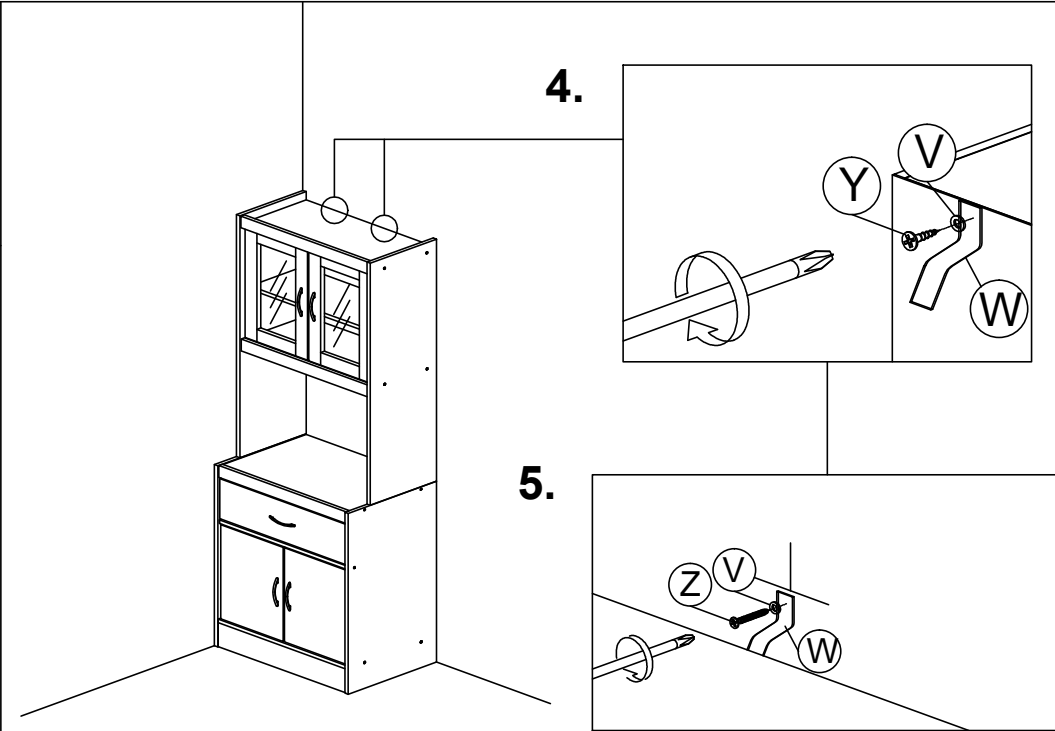
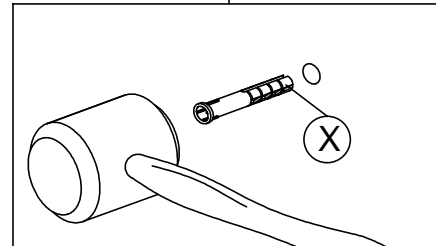
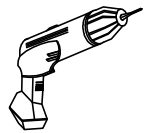

4.

5.

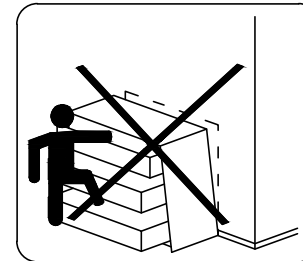
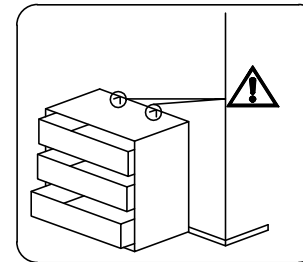

⚠ WARNING

Serious or fatal crushing injuries can occur from furniture tipover. To help prevent tip-over:

- Install tip over restraint provided.
- Place heaviest items in the lower drawers.
- Unless specifically designed to accommodate, do not set TVs or other heavy object on top of this product.
- Never allow children to climb or hang on drawers, doors or shelves.
- Never open more than one drawer at a time. (OR)
- Do not defeat or remove the drawer interlock system.

Use of tipover restraints may only reduce, but not eliminate, the risk of tipover.

This is a permanent label. Do not remove.