

ASSEMBLY INSTRUCTIONS

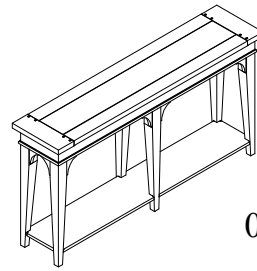

038-925

TOOLS REQUIRED:

Allen Wrench (Provided, Part H)

BEFORE YOU START:

1. Check the parts against the parts list to make sure all items are present.
2. Assemble your furniture on a soft, flat surface to avoid scratching the finish.
3. **CAUTION:** Do not over tighten screws, nuts or bolts during assembly.
4. Your furniture may require occasional tightening.

INSTRUCTIONS:

1. Turn the table upside down on a clean soft surface.
2. Attach "L" Metal Brackets (B) to the legs using the Bolt (C) and the Allen Wrench (H). As shown in Figure 1.
3. Attach four legs to the table using Dowel (A), Bolt (D), Lock Washer (F), Flat Washer (G) and the Allen Wrench (H). As shown in Figure 2.
4. Attach bottom panel to the legs using the Bolt (E), Lock Washer (F), Flat Washer (G) and the Allen Wrench (H). As shown in Figure 3.
5. Repeat step 2, 3 for the last legs.
6. Tighten all bolts before using the table.

Figure 1

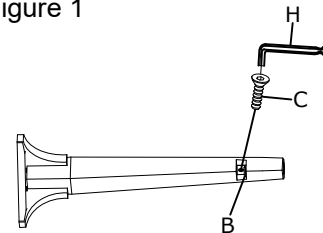

Figure 2

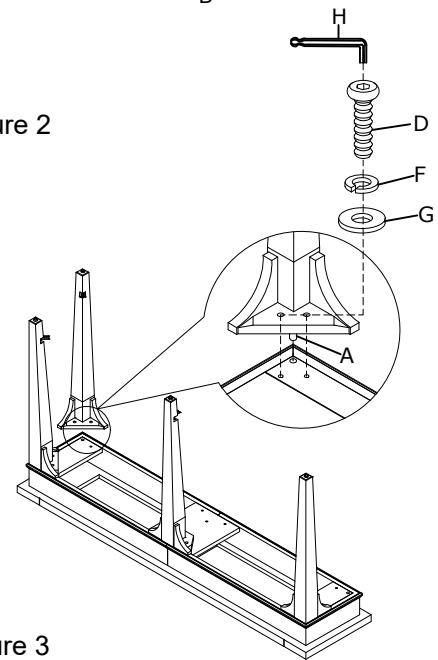
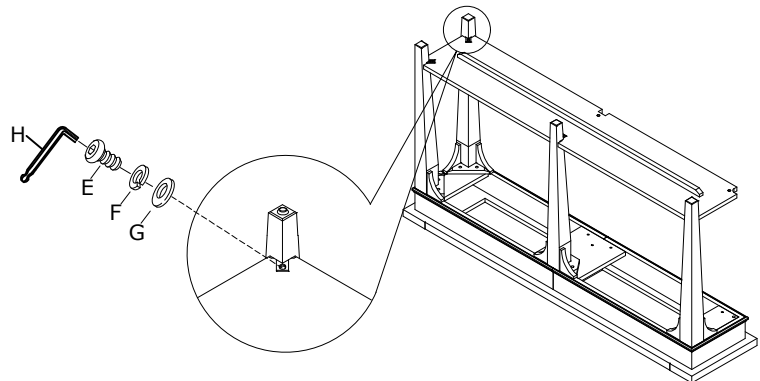







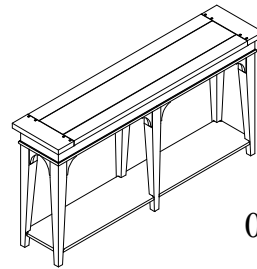

Figure 3



No.	Hardware List	Q'ty
A	 Dowel Ø10*40mmL	6pcs
B	 "L" Metal Brackets	6pcs
C	 Countersink Bolt Ø1/4 "x5/8"	6pcs
D	 Bolt Ø1/4 "x 1-3/8 "	14pcs
E	 Bolt Ø1/4 "x5/8 "	6pcs
F	 Lock Washer Ø1/4"	20pcs
G	 Flat Washer Ø1/4"*16mm	20pcs
H	 Allen Wrench 4MM	1pc





ASSEMBLY INSTRUCTIONS

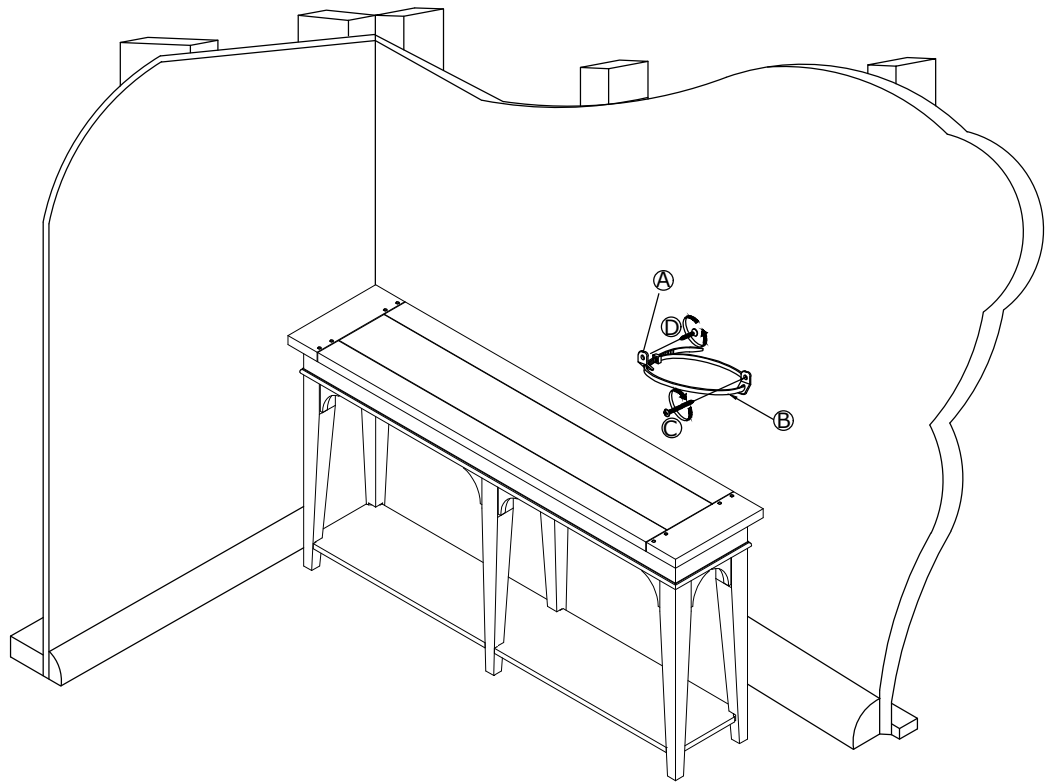

038-925

NOTE : ANTI-TIPPING KIT INSTRUCTIONS:
REFER TO KIT'S BAG



No.	Hardware List	Q'ty
A	 Mounting Bracket	2pcs
B	 Nylon Restraint	1pc
C	 Long screw	1pc
D	 Short screw	1pc