

# Assembly Instructions

## Hanging Chair

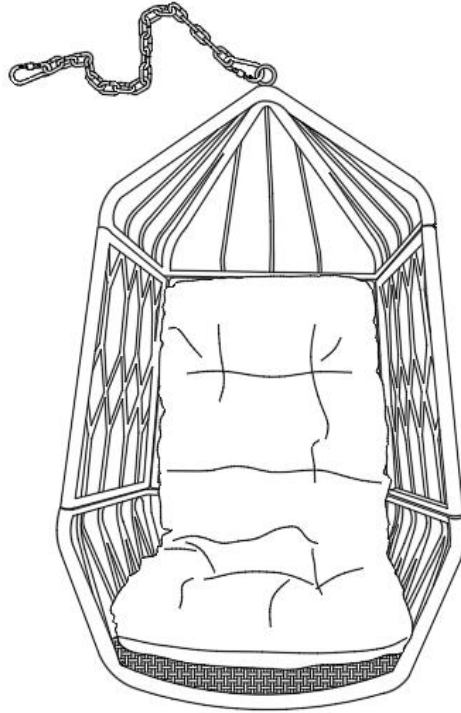







**⚠ WARNING:**



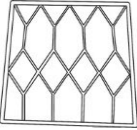

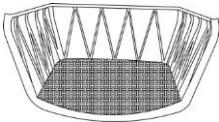
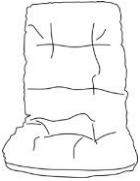

**Thank you for purchasing the Hanging Chair. Please read below before you proceed.**



- 1. Not intended for use by children 12 years of age or younger.**
- 2. This is a hanging chair, not a swing chair.**
- 3. The hanging chair should be installed no more than 20" above ground.**
- 4. The hanging chair should be installed at a minimum of 4-5 feet away from the walls.**
- 5. The hanging chair should have a minimum clearance of 30" from any obstacles.**
- 6. Do not swing on or in the chair. It could cause the product to tip over, resulting in possible injury.**
- 7. This chair basket is not a toy.**
- 8. No mounting hardware kit included.**
- 9. Professional installation required.**

## Parts List





| No.      | Picture   | Description | Qty |
|----------|---|-------------|-----|
| <b>A</b> |    | Top         | 1   |
| <b>B</b> |    | Left Back   | 1   |
| <b>C</b> |    | Middle Back | 1   |
| <b>D</b> |   | Right Back  | 1   |
| <b>E</b> |  | Seat        | 1   |
| <b>F</b> |  | Cushion     | 1   |
| <b>G</b> |  | Iron Chain  | 1   |

## Hardware

|   |   |                |    |
|---|---|----------------|----|
| ① |  | Bolt (M6x40MM) | 13 |
| ② |  | Bolt (M6x30MM) | 3  |
| ③ |  | Washer         | 27 |
| ④ |  | Nut            | 13 |
| ⑤ |  | Nut Cap        | 15 |
| ⑥ |  | Nut Cap        | 13 |

|   |   |           |   |
|---|---|-----------|---|
| ⑦ |   | Allen key | 1 |
| ⑧ |  | Wrench    | 1 |

## Assembly Steps

-  • *Read the instructions before you start the assembly.*
-  • *May need assistance for assembly.*
-  • *Assemble on a clean and smooth surface.*
-  • *Save all package until finished.*

### Overview

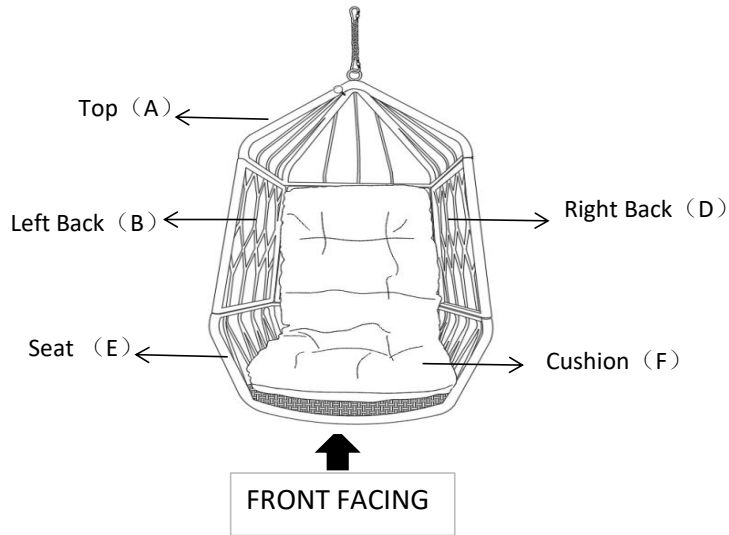

**This Basket has multiple parts and may require up to 30 minutes to assemble. The above picture is to help you put the various parts into perspective. Please read through the instructions below to familiarize yourself with the parts and steps before assembly.**

### Step 1

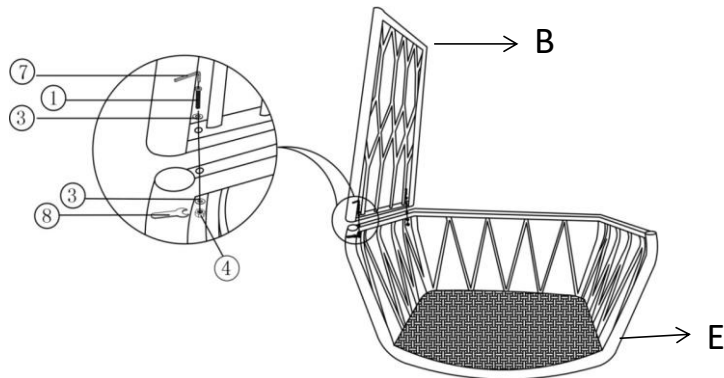

**Unpack and place all parts on a clean surface. Assemble Left Back (B) and Seat (E) by using Bolt (①), Nut (④) Washer (③) with Allen Key (⑦) and Wrench (⑧). Do not tighten.**

## **Step 2**

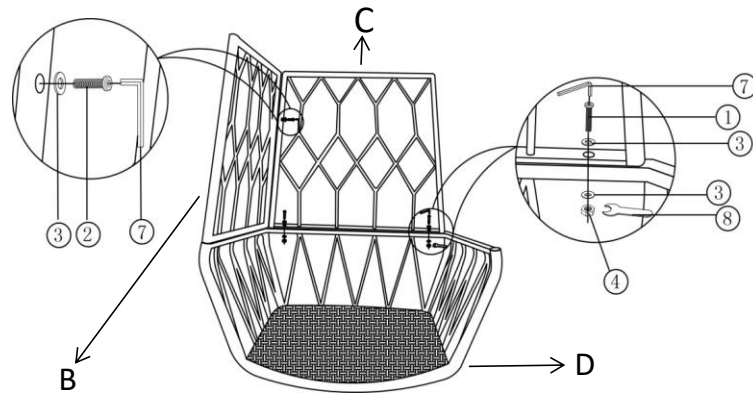

Assemble Middle Back (C) and Seat (E) by using Bolt ( ① ), Nut ( ④ ) Washer ( ③ ) with Allen Key ( ⑦ ) and Wrench ( ⑧ ). Then assemble Middle (C) and Left Back (B) by using Bolt ( ② ) and Washer ( ③ ) with Allen Key ( ⑦ ). Do not tighten.

## **Step 3**

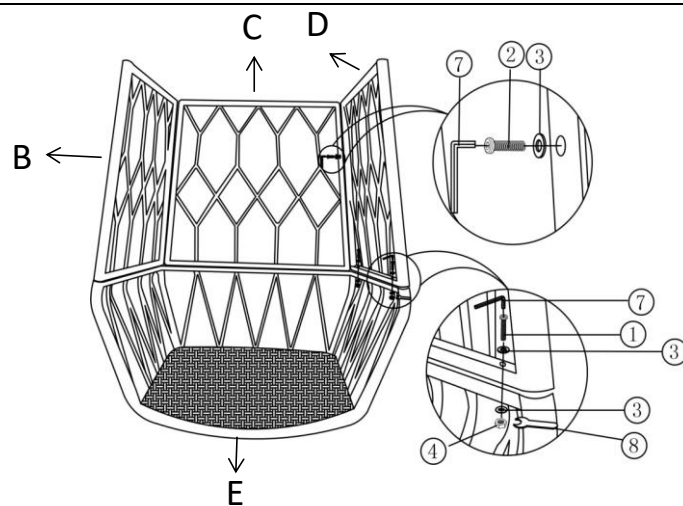

Assemble Right Back (D) and Seat (E) by using Bolt ( ① ), Nut ( ④ ) and Washer ( ③ ) with Allen Key ( ⑦ ) and Wrench ( ⑧ ). Then assemble Right Back (D) and Middle (C) by using Bolt ( ② ) and Washer ( ③ ) with Allen Key ( ⑦ ). Do not tighten.

## **Step 4**

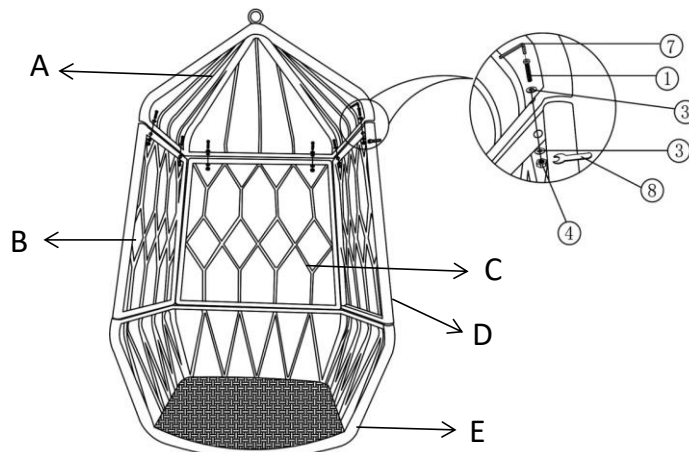

Assemble Top (A) and three back panels (B, C, D) by using Bolt ( ① ), Nut ( ④ ) Washer ( ③ ) with Allen Key ( ⑦ ) and Wrench ( ⑧ ). Do not tighten.

### **Step 5**

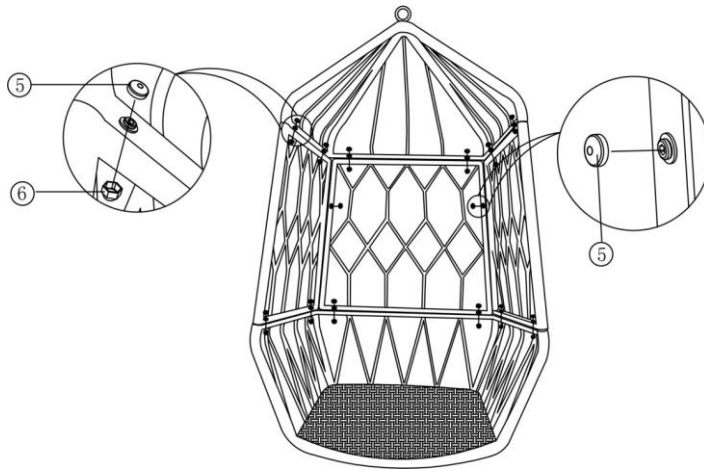

Tighten all screws and nuts . Then add the Nut Caps ( ⑤, ⑥ ) on all the Bolts .

### **Step 6**

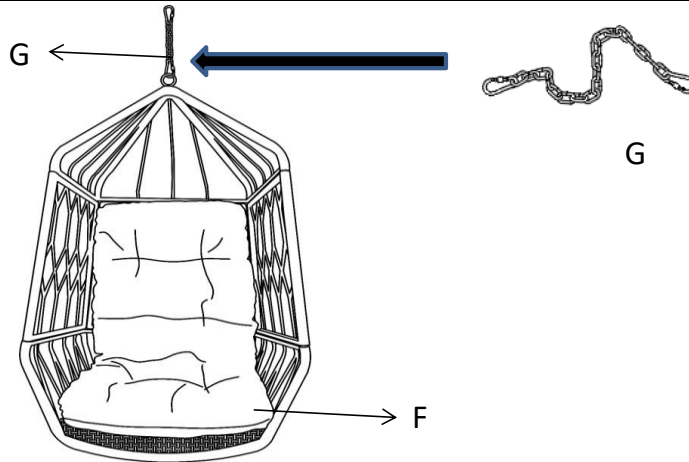





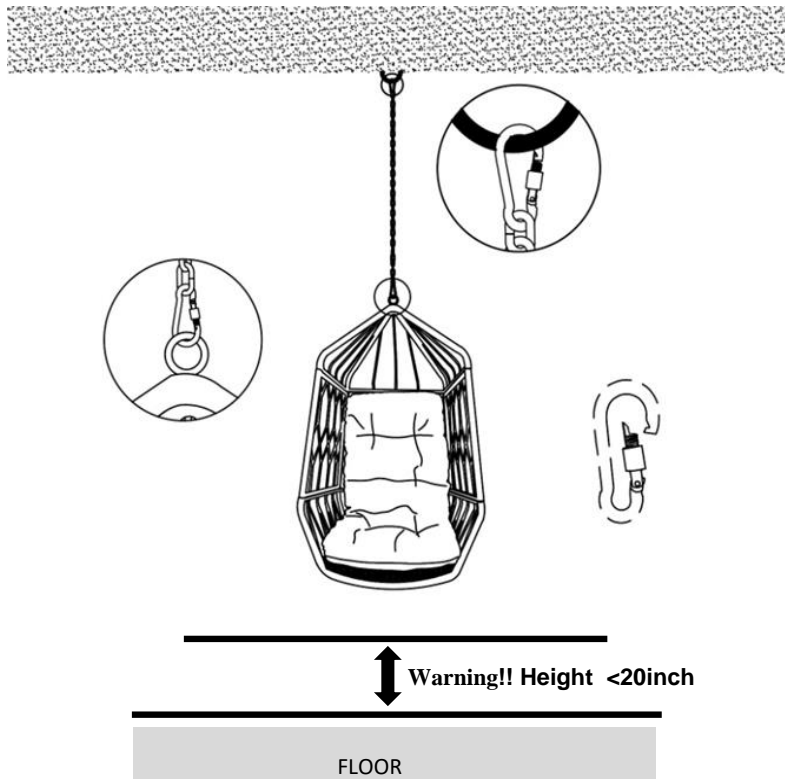





Add the Iron Chain ( G ) to the top of the basket . Then place the Cushion ( F ) on the Basket.

### **Step 7**



Hang the basket on the ceiling, your hanging chair is ready for use.

## **Care & Maintenance**

- ⊘  ● Prolonged exposure to rain may cause rusting which can stain floors.
- ⊘  ● Do not put hot items directly on furniture surface.
- ⊘  ● Do not clean furniture with harsh cleansers or polish.
- ✓  ● To obtain the longest lifespan of your outdoor products, minimizing exposure to direct sunlight is recommended.
- ⊘  ● Children should not climb or jump on the furniture.
- ✓  ● To obtain the longest lifespan of your outdoor products, avoid extended and lengthy exposure to rain, snow, and direct sunshine. Whenever possible cover the product and /or place under patio or awnings.
- ⊘  ● Not for commercial use. For residential use only.
- ⊘  ● Stains may be removed with mild soap solution and damp cloth.
- ✓  ● Keep away from sources of ignition
- ✓  ● Dust and Pick-up spills: Use a Clean, non-colored, lint free cloth.