

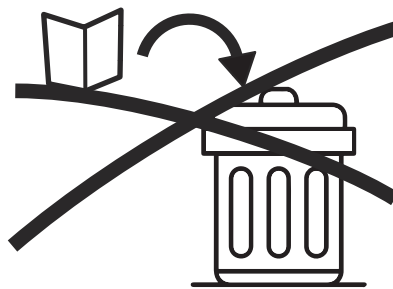

ASSEMBLY INSTRUCTIONS

NOTICE

IMPORTANT, RETAIN FOR FUTURE REFERENCE: READ CAREFULLY
WICHTIG, FÜR SPÄTERE NACHSCHLAGE AUFBEWAHREN: SORGFÄLTIG LESEN
IMPORTANTE, GUARDAR PARA REFERENCIA FUTURA: LEER ATENTAMENTE
IMPORTANTE, CONSERVARE PER RIFERIMENTI FUTURI: LEGGERE ATTENTAMENTE
IMPORTANT, À CONSERVER POUR RÉFÉRENCE FUTURE : LIRE ATTENTIVEMENT

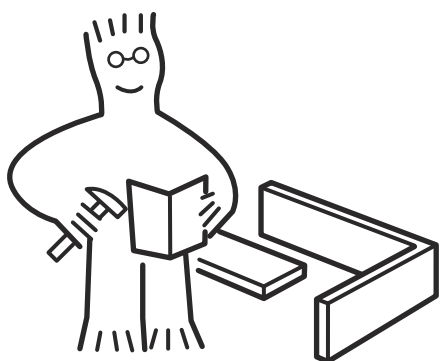

Assemble on a flat, clean and soft surface.
Auf einer ebenen, sauberen und weichen Oberfläche zusammenbauen.
Assembler sur une surface plate, propre et douce.
Assemblare su una superficie piatta, pulita e morbida.
Ensamblar sobre una superficie plana, limpia y suave.

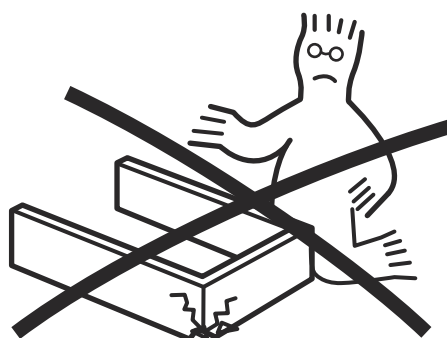
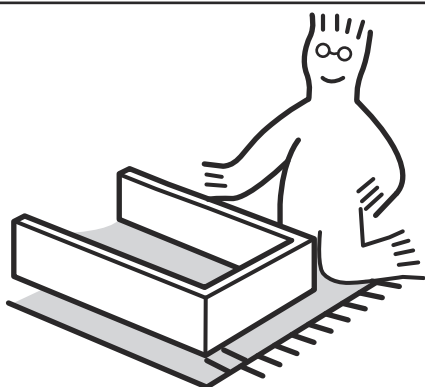

Professional installation is highly recommended.
Eine professionelle Installation wird dringend empfohlen.
Une installation professionnelle est fortement recommandée.
Si raccomanda vivamente l'installazione professionale.
Se recomienda altamente la instalación profesional.



Periodically Check That All Components Are Tightly Secured.
Überprüfen Sie Regelmäßig, Dass Alle Komponenten Fest Gesichert Sind.
Vérifiez Périodiquement Que Tous Les Composants Sont Bien Fixés.
Controllare Periodicamente Che Tutti I Componenti Siano Ben Fissati.
Verifique Periódicamente Que Todos Los Componentes Estén Bien Asegurados.



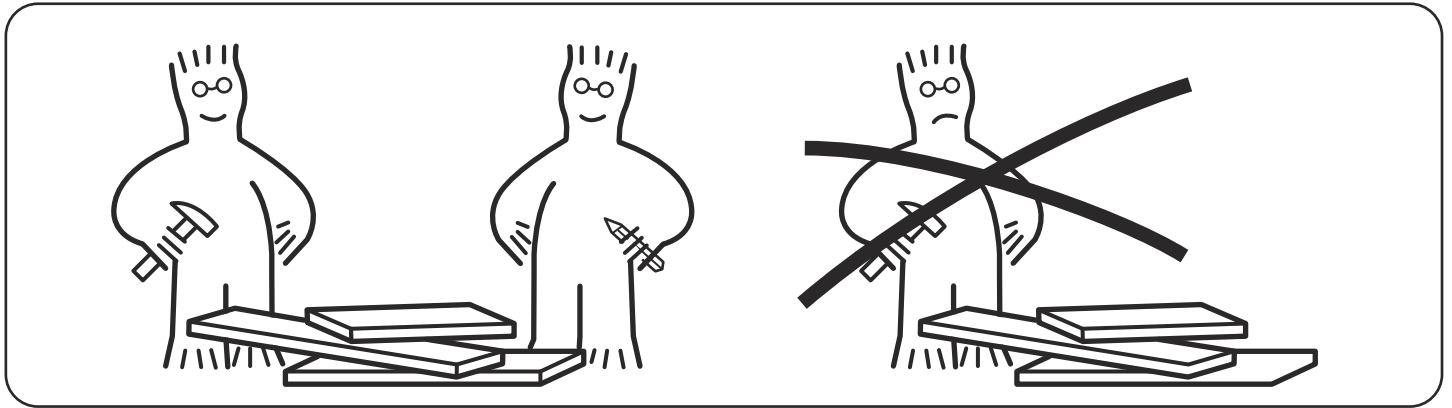

It is recommended that multiple people assemble this product.
Es wird empfohlen, dass mehrere Personen dieses Produkt zusammenbauen.
Il est recommandé que plusieurs personnes assemblent ce produit.
Si raccomanda che più persone assemblino questo prodotto.
Se recomienda que varias personas ensamblen este producto.



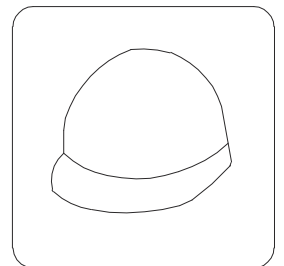
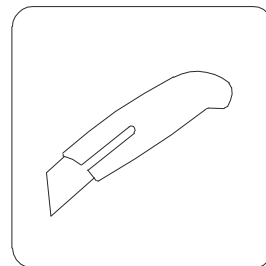
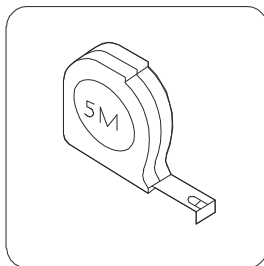
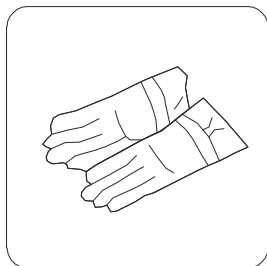
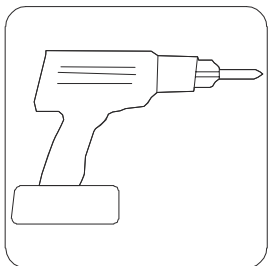

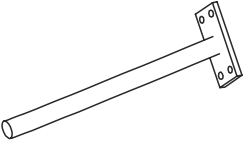
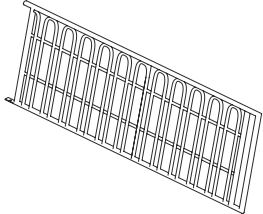
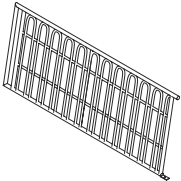
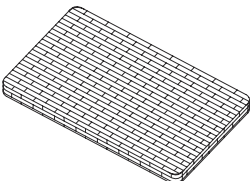
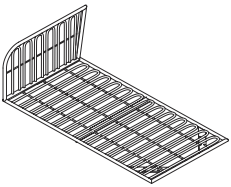

Please have the following auxiliary tools ready:

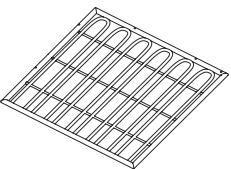
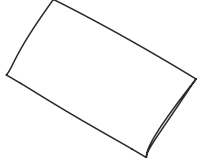
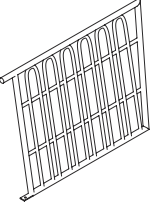
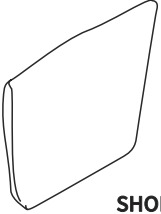
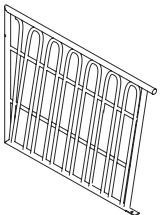
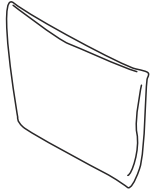
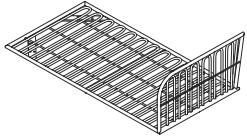
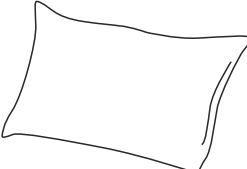

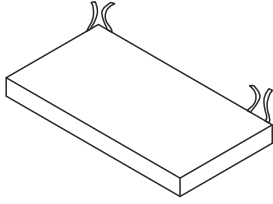
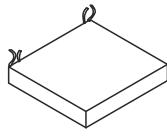
PARTS

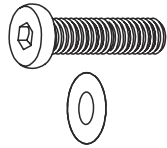
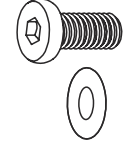
| Item no. Nr. N°d'article Articolo No. Artículo No. | Reference Image Referenzbild Image de référence Immagine di riferimento Imagen de referencia | Qty. Menge Qté. Qtà Cant. | Item no. Nr. N°d'article Articolo No. Artículo No. | Reference Image Referenzbild Image de référence Immagine di riferimento Imagen de referencia | Qty. Menge Qté. Qtà Cant. |
|--|--|---------------------------------------|--|--|---------------------------------------|
| 1 |  | X12 | 8 |  | X1 |
| 2 |  | X1 | 9 |  | X1 |
| 3 |  | X1 | 10 |  | X4 |
| 4 |  | X1 | 11 |  | X2 |
| 5 |  | X1 | 12 |  SHORT | X1 |
| 6 |  | X1 | 13 |  LONG | X1 |
| 7 |  | X1 | 14 |  | X4 |

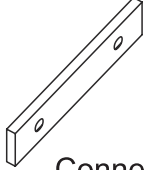
| Item no. Nr. N°d'article Articolo No. Artículo No. | Reference Image Referenzbild Image de référence Immagine di riferimento Imagen de referencia | Qty. Menge Qté. Qtà Cant. |
|--|--|---------------------------------------|
| 15 |  | X2 |
| 16 |  | X1 |

| Item no. Nr. N°d'article Articolo No. Artículo No. | Reference Image Referenzbild Image de référence Immagine di riferimento Imagen de referencia | Qty. Menge Qté. Qtà Cant. |
|--|--|---------------------------------------|
| A |  M6 x 40mm | X13 |
| B |  M6 x 20mm | X72 |
| C |  | X4 |
| D |  Connector | X2 |
| E |  Allenkey | X2 |

EXPLODED VIEW

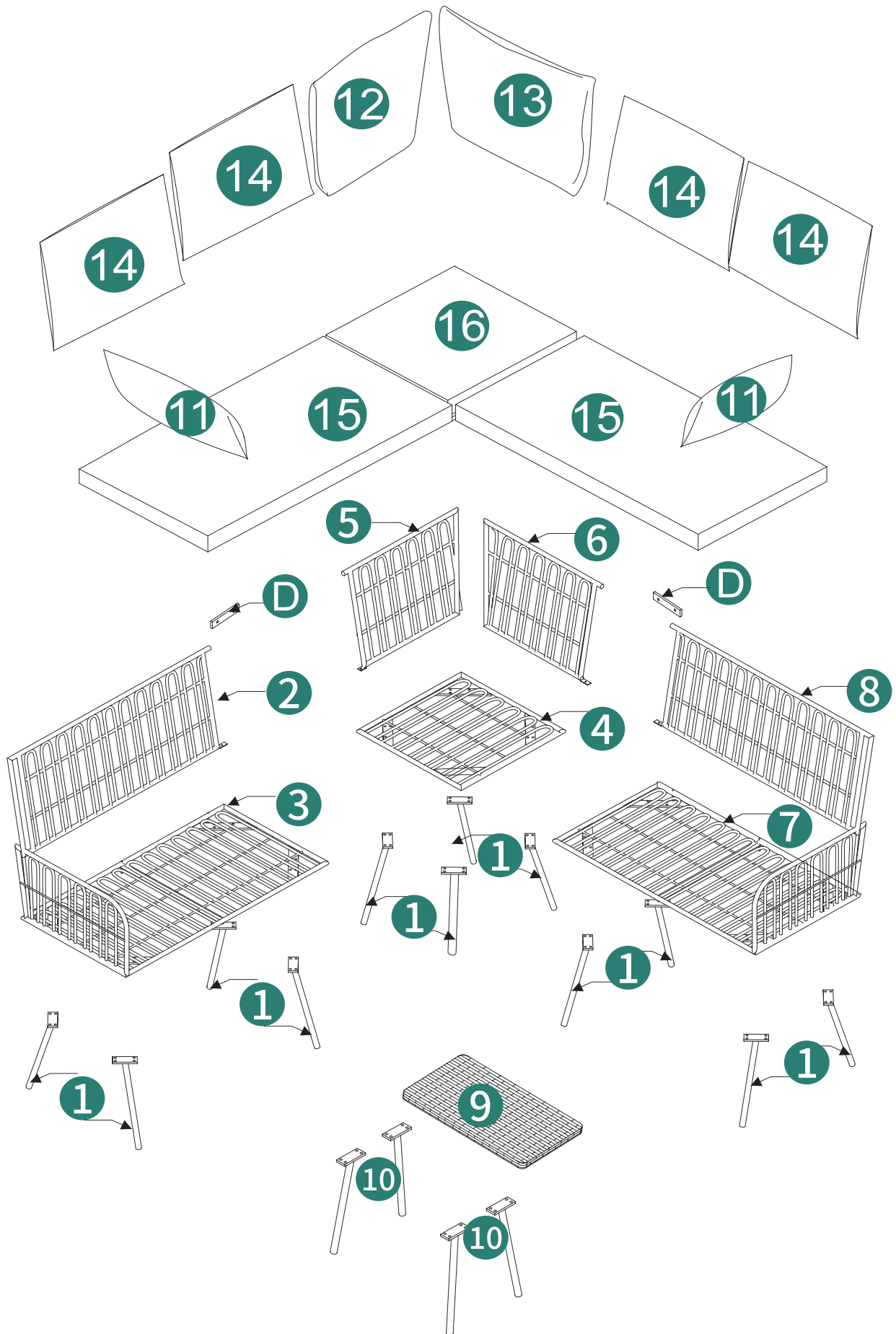

ASSEMBLY

1



② 1pc



③ 1pc

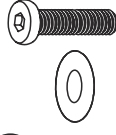

Ⓐ 4pcs

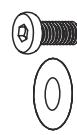

Ⓑ 1pc

Do not tighten all the screws until completing step 2.

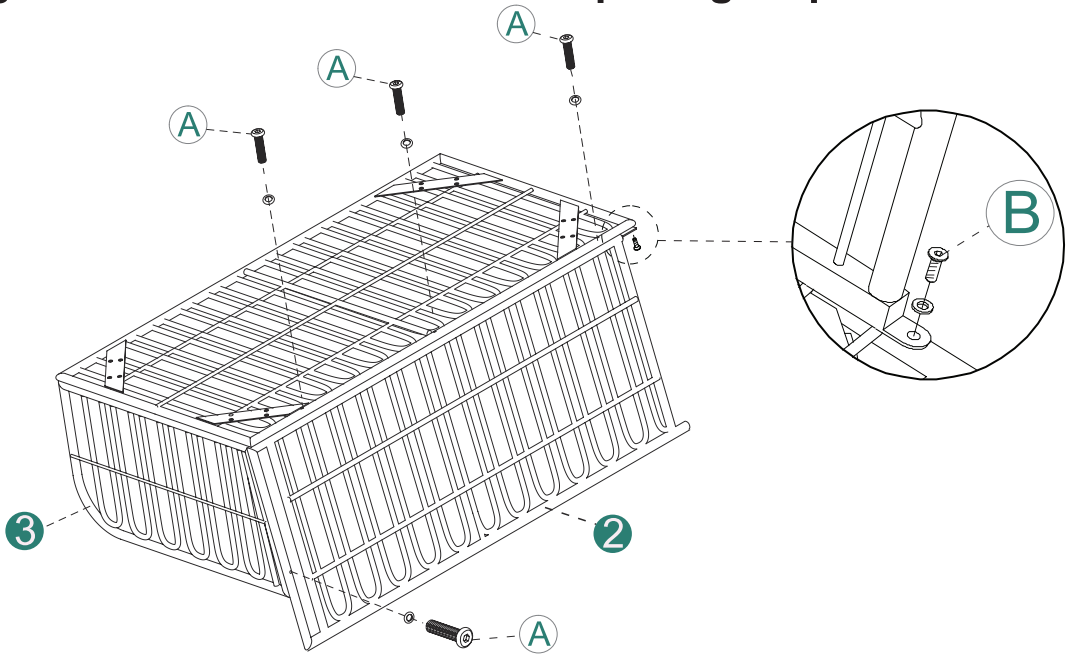

2

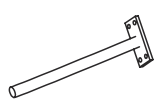

① 4pcs

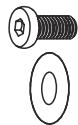

Ⓑ 16 pcs

Tighten all the screws.

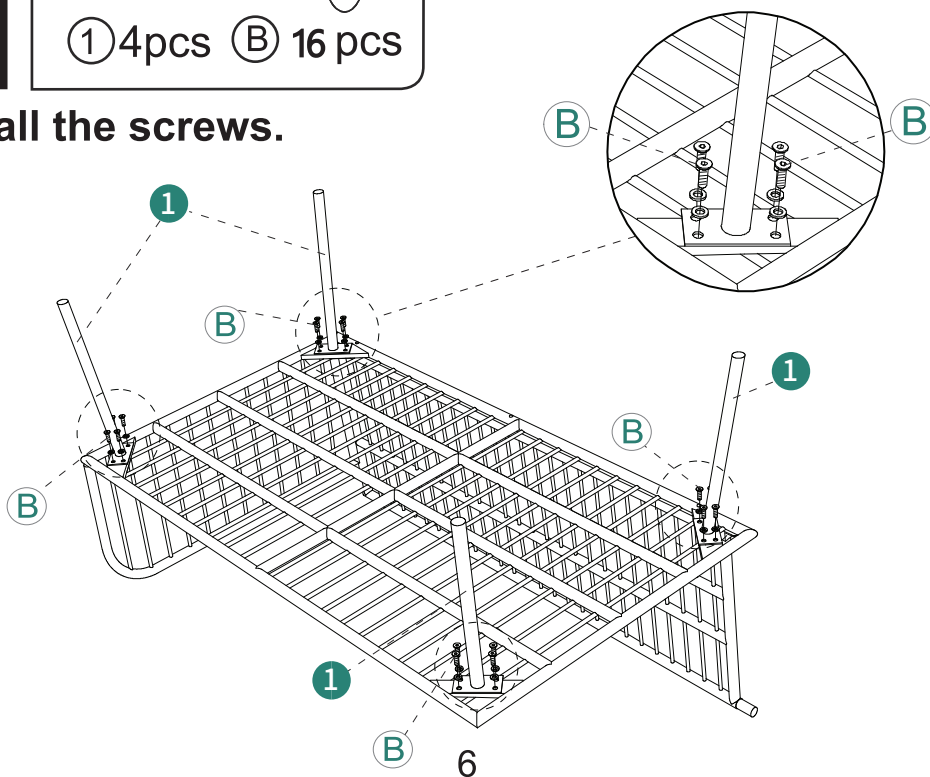

3



④ 1pc



⑤ 1pc



⑥ 1pc

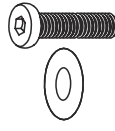

Ⓐ 5pcs

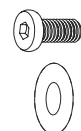

Ⓑ 2 pcs

Do not tighten all the screws until completing step 4.

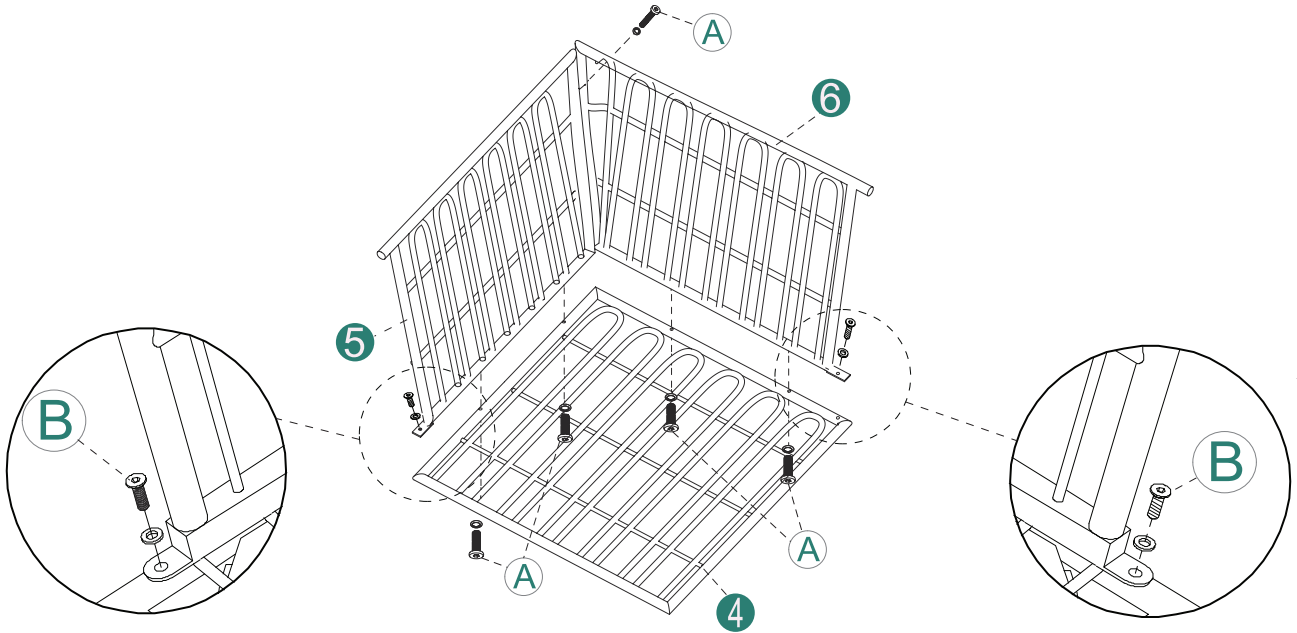

4

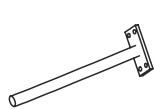

① 4pcs

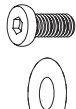

Ⓑ 16 pcs

Tighten all the screws.

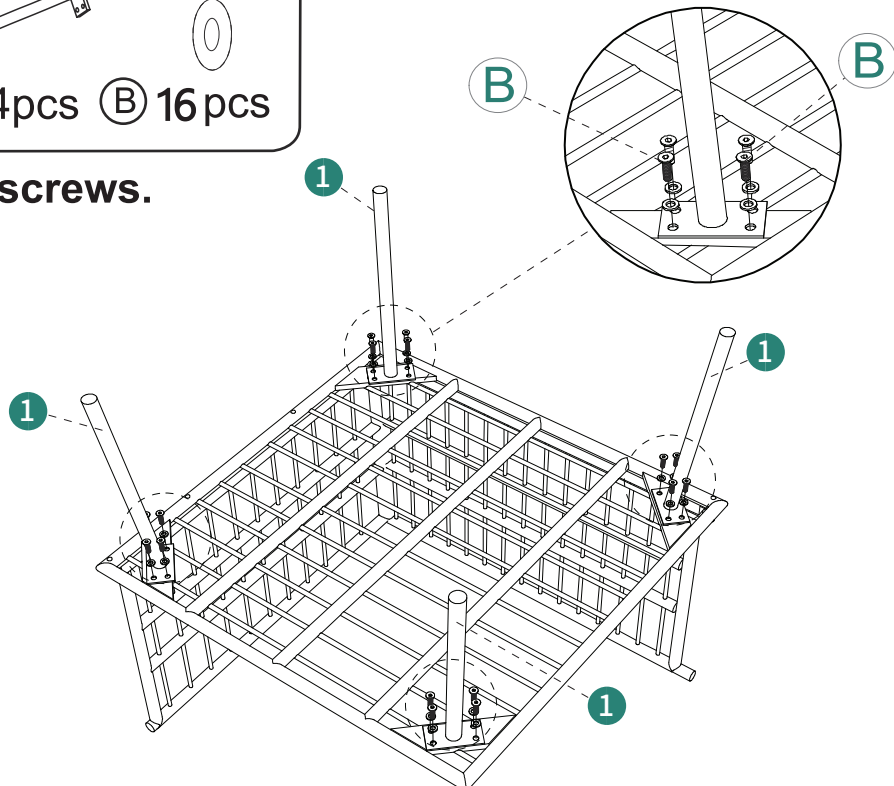

5

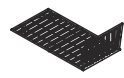

⑦ 1pc

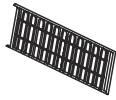

⑧ 1pc

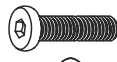

Ⓐ 4pcs



Ⓑ 1 pc

Do not tighten all the screws until completing step 6.

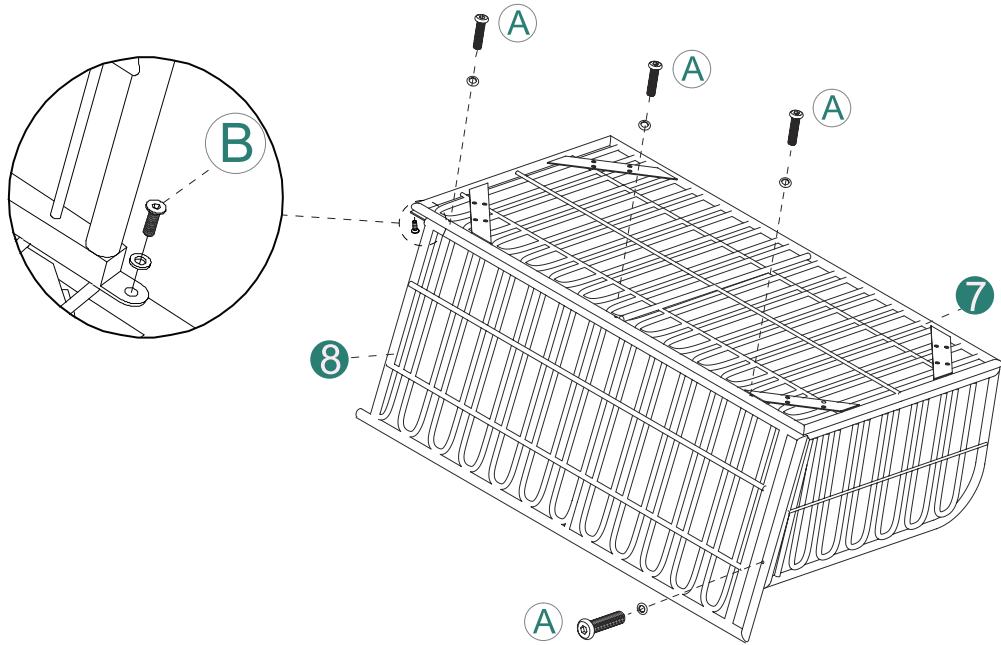

6

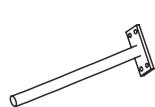

① 4pcs



Ⓑ 16 pcs

Tighten all the screws.

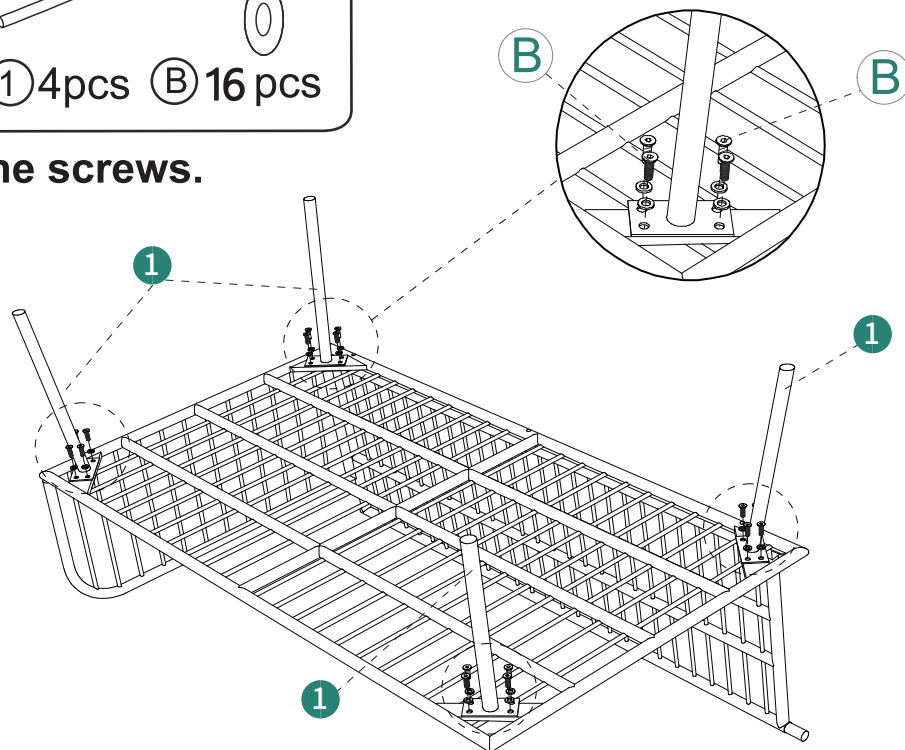

7

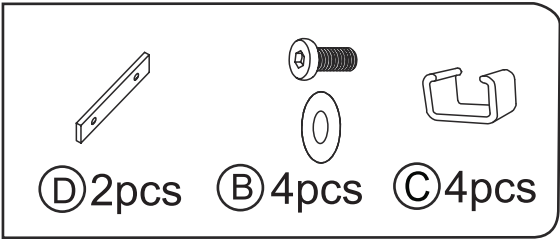

Tighten all the screws.

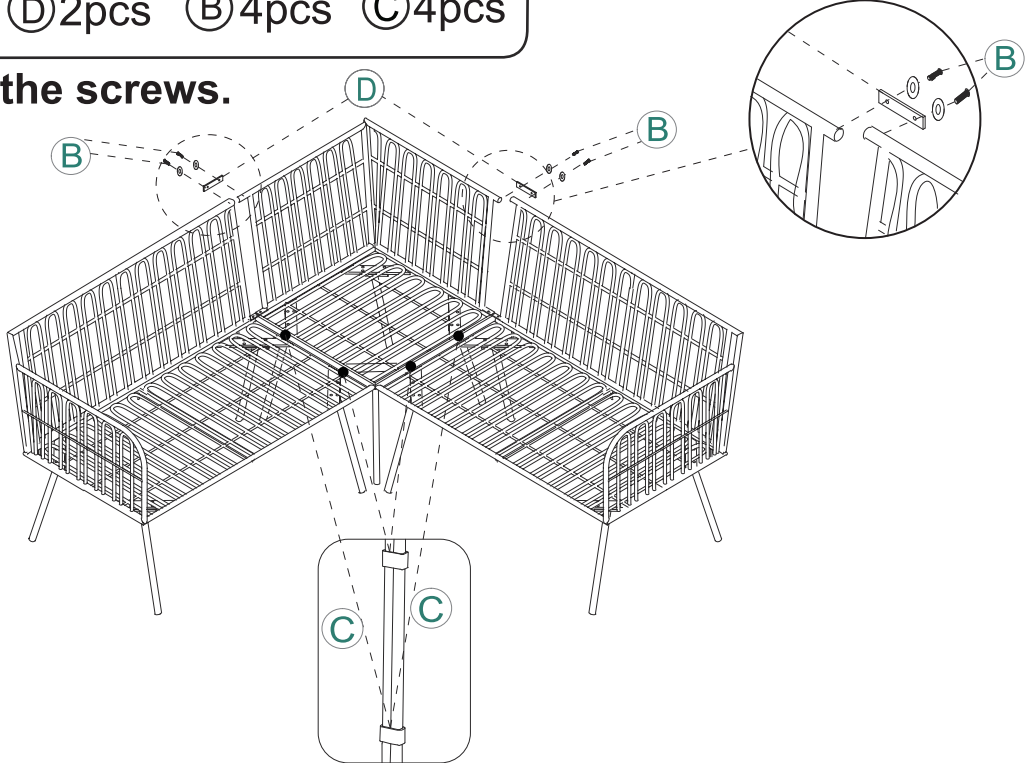

8

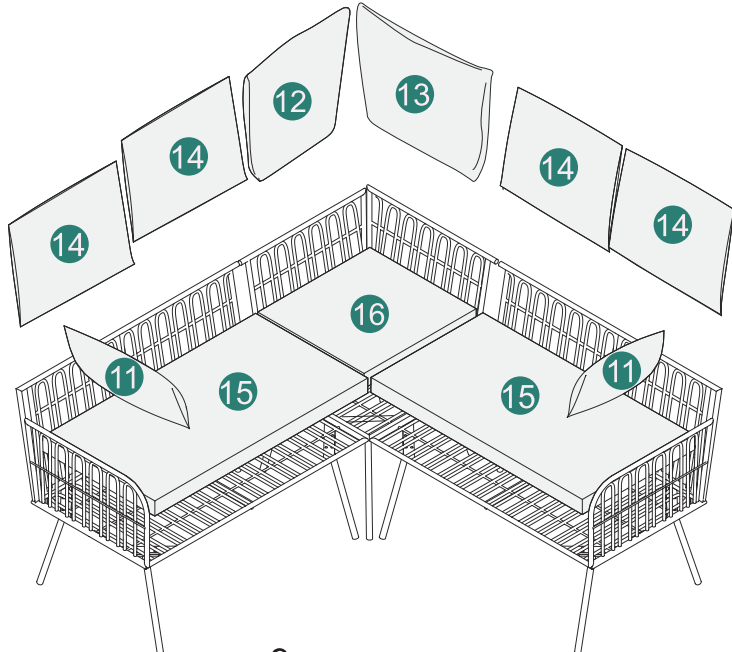
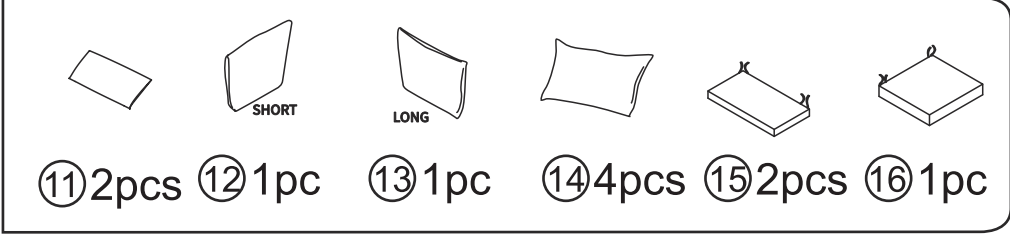

9

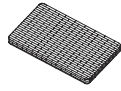

⑨ 1pc



⑩ 4pcs



Ⓑ 16pcs

Tighten all the screws.

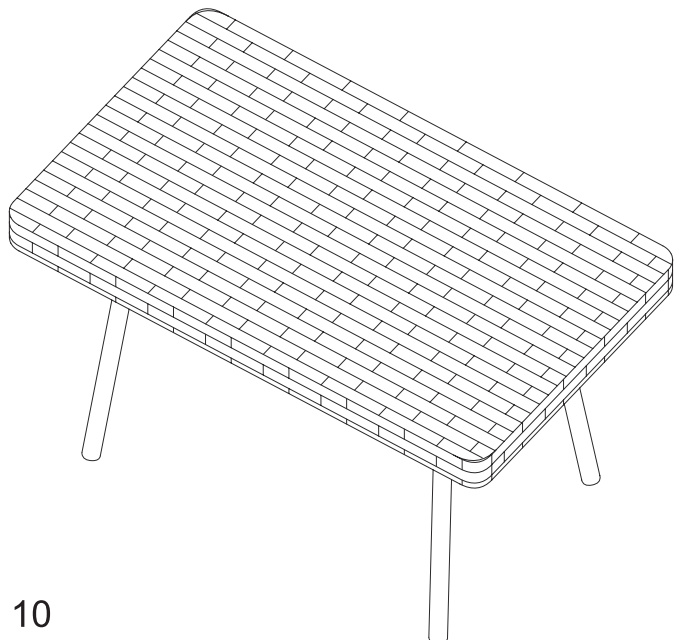
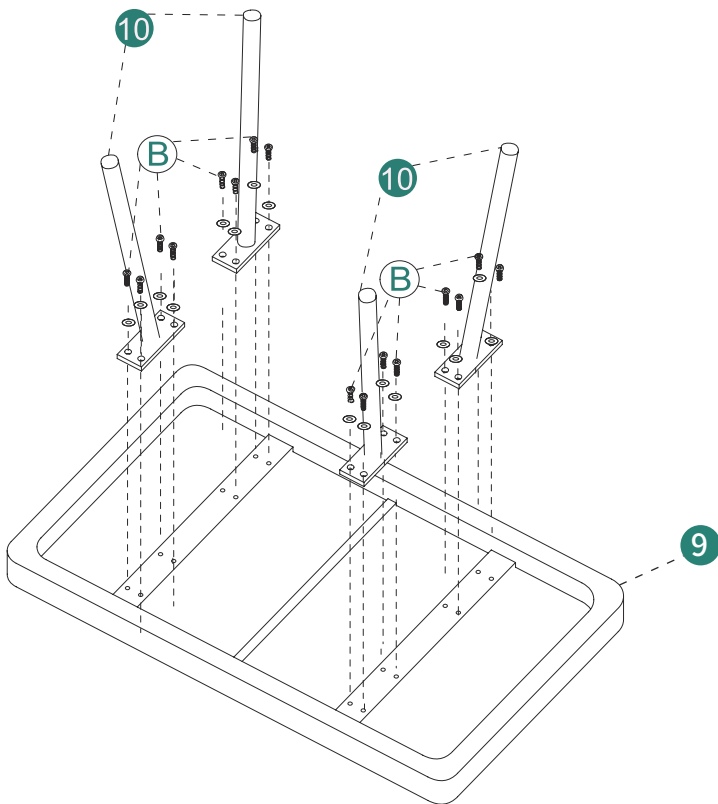

10

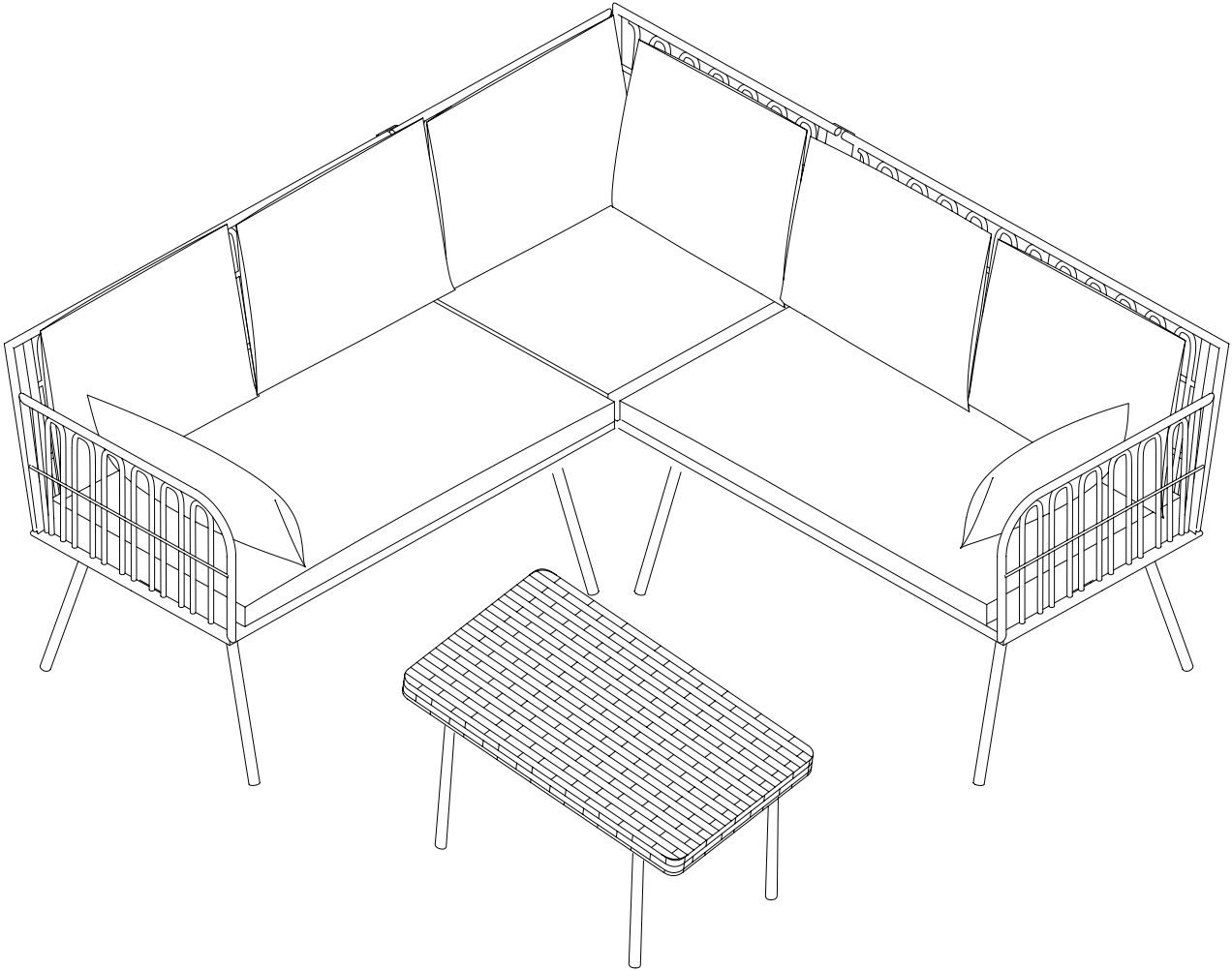

Installation Completed

Installation Abgeschlossen

Installation Complétée

Installazione Completata

Instalación Completada

HELP CENTER



Inquiry



Assembly issue



Missing parts

If you encounter any difficulties during assembly, please contact us.

Wenn Sie während der Montage auf Schwierigkeiten stoßen, kontaktieren Sie uns bitte.

Si vous rencontrez des difficultés lors du montage, veuillez nous contacter.

Se incontri difficoltà durante il montaggio, ti preghiamo di contattarci.

Si encuentras alguna dificultad durante el ensamblaje, por favor contáctanos.

DISCLAIMER

Manufacturer and seller expressly disclaim any and all liability for personal injury, property damage or loss, whether direct, indirect, or incidental, resulting from the incorrect attachment, improper use, inadequate maintenance, unapproved modification, or neglect of this product.

Der Hersteller und Verkäufer lehnen ausdrücklich jegliche Haftung für Personenschäden, Sachschäden oder Verluste ab, egal ob direkt, indirekt oder zufällig, die durch falsche Anbringung, unsachgemäßen Gebrauch, unzureichende Wartung, nicht genehmigte Änderungen oder Vernachlässigung dieses Produkts entstehen.

El fabricante y vendedor renuncian expresamente a toda responsabilidad por lesiones personales, daños materiales o pérdidas, ya sean directos, indirectos o incidentales, derivados de la incorrecta colocación, uso inadecuado, mantenimiento insuficiente, modificación no aprobada o negligencia de este producto.

Il produttore e il venditore declinano espressamente ogni responsabilità per lesioni personali, danni materiali o perdite, dirette, indirette o incidentali, derivanti dall'errato assemblaggio, uso improprio, manutenzione inadeguata, modifica non autorizzata o negligenza di questo prodotto.

Le fabricant et le vendeur déclinent expressément toute responsabilité en cas de blessures corporelles, de dommages matériels ou de pertes, qu'ils soient directs, indirects ou accessoires, résultant de la fixation incorrecte, de l'utilisation inappropriée, de l'entretien insuffisant, de la modification non approuvée ou de la négligence de ce produit.