

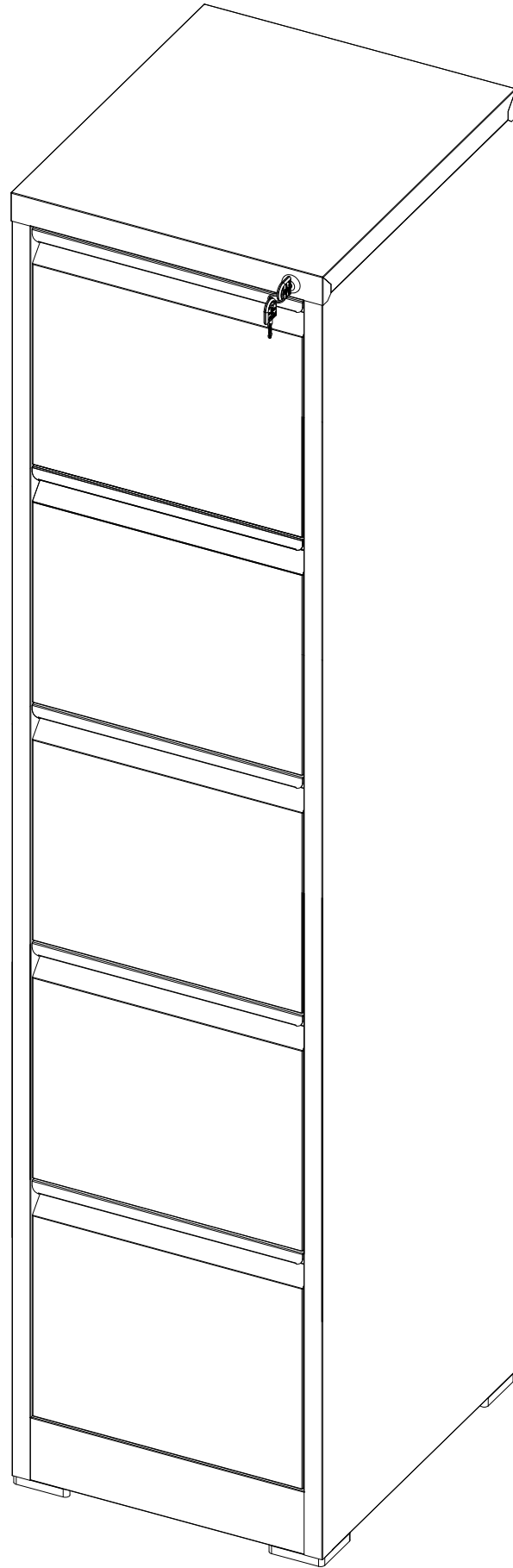

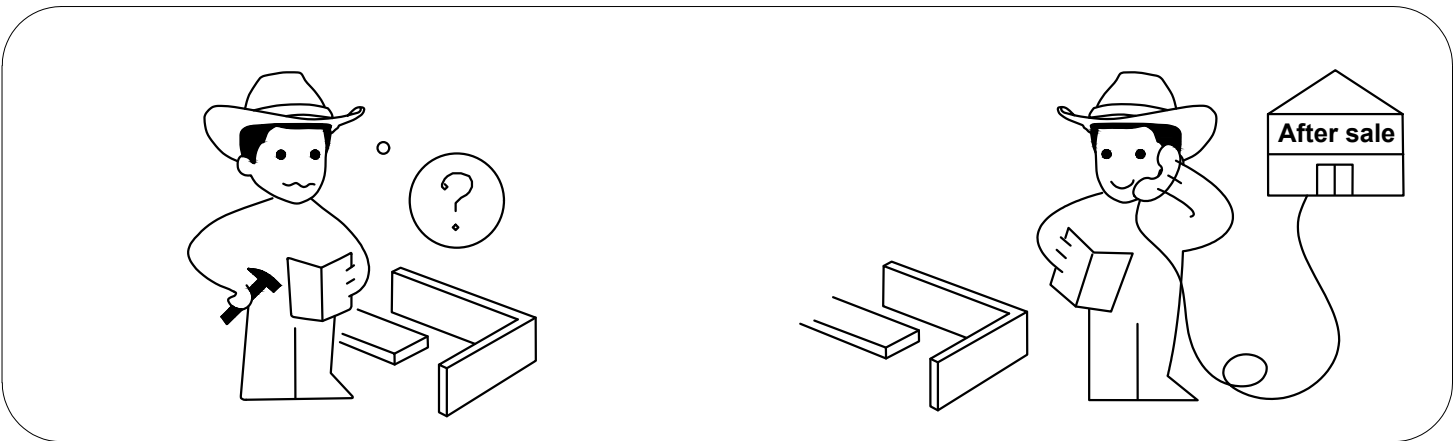

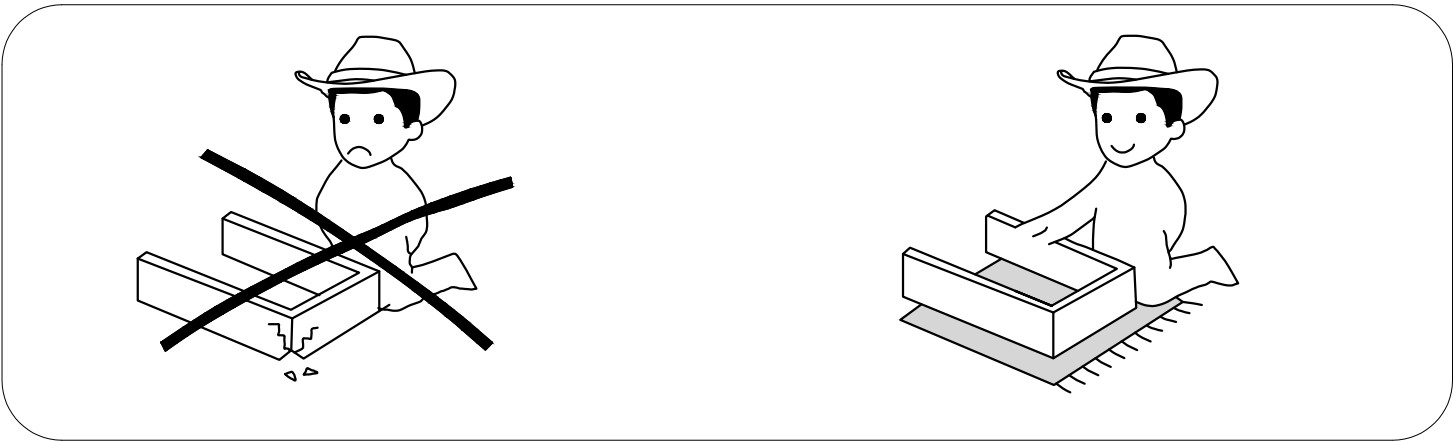

Installation & Assembly

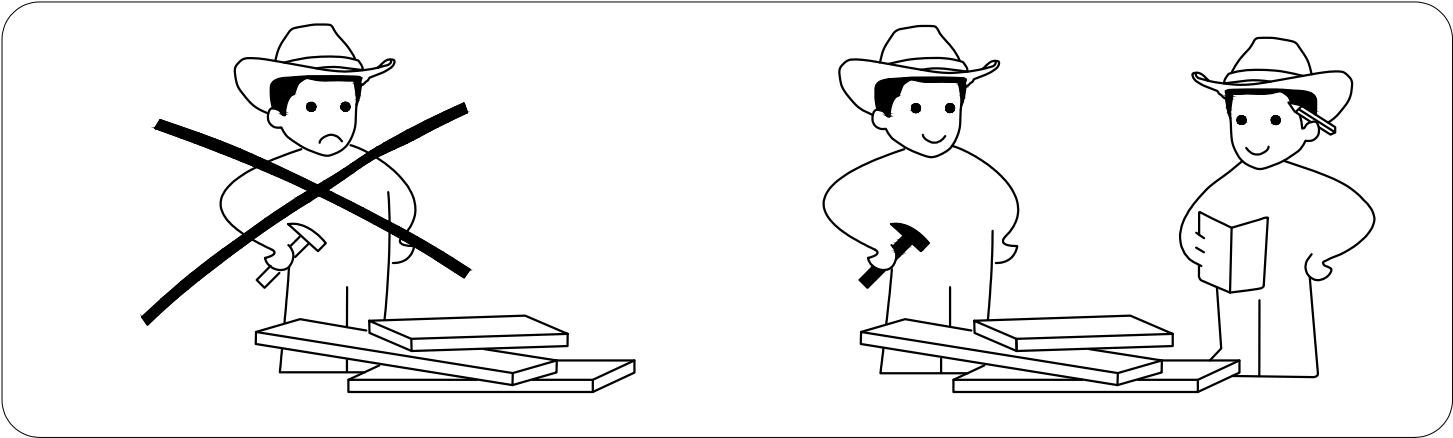
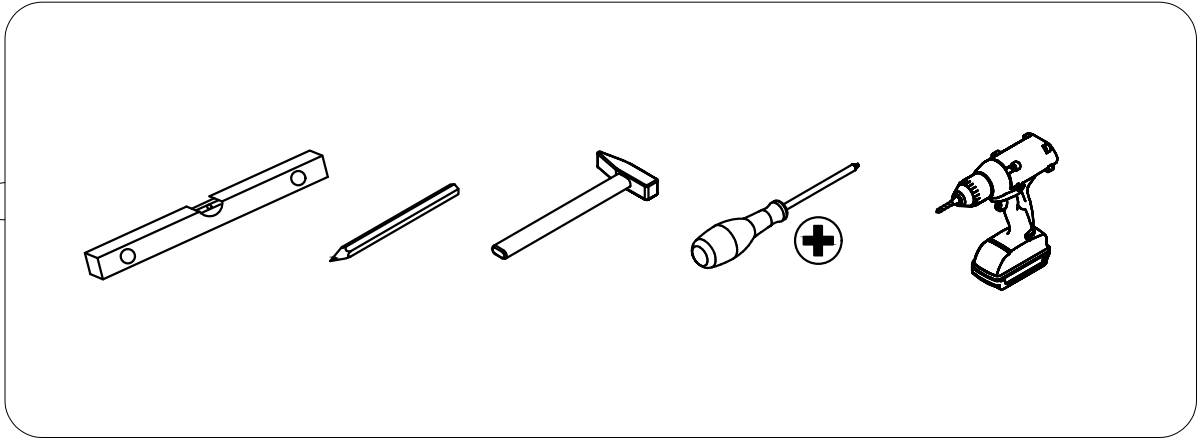
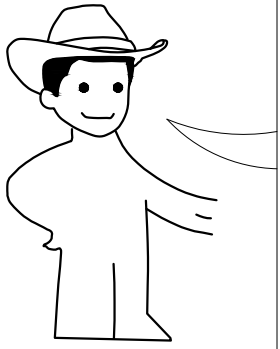
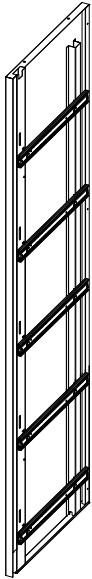
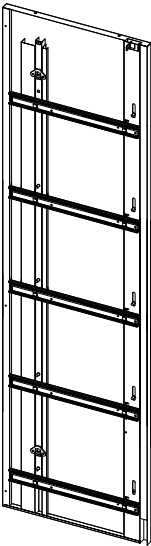
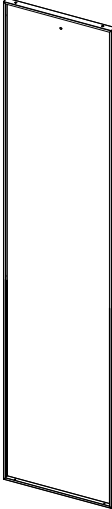
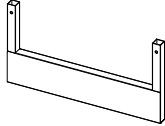
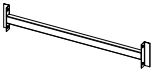
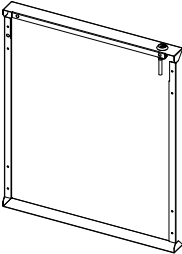
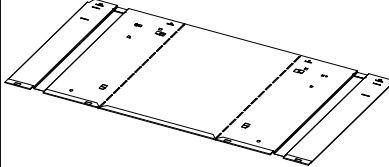
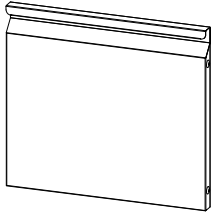
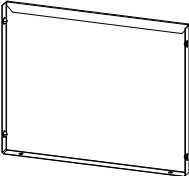

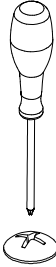

1×1pc		2×1pc		3×1pc		4×1pc	
							
5×2pcs		6×1pc		7×5pcs		8×5pcs	
							
9×5pcs		10×5pcs					
							
A×50pcs	B×12pcs	C×4pcs	D×1pc				
							
M4× 8mm 0.3inch	M5× 12mm 0.47inch						

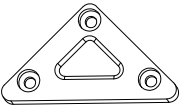
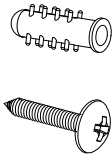
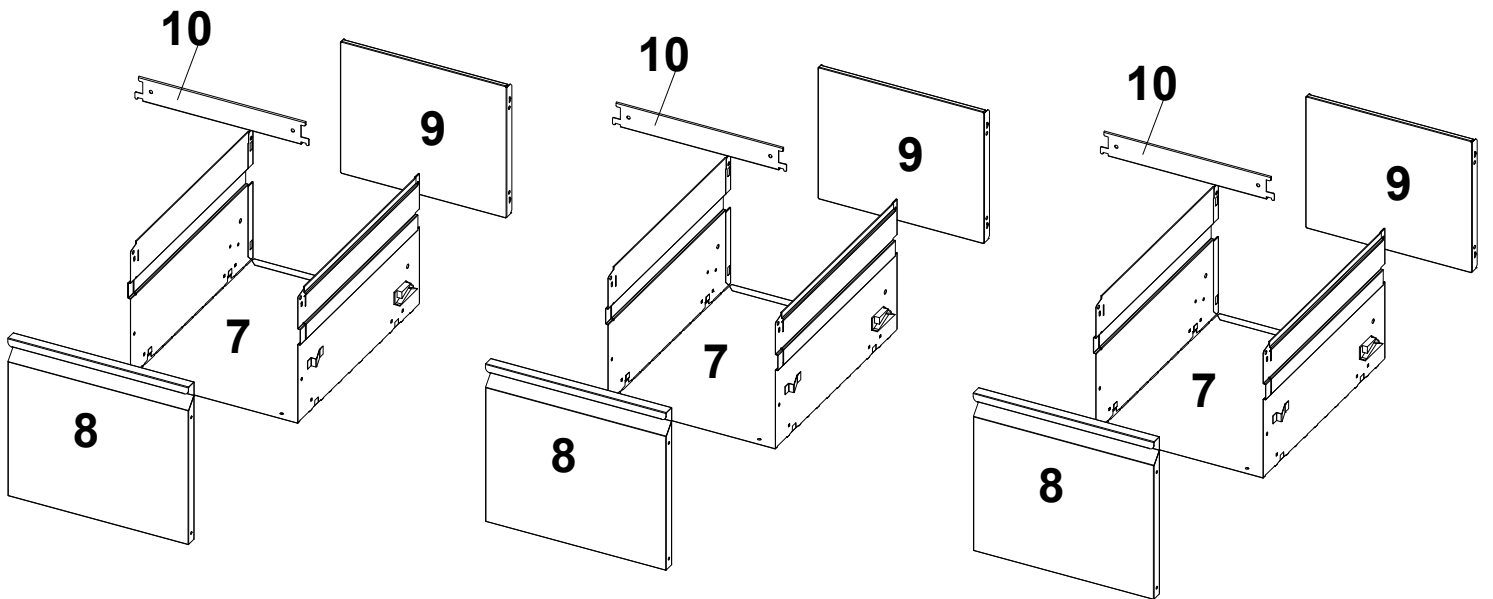
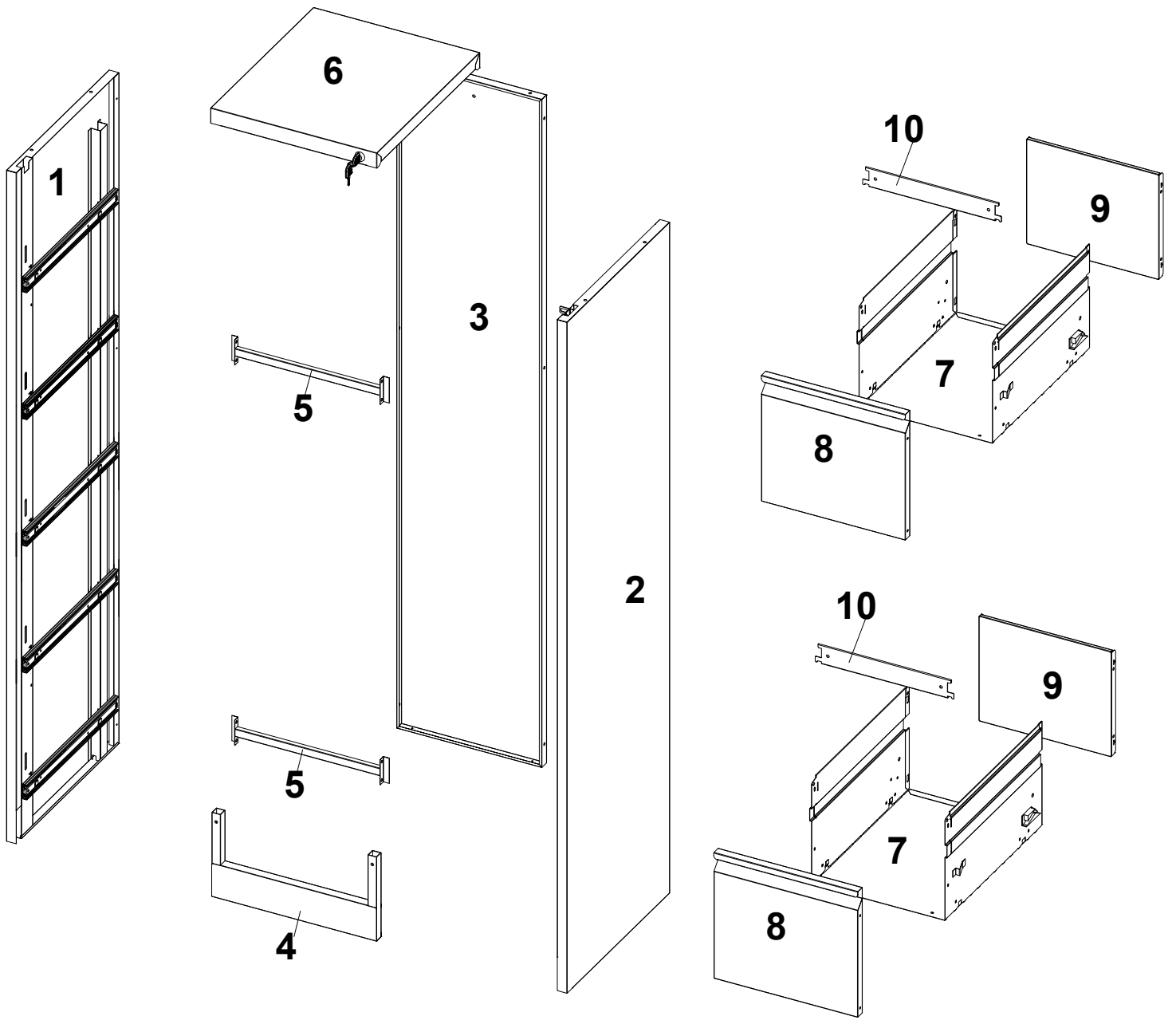

1

Put three screws to hold part 1 and 3 into place

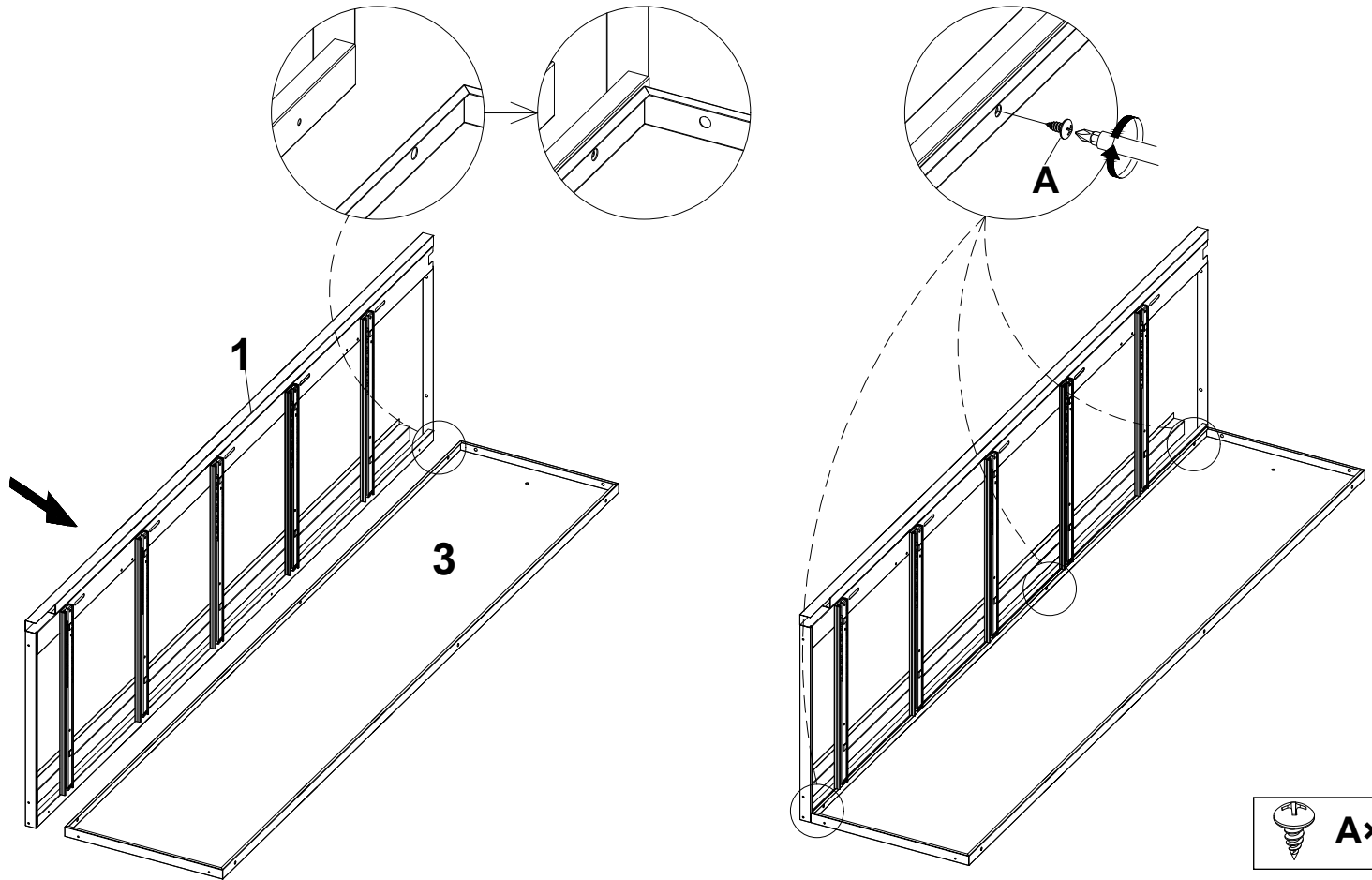

2

Put three screws to hold part 2 and 3 into place

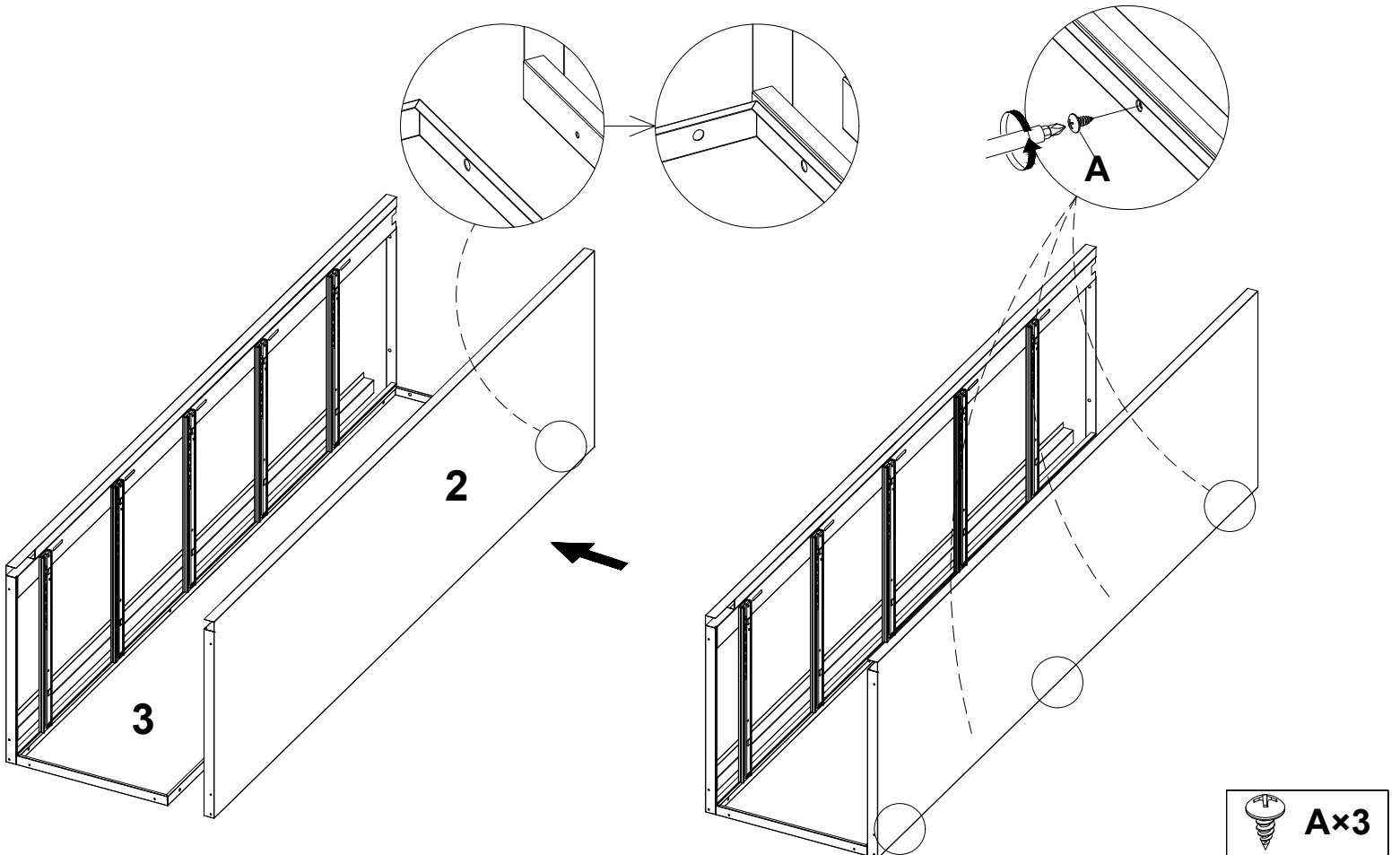

3

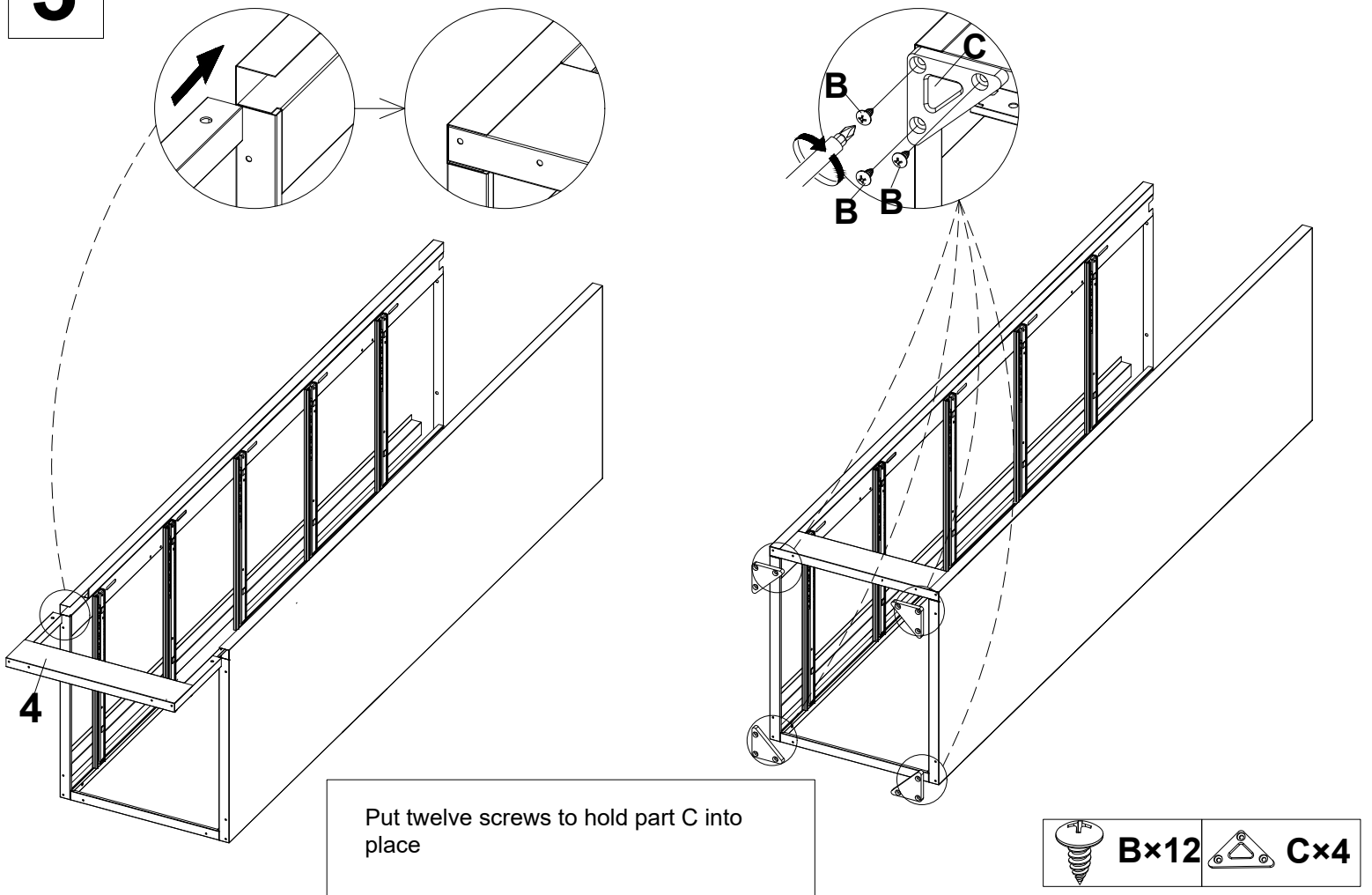

Put twelve screws to hold part C into place

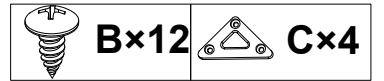

4

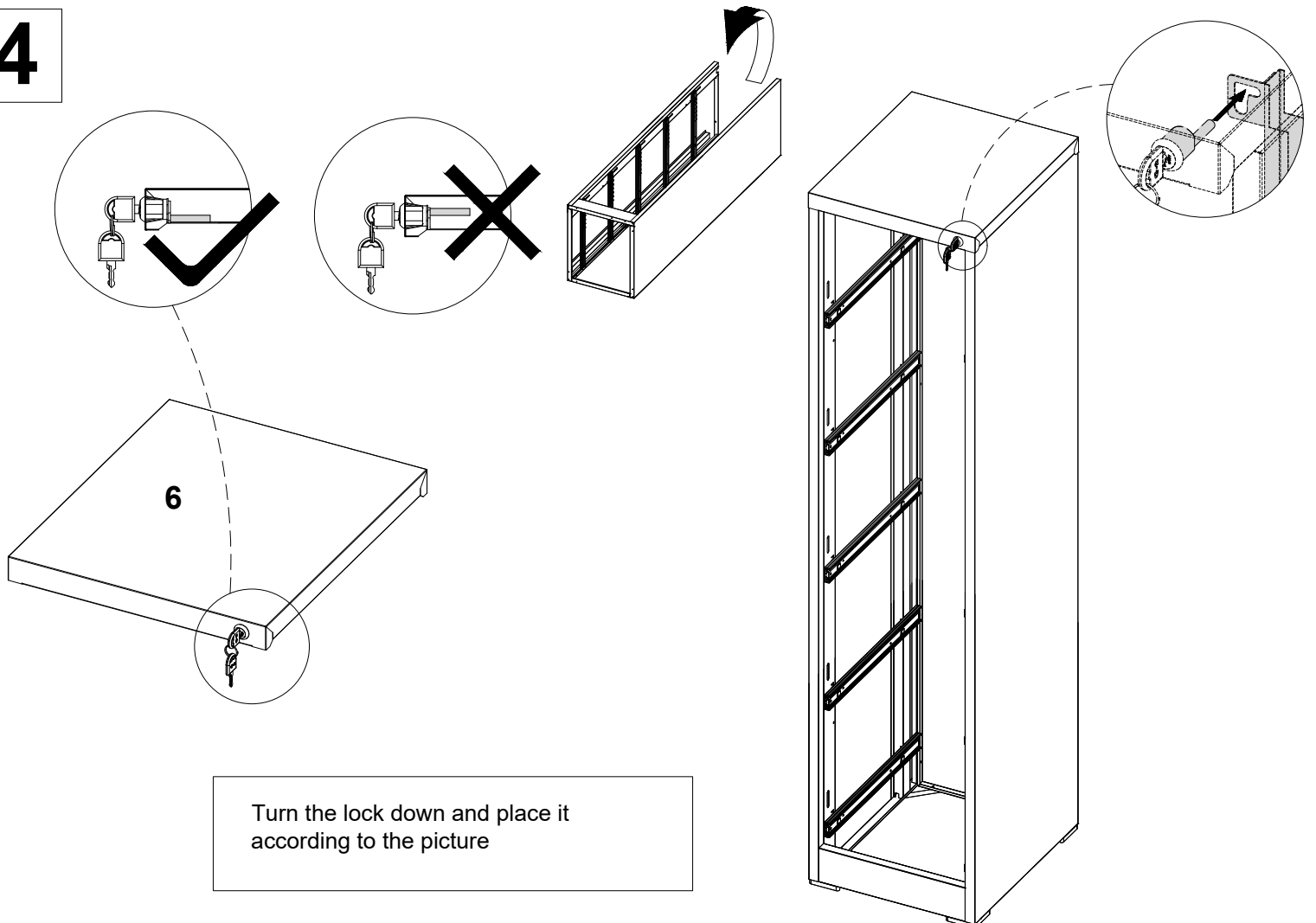

Turn the lock down and place it according to the picture

5

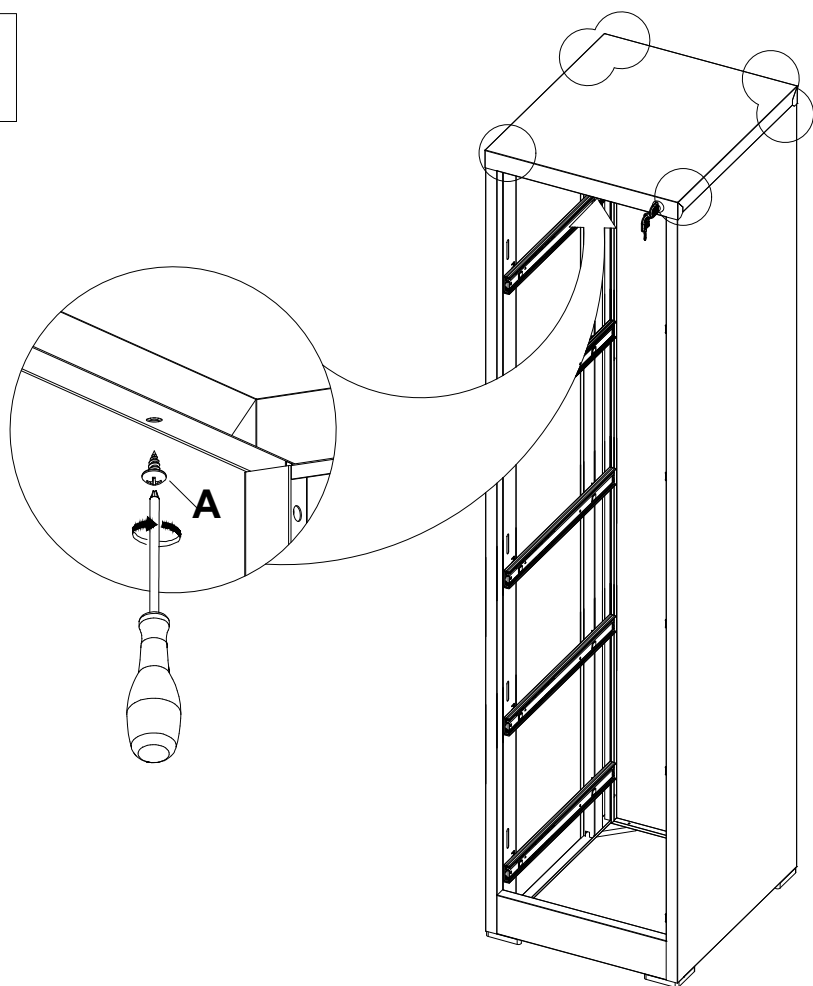

6

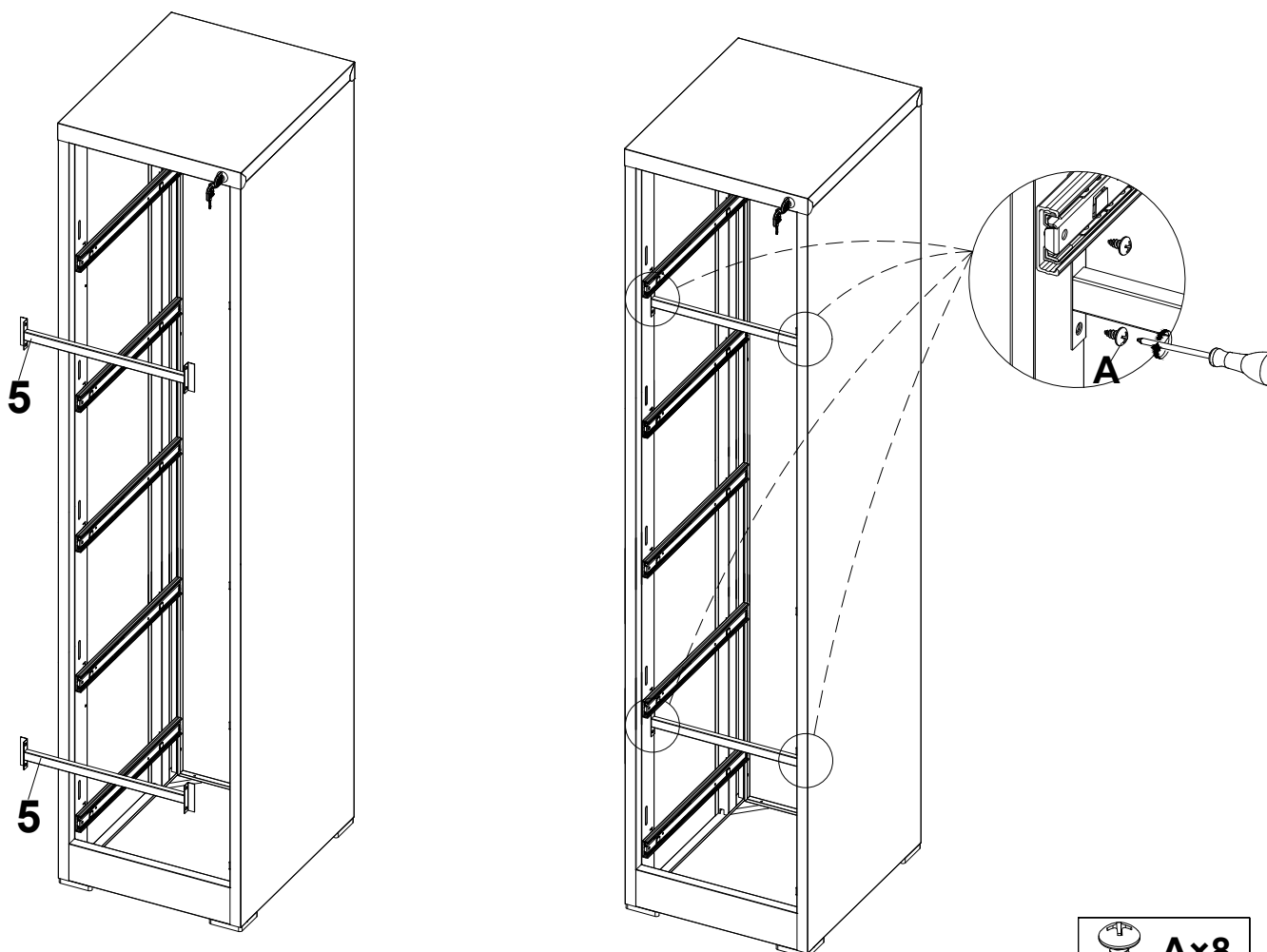

7



Suggest Fix the Cabinet to the Wall by following Step, more Stable

back

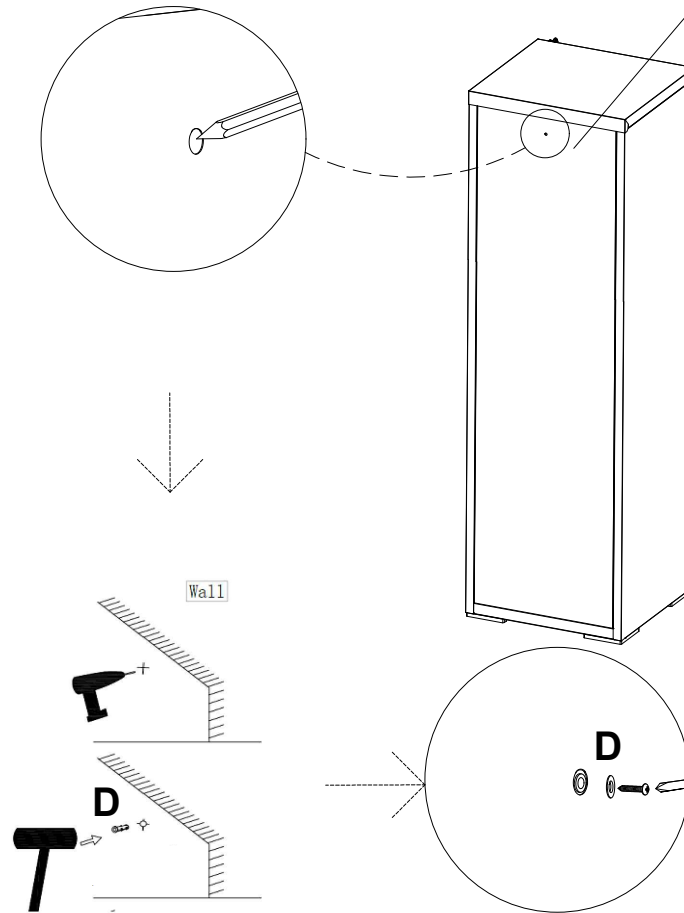

8

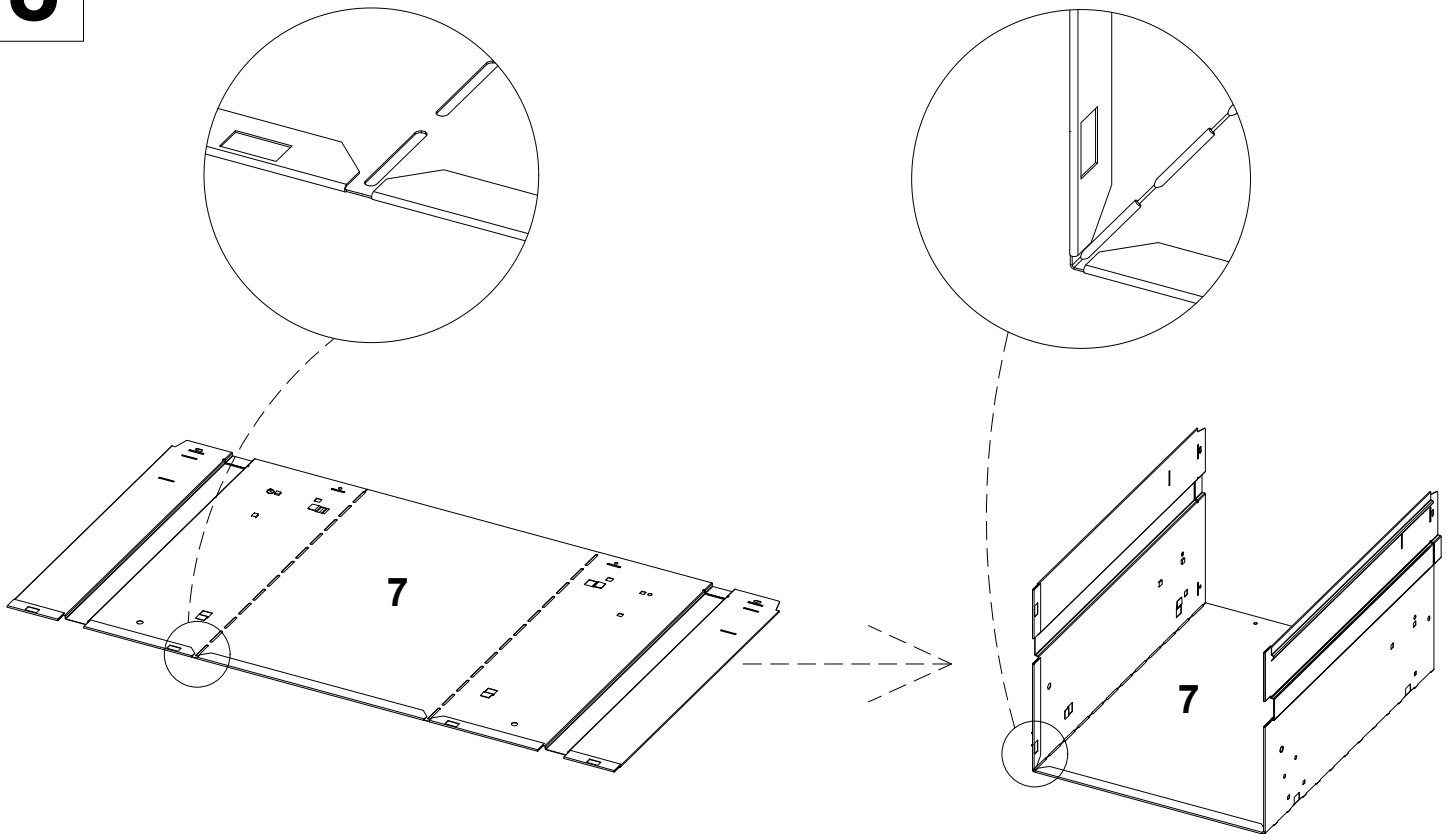

Bend the side walls of the drawer to vertical

9

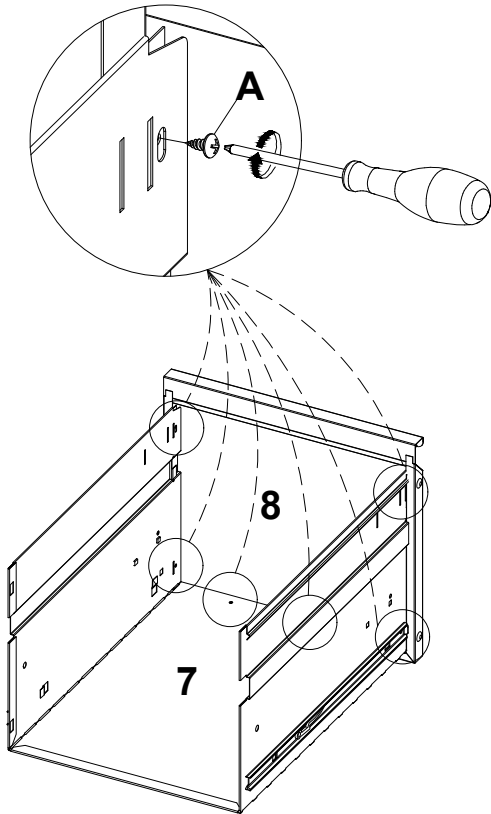

Put six screws to hold part 8 into place

Tap lightly Rear plug

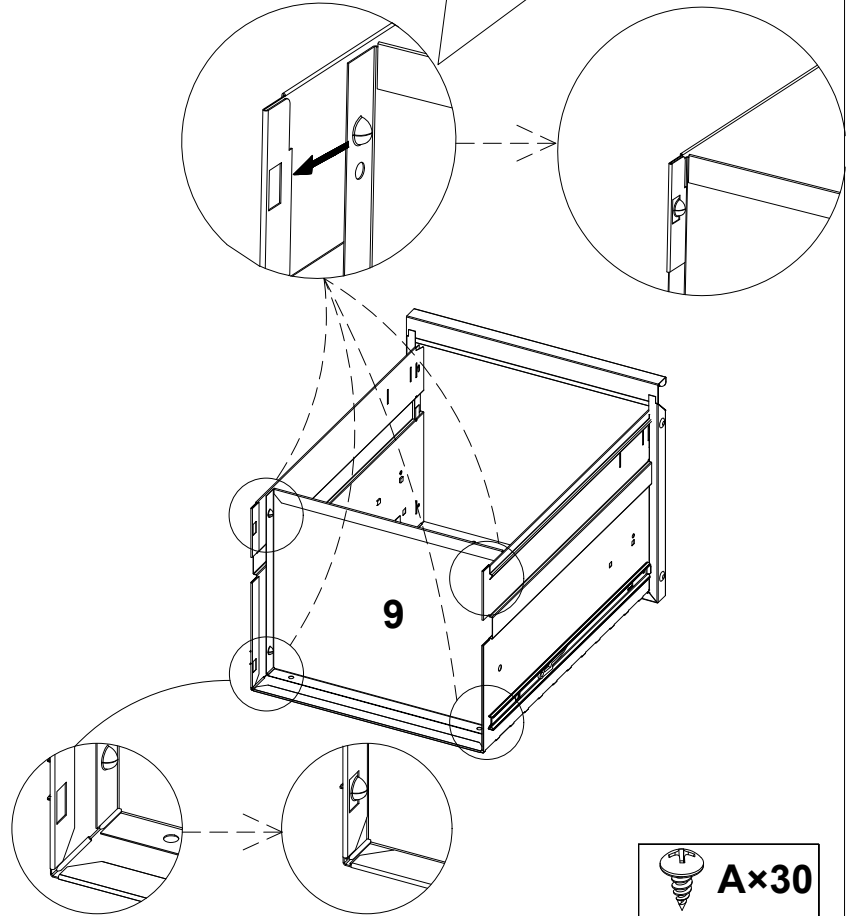

10

The file hanging bar can be put inside

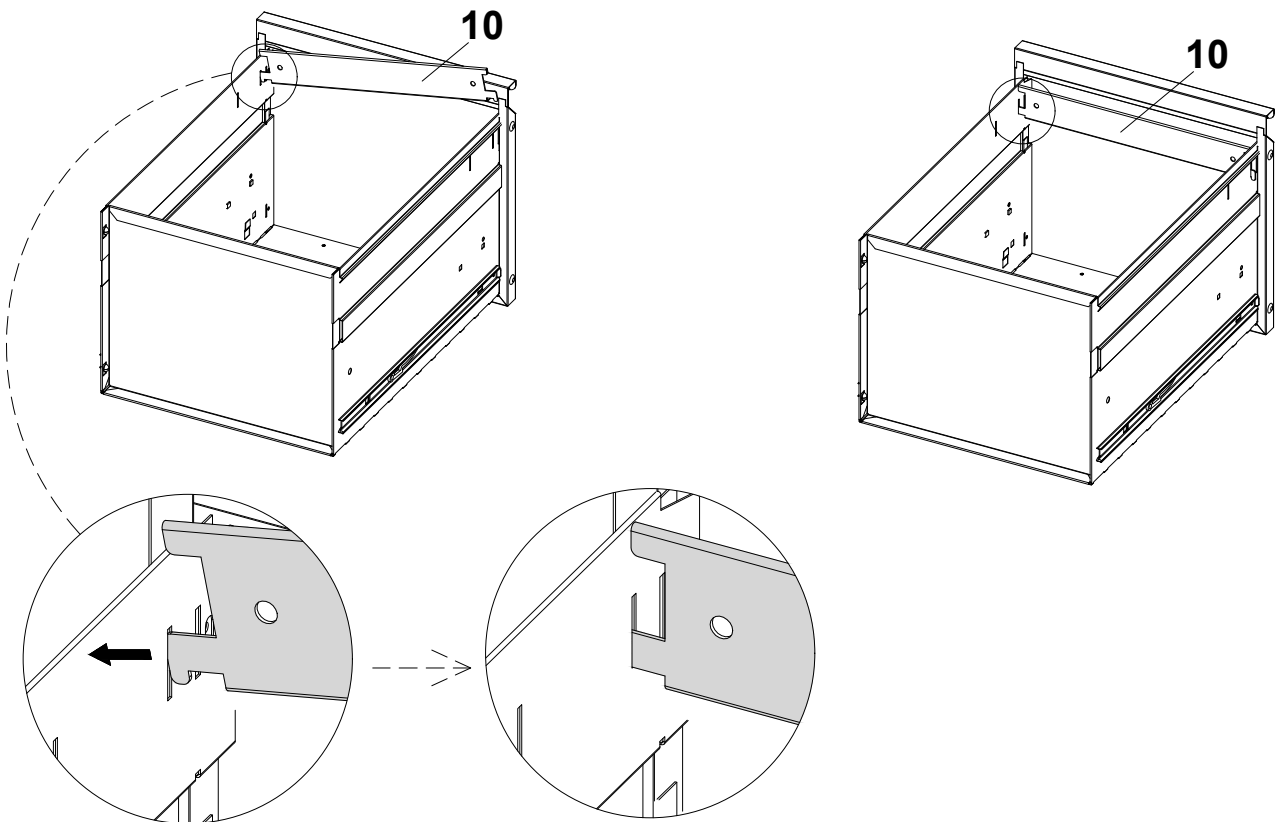

11

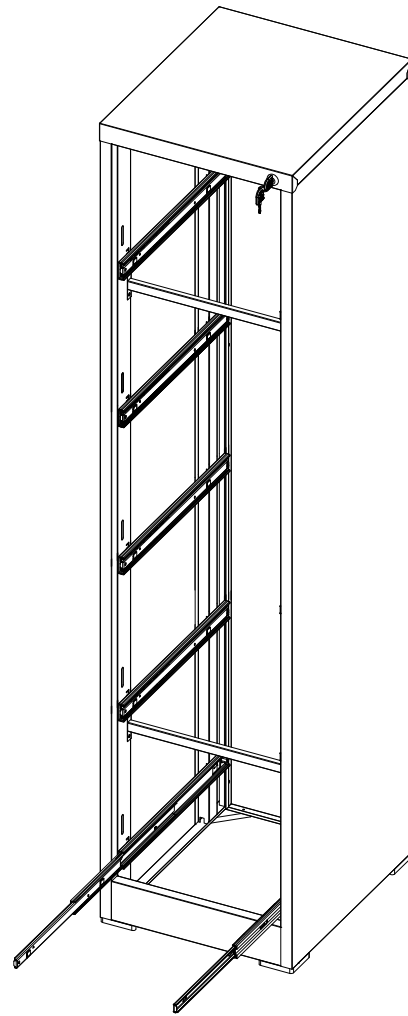
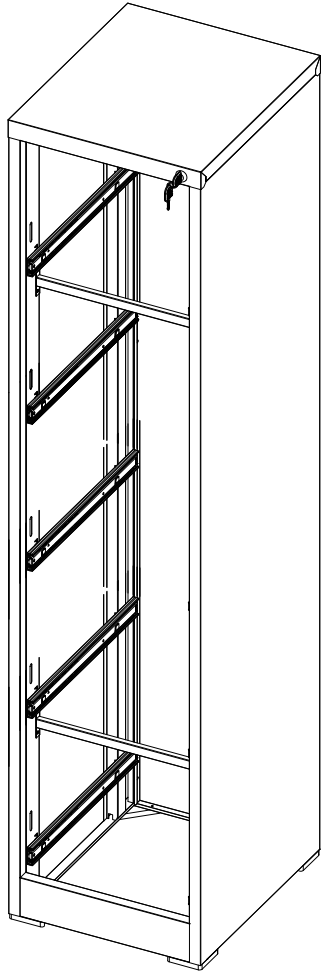

12

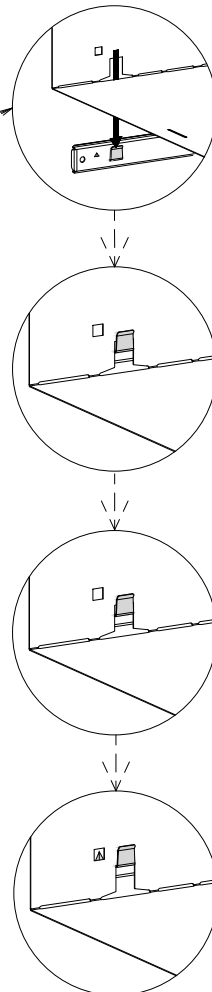
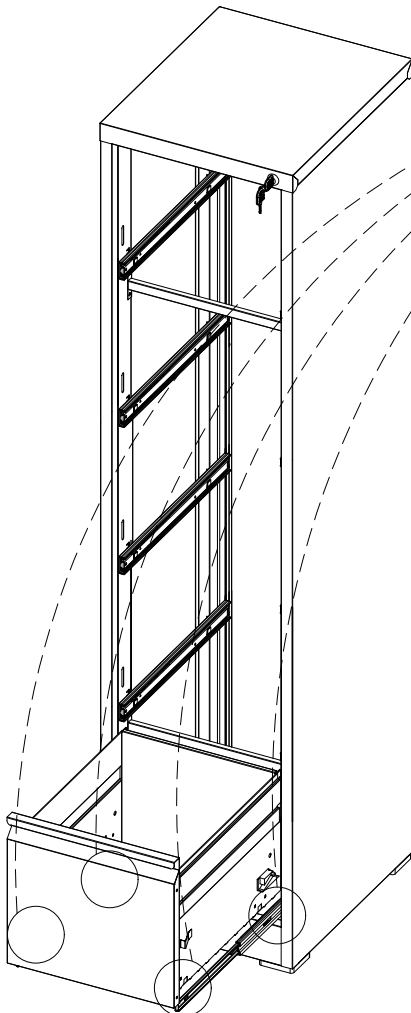

1. Pull out the small rails in the slide rails on the side walls completely. with two people lifting each side of the drawer, align the four divots on the bottom with the two rail clips on the rails on each side and insert them into the rail clips
2. After placing the drawer on the rail, press the drawer base down hard enough, paying attention to check the position of the four clips inside until you hear a click four times, which means the drawer is in place

13

