

Mirror Cabinet Installation Guide

(Recessed or Wall Mounted Installation)

For Models:

Orsa MC1-R-24

Orsa MC1-R-36

Shira MC1-AR-40X18

Ruma MC1-PL-32X16

Ezri MC1-SQ-32X24

Ezri MC2-SQ-32X36

Ezri MC3-SQ-32X48

GLASSWAREHOUSE

Before You Begin

Caution: Risk of personal injury. Cabinets are very heavy. Get assistance for lifting and moving the cabinets



NOTICE: Risk of property or product damage. The location of the cabinet is critical. Make sure that the door will clear all obstacles (such as a faucet or light fixture). Ensure that any obstacles behind the finished wall will not be damaged during the cutting and/or drilling process.

IMPORTANT! Reroute any electrical wires or water supply piping from the wall cavity. If you encounter drain or vent piping or if your wall is load-bearing, consult a professional before proceeding.

NOTE: Recessed-Mount Installation: The wall cavity must be framed. The cabinet must be secured to the framing studs.

- Observe all local building codes.
- The appearance of your recessed cabinet may differ from the recessed cabinet illustrated. The installation steps still apply.
- This installation is easiest when performed by two people.
- When determining the height of the product, verify that the doors will clear all obstacles (such as a faucet or light fixture). A minimum distance of 3" (76 mm) is required.

Tools and Materials

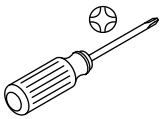
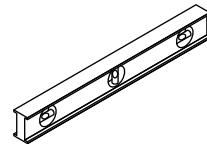
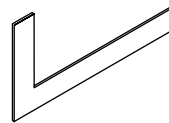
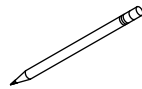
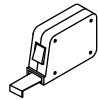
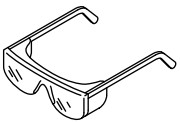

Stud
Finder

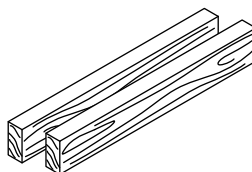

2x4 Lumber

Plus:

- Wire Cutter/Stripper
- Assorted Drill Bits
- Framing and Drywall Tools
- Framing and Drywall Fasteners

Thank you for your purchase.

If for any reason you are having trouble with installation, or if the size of the product does not fit your designated space, please contact Glass Warehouse directly and do not return this product to place of purchase. We will be able to exchange the panels or parts to suit your opening.

Glass Warehouse takes pride in providing quality products and customer service. We want to ensure your happiness with your purchase for years to come. We have an extensive range of sizes, so no matter what your measurements are, Glass Warehouse can supply the panel to fit!

If you have any questions, please do not hesitate to reach out to us. Thank you again for choosing Glass Warehouse!





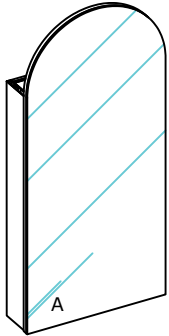

Best Regards,

The Team at Glass Warehouse
Glass Warehouse, LLC
(760) 536 3640
inquiries@glasswarehouse.us

Installation Guide

Model MC1-AR-18X40 (W: 18" / H: 40" / 1 Door)

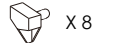



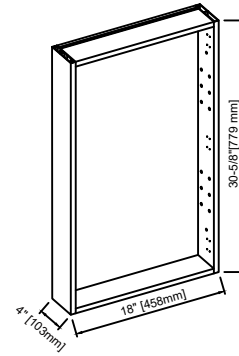

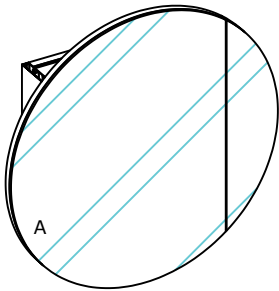

- | | | | |
|---|---|---|--|
| B |  X 8 | C |  X 12 |
| D |  X 4 | E |  X 4 |
| F |  X 2 | | |
| G |  X 8 | H |  X 3 |



Model MC1-R-24 (Dia. 24" / 1 Door)

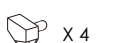



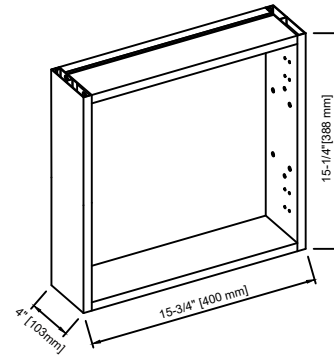

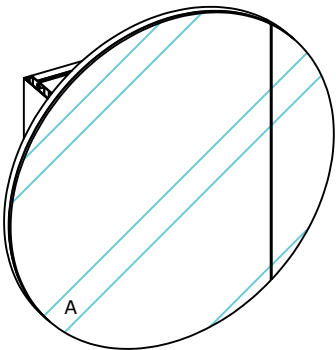

- | | | | |
|---|--|---|--|
| B |  X 8 | C |  X 12 |
| D |  X 4 | E |  X 4 |
| F |  X 1 | | |
| G |  X 4 | H |  X 2 |



Model MC1-R-36 (Dia. 36" / 1 Door)

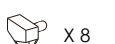

- | | | | |
|---|---|---|--|
| B |  X 8 | C |  X 12 |
| D |  X 4 | E |  X 4 |
| F |  X 2 | | |
| G |  X 8 | H |  X 3 |

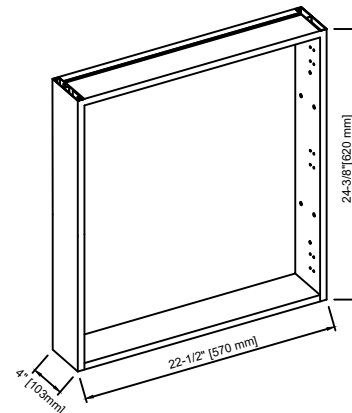

Included in your purchase

- A** Cabinet Body
- B** Flat Head Screw
- C** Decorative Sticker (For covering screw holes)
- D** Drywall Wall Plug (For Wall Mounting)
- E** Anchor for masonry (For Wall Mounting)
- F** Shelf
- G** Shelf holder
- H** Cover plate for hinge

Preparation

Measuring the cabinet body of the actual product.





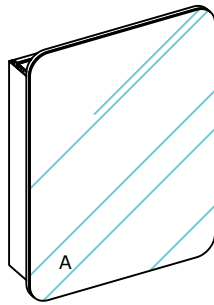

IMPORTANT:

The dimensions of the cabinet body may be vary from actual item. Please measure the exact item before making cutout.



Model MC1-SQ-24X32 (W: 24" / H: 32" / 1 Door)





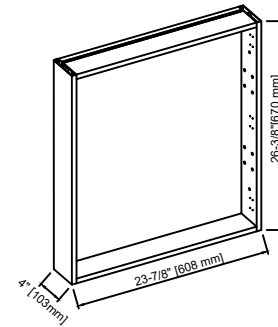

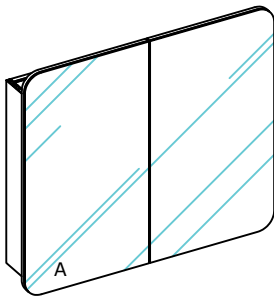

- B  X 8
- C  X 12
- D  X 4
- E  X 4
- F  X 2
- G  X 8
- H  X 3



Model MC2-SQ-36X32 (W: 36" / H: 32" / 2 Doors)





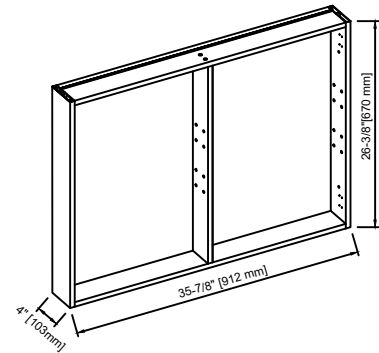

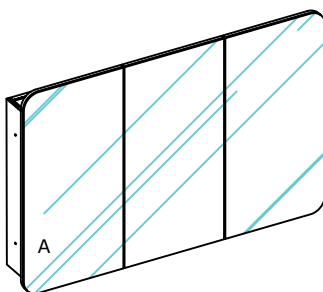

- B  X 8
- C  X 12
- D  X 4
- E  X 4
- F  X 4
- G  X 16
- H  X 4



Model MC3-SQ-48X32 (W: 48" / H: 32" / 3 Doors)



- B  X 10
- C  X 12
- D  X 6
- E  X 6
- F  X 4
- G  X 16
- H  X 6

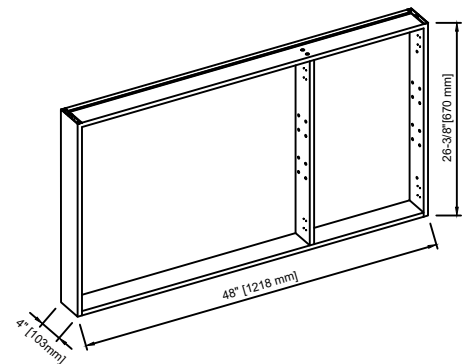

Included in your purchase

- A** Cabinet Body
- B** Flat Head Screw
- C** Decorative Sticker (For covering screw holes)
- D** Drywall Wall Plug (For Wall Mounting)
- E** Anchor for masonry (For Wall Mounting)
- F** Shelf
- G** Shelf holder
- H** Cover plate for hinge

Preparation

Measuring the cabinet body of the actual product.





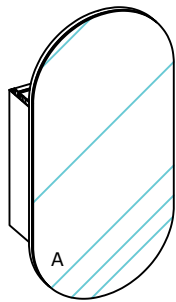

IMPORTANT:

The dimensions of the cabinet body may vary from actual item. Please measure the exact item before making cutout.



Model MC1-PL-16X32 (W: 16" / H: 32" / 1 Door)



- | | | | | | |
|---|---|-----|---|---|------|
| B |  | X 8 | C |  | X 12 |
| D |  | X 4 | E |  | X 4 |
| F |  | X 1 | | | |
| G |  | X 4 | H |  | X 2 |

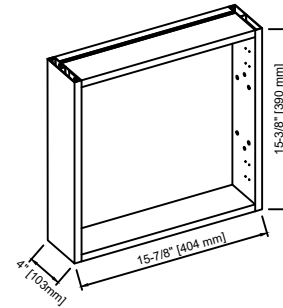

Included in your purchase

- A** Cabinet Body
- B** Flat Head Screw
- C** Decorative Sticker (For covering screw holes)
- D** Drywall Wall Plug (For Wall Mounting)
- E** Anchor for masonry (For Wall Mounting)
- F** Shelf
- G** Shelf holder
- H** Cover plate for hinge

Preparation

Measuring the cabinet body of the actual product.

IMPORTANT:

The dimensions of the cabinet body may vary from actual item. Please measure the exact item before making cutout.



Wall Mount Installation

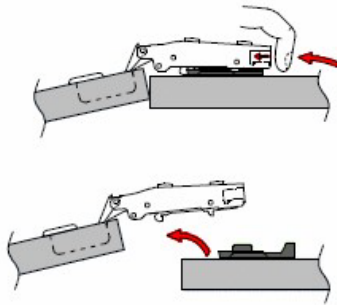
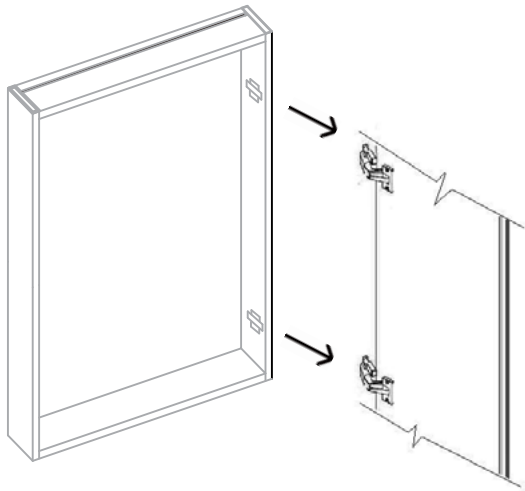

01

Disassemble the cabinet door(s)

After taking out the cabinet, disassembling the door(s).

The door(s) can be quickly removed by pushing the button on hinge.

Unclipping the door from the mounting plate.

IMPORTANT:

When determining the height of product, verify that the doors will clear all obstacles (such as a faucet or light fixture). A minimum distance of 3" (76mm) is required.



Remarks for fixing brackets:

- Timber: Locate a stud and drill holes using a 1/8" wood drill bit. Anchors are not necessary.
- Masonry: Drill holes using a 1/4" masonry drill bit. With a hammer, gently tap each Green anchor (E) into the holes until flush with the wall surface.

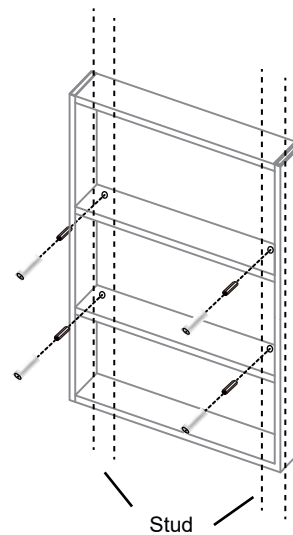
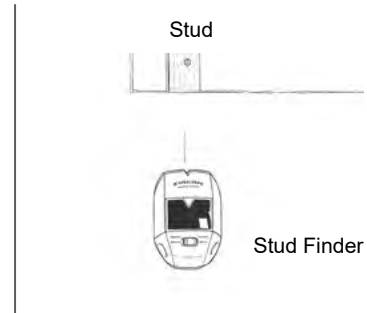

02

Mounting the Cabinet Body on wall (Please read the remarks carefully before starting)

Find a stud (use a stud finder) and mount into a stud only. If possible, screw through side of the shaving cabinet at the level where the adjustable shelves will be placed. This way the screws will be hidden by the shelves. ENSURING SCREWS ARE FIXED TO A STUD.

Install the screws (B) to fix the bottom bracket according to the remarks.

Recessed Installation

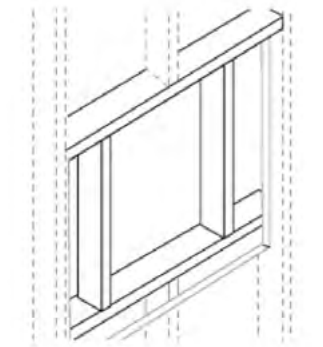
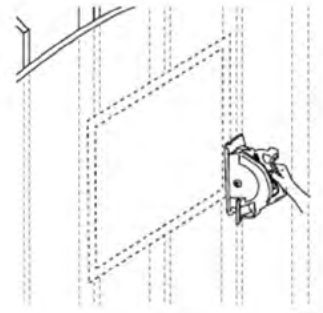
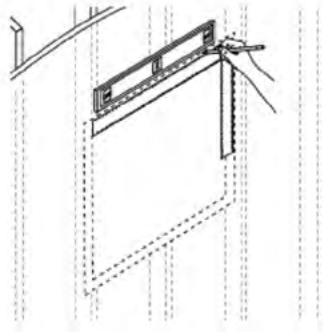

01

Construct the framing

Measuring the cabinet body of exact item.

Using a jigsaw or keyhole saw, carefully remove the finished wall material from the marked cutout.

Frame out the wall cavity. If needed, install a header.

IMPORTANT:

The dimensions of the cabinet body may vary from actual item. Please measure the exact item before making cutout.



When determining the height of the product, verify that the doors will clear all obstacles (such as a faucet or light fixture). A minimum distance of 3" (76 mm) is required.

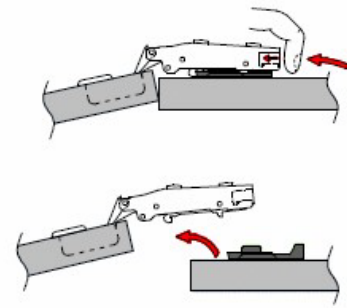
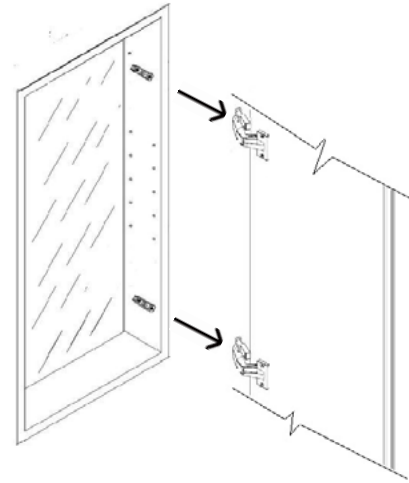

02

Disassemble the cabinet door(s)

After taking out the cabinet, disassembling the door(s).

The door(s) can be quickly removed by pushing the button on hinge.

Unclipping the door from the mounting plate.

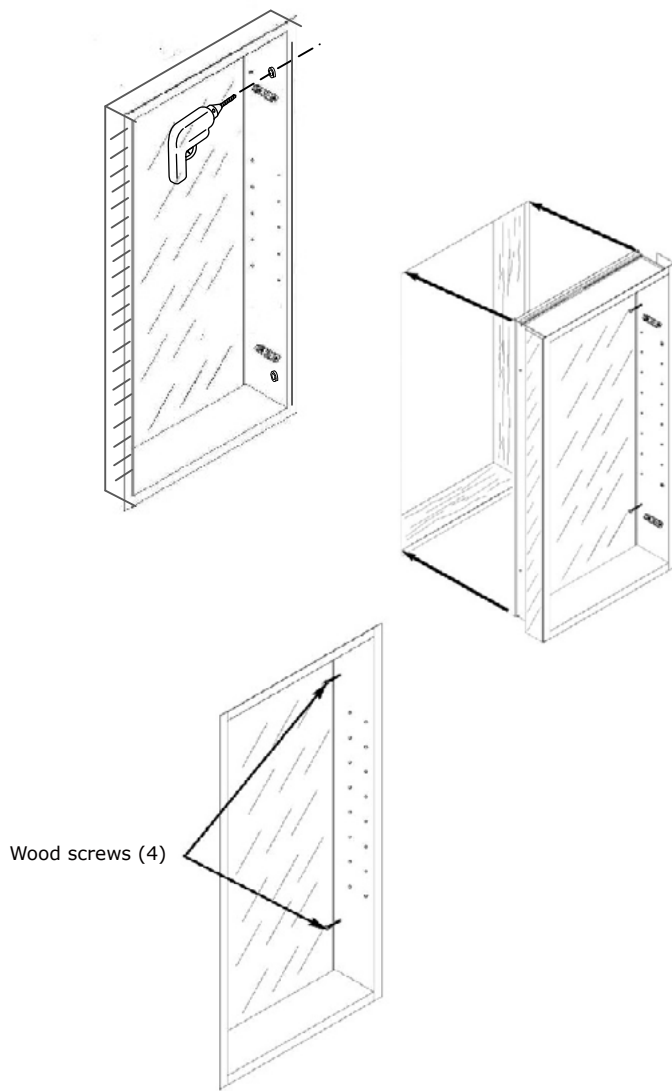

03

Install the cabinet body into the framing

Drill through the 4 Half-Drilled holes (With rivet nuts) for recessed installation by using 1/4" drill bit.

Make sure hinges are on correct side of opening for left hand or right hand operation.

Place cabinet body into framing.

Insert 4 screws (B) into four locations provided for recessed installation. Be careful not to overtighten. Make sure cabinet is centered in framing.

Important: Enclosed screws are for wooden frame only. Appropriate anchors and screws need to be purchased for installation into non wooden frames.

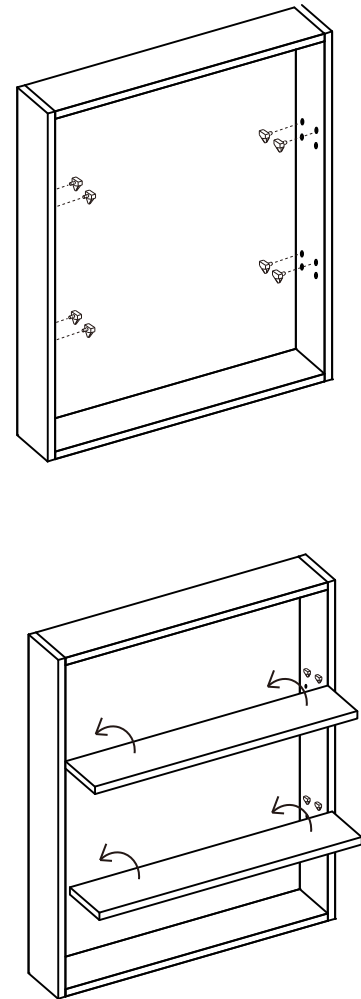

04

Install the shelf(shelves)

Determine the shelf(shelves) locations and put the shelf holders into the holes in the sides of the cabinet.

Put the shelf(shelves) on the shelf pins and make sure the shelf pins fixed into the channels at the bottom of the shlef(shelves).

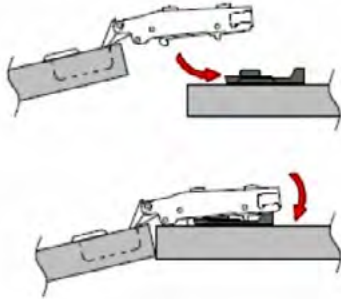
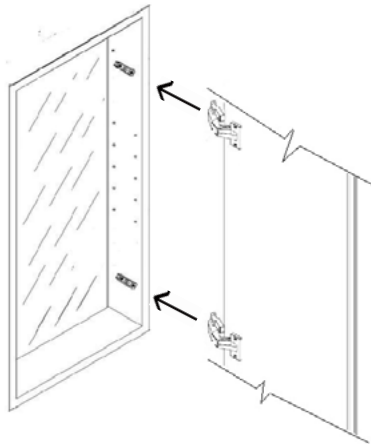

05

Reassembling the door(s)

After install the glass shelf (shelves) in right position, reassembling the door(s).

Clamp hinge on the mounting plate as shown by direction arrow.

Press down the hinge arm to lock the plate as shown.

Important: For products with more than one door, please make sure you assemble the doors in correct sides by matching the same letters stuck on the mounting plate on cabinet body and hinge arm on door.

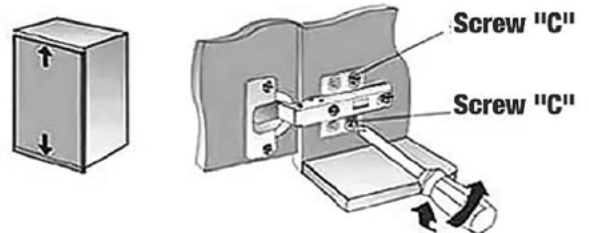
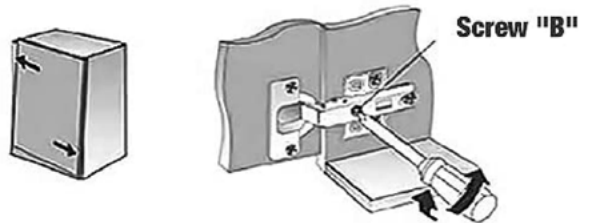
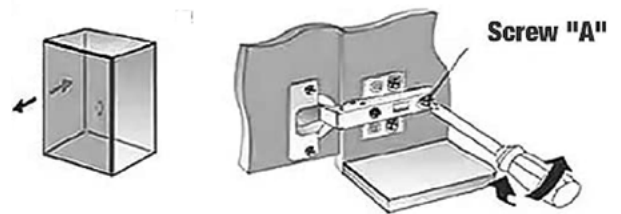

06

Adjusting hinges - To make the door(s) in correct position

Front to back adjustment - Turn the screw "A" clockwise or anti-clockwise for moving the door Inward or Outward.

Lateral adjustment - Turn the screw "B" clockwise or anti-clockwise for moving the door Left or Right.

Vertical adjustment - Turn the screw "A" clockwise or anti-clockwise for moving the door Up or Down.

Care and Cleaning

The cabinet door and interior are constructed of mirrored glass, steel and stainless steel. Use only a damp cloth to clean.

Ammonia or vinegar based cleaners can damage mirrors. A solution of 50% of water and 50% of isopropyl alcohol is recommended for mirror cleaning.

A very mild detergent may be used to clean the surface. When cleaning, spray the cloth, not the cabinet, mirror, or surround surfaces. Do not use abrasive cleansers on any part of the cabinet.



Featured Model: Esprit

GLASSWAREHOUSE
GLASSWAREHOUSE.US



Complete your kit

Explore our complete range of shower enclosures to compliment your new medicine cabinet. Choose from many different styles, finishes, and options to give your bathroom that extra bit of style.

Exclusive Limited Warranty Terms & Conditions.

This Limited Lifetime Warranty ("Warranty") is effective as of DECEMBER 6, 2024

PLEASE READ THE WARRANTY TERMS AND CONDITIONS BEFORE PURCHASING AND BEFORE INSTALLING OR RESELLING YOUR GLASS WAREHOUSE PRODUCT. BY PURCHASE, INSTALLING, AND OR RESELLING THE GLASS WAREHOUSE PRODUCT, YOU ARE CONSENTING TO BE BOUND BY THE FOLLOWING TERMS AND CONDITIONS.

Glass Warehouse, LLC ("Seller") provides this Warranty to the business or individual ("Buyer") who purchases a Glass Warehouse product ("Product") directly from Seller or from an authorized reseller, including without limitation, shower kits, railing hardware, medicine cabinets, and mirrors. If Buyer is a licensed and fully insured professional and Buyer installs the Product in the residence of one of Buyer's customers ("Customer"), Buyer may pass this Warranty through to such Customer. In each case, this Warranty shall extend only to the original Buyer or Customer at the time of installation and shall expire if the original Buyer or Customer no longer owns or occupies the residence at which the Product is first installed. This Warranty will not apply to any subsequent owners or occupants of the residence. "Products" do not include, and this Warranty specifically excludes: (i) any products sold by Glass Warehouse under brand names other than Glass Warehouse; (ii) any third-party products distributed or sold by Glass Warehouse that are not incorporated into a Glass Warehouse Product.

Limited Lifetime Warranty for Glass

With respect to any glass components of the Product, Seller warrants to Buyer that for the lifetime of the Product ("Glass Warranty Period"), that such components (excluding seals) will materially conform to Seller's published specifications and will be free from material defects in material and workmanship. With respect to any Product used in commercial, industrial, or non-residential uses, including without limitation hotels, casinos, and apartments, the Glass Warranty Period is one (1) year. For mirrors, including medicine cabinets with mirrors, the Glass Warranty Period is one (1) year. For glass railings, the Glass Warranty Period is three (3) years. The Glass Warranty Period with respect to the outer coating of any glass component, such as an Enduroshield coating, is five (5) years.

Limited 5-Year Warranty for Hardware

With respect to any hardware components of the Product, Seller warrants to Buyer that for a period of five (5) years from the date of Buyer's purchase of the Product ("Hardware Warranty Period"), that such components (excluding seals) will materially conform to Seller's published specifications and will be free from material defects in material and workmanship. With respect to any

Product used in commercial, industrial, or non-residential uses, including without limitation hotels, casinos, and apartments, the Hardware Warranty Period is one (1) year. For mirrors, including medicine cabinets with mirrors, the Hardware Warranty Period is one (1) year. For railings, the Hardware Warranty Period is one (1) year. The Glass Warranty Period and Hardware Warranty Period are referred to together as the "Warranty Period."

While stainless steel is resistant to corrosion, it is not corrosion or rust-proof. Environmental conditions including, but not limited to, exposure to chemicals, salt air, pollution, and high humidity may cause surface discoloration or rust. Regular cleaning and maintenance is required to maintain the appearance and integrity of stainless steel products. Seller makes no warranty against and shall not be liable for any claims related to surface rust, discoloration, or corrosion of stainless steel components.

Warranty Terms and Conditions

This Warranty shall be voided if the Product (i) has been subjected to abuse, misuse, neglect, negligence, accident, improper testing, improper installation, improper cleaning (such as use of abrasive cleaners), improper storage, improper handling, abnormal physical stress, abnormal environmental conditions, or use or installation contrary to any instructions or guidelines issued by Seller; (ii) has been altered, repaired, or reconstructed by anyone other than Seller; (iii) was installed by anyone other than a fully insured and licensed professional; (iv) was not installed according to Glass Warehouse's published installation instructions or guidelines; (v) is installed or used outside of the US or Canada; or (vi) has been used with any third-party hardware or product that has not been previously approved in writing by Seller. This Warranty shall not apply to normal wear and tear. With respect to Products advertised by Glass Warehouse for outdoor use, this Warranty specifically excludes damage caused by extreme weather events.

WARNING: INSTALLATION OF GLASS PRODUCTS (I.E., SHOWER AND TUB DOORS) BY AN UNLICENSED OR INEXPERIENCED INSTALLER MAY RESULT IN GLASS BREAKAGE, DAMAGE TO PROPERTY, SERIOUS INJURY OR DEATH.

Neither Buyer, nor any other person is permitted to make any affirmation, representation, or warranty other than those contained in this Warranty. Any affirmation, representation, or warranty other than those contained in this Warranty shall not be enforceable against Seller or any other person. Seller reserves the right to modify this Warranty at any time, it being understood that such modifications will not alter the terms and conditions applicable at the time of sale of the products in question.

Please register your information to activate your warranty.
<https://www.glasswarehouse.us/warranty/>

Claims Process and Remedies:

All Warranty claims are subject to review and confirmation by Seller, and Seller reserves the right to inspect the installation to confirm the validity of the Warranty claim. To submit a Warranty claim, Buyer must:

1. Contact Seller's customer service department within 30 days of discovering the defect. Contact information:
Phone: +1 (760) 536-3640
Email: inquiries@glasswarehouse.us
<https://www.glasswarehouse.us/warranty/>.
2. Provide the following required documentation: (a) proof of purchase; (b) detailed description of the defect, including photographs; (c) item part number.
3. A customer service representative will review the claim and may request additional information or schedule an inspection of the Product and/or installation. Buyer must cooperate fully with any requests for information or inspection.

Seller shall have no obligation to honor any Warranty claim that does not comply with the above claims process. If a Warranty claim is approved, Seller shall, in its sole discretion, either: (i) repair or replace such Product (or the defective part), in which case Seller shall cover shipping of the repair parts or replacement product; or (ii) refund the price paid by Buyer to Seller for such Product. Replacement parts and products will be covered by this Warranty for the remainder of the Warranty Period of the original Product. Seller may require that the Product be returned to Seller, at Seller's expense. Except for any repairs made by Seller or its representatives as set forth above, Seller shall not pay for labor related to the Warranty claim, such as removal of the defective Product or installation of a replacement product. Seller's warranty obligation shall be discharged upon tender of parts, replacement or repair of the Product. Buyer's refusal to accept the tender terminates all warranty obligations and **VOIDS THIS WARRANTY.**

THE REMEDIES SET FORTH ABOVE SHALL BE BUYER'S SOLE AND EXCLUSIVE REMEDY AND SELLER'S ENTIRE LIABILITY FOR ANY BREACH OF THIS WARRANTY.

Disclaimer and Limitation of Liability:

EXCEPT FOR THE PRECEDING WARRANTY, SELLER MAKES NO WARRANTY TO BUYER WHATSOEVER WITH RESPECT TO THE PRODUCTS AND HEREBY DISCLAIMS ALL OTHER WARRANTIES, INCLUDING ANY (I) WARRANTY

OF MERCHANTABILITY; (II) WARRANTY OF FITNESS FOR A PARTICULAR PURPOSE; OR (III) WARRANTY AGAINST INFRINGEMENT OF INTELLECTUAL PROPERTY RIGHTS OF A THIRD PARTY; WHETHER EXPRESS OR IMPLIED BY LAW, COURSE OF DEALING, COURSE OF PERFORMANCE, USAGE OF TRADE OR OTHERWISE.

SELLER DISCLAIMS AND SHALL NOT BE LIABLE FOR ANY PERSONAL INJURIES OR DEATH TO ANY PERSON, INCIDENTAL DAMAGES, CONSEQUENTIAL DAMAGES, LOSS OF PROFITS, LOSS OF USE, LABOR OR MATERIAL CHARGES, OR ANY OTHER COSTS RELATING TO THE USE OR INABILITY TO USE THE PRODUCT OR REPLACEMENT PRODUCT OR RELATING TO THE APPLICATION OF THIS WARRANTY. IN NO EVENT SHALL SELLER'S AGGREGATE LIABILITY EXCEED THE PURCHASE PRICE OF THE PRODUCT.

SOME STATES LIMIT A MANUFACTURER'S ABILITY TO DISCLAIM CERTAIN WARRANTIES OR LIABILITIES AND THEREFORE SOME OF THE ABOVE DISCLAIMERS OR LIMITATIONS OF LIABILITY MAY NOT APPLY TO YOU.

Warranty Service

To activate your limited lifetime warranty, please visit:
<https://www.glasswarehouse.us/warranty/>



Please register your information within 30 days of purchase to complete the activation of your warranty.

Contact Technical Support:

**Monday – Friday 8am – 5pm PST
Technical Support: +1 (760) 536-3640**

GLASSWAREHOUSE

Register Your Warranty Today!

To activate your limited lifetime warranty, please visit:
<https://www.glasswarehouse.us/warranty/>



We will require this information within 30 days of purchase to complete the activation of your warranty.