

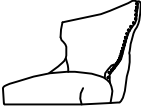





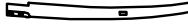
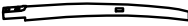
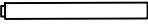
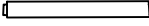
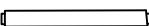
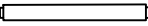

ASSEMBLY INSTRUCTION

COUNTER / BAR HEIGHT STOOL

A Chair  1PC	B Front Left Leg  1PC	C Front Right Leg  1PC	D Left Rear Leg  1PC
E Right Rear Leg  1PC	F Front Stretcher  1PC	G Left Stretcher  1PC	H Right Stretcher  1PC
I Rear Stretcher  1PC	J Bolt 5/16"×2-1/2"  4PCS	K Bolt 5/16"×2"  4PCS	L Lock Washer 5/16"  8PCS
M Flat Washer 5/16"×22MM  8PCS	N Allen Wrench 5MM  1PC	O Self-Tapping Screw #8×1-3/4"  8PCS	

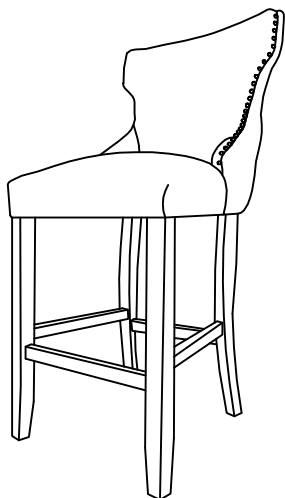

This page lists all the contents included in the box. Please take the time to identify the hardware as well as the individual components to this product. As you unpack and prepare for assembly, place the contents on a carpeted or padded area to protect them from damage.

1 Attached Chair(A), Front Left Leg(B), Front Right Leg(C), Front Stretcher(F), Flat Washer(M), Lock Washer(L), Bolt(J) by Allen Wrench(N).

Take the Allen Wrench, and turn the bolts until the legs are secure.

DO NOT TIGHTEN COMPLETELY.

Stop when you feel you are adding force to tighten the bolt.

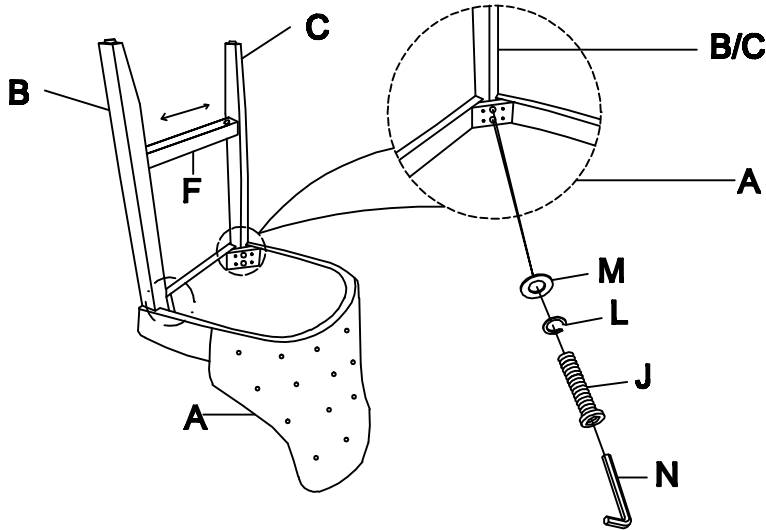

2 Attached Chair(A), Left Rear Leg(D), Right Rear Leg(E), Rear Stretcher(I), Left Stretcher(G), Right Stretcher(H), Flat Washer(M), Lock Washer(L), Bolt(K) by Allen Wrench(N).

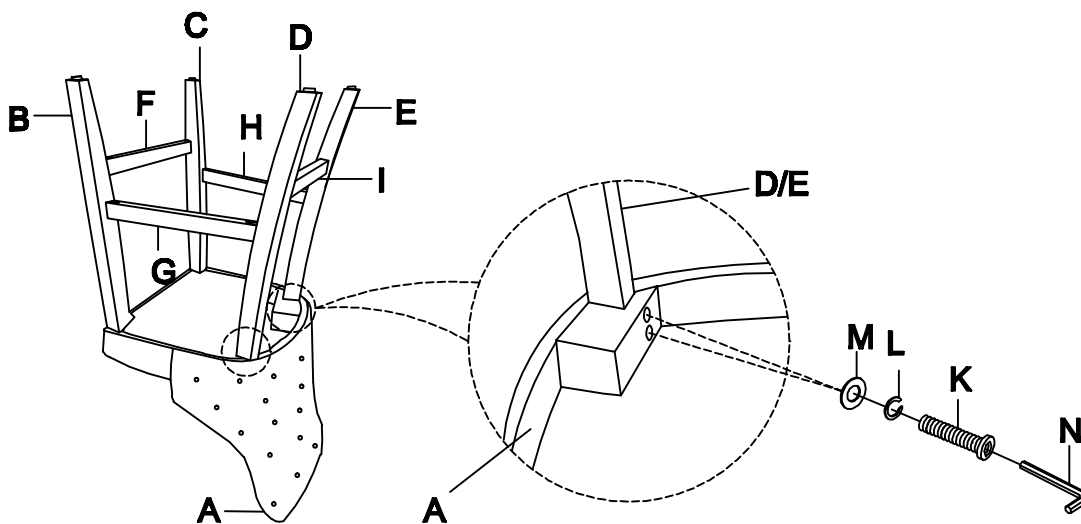

3 Attached Self-Tapping Screw(O) to Front Stretcher(F), Left Stretcher(G), Right Stretcher(H), Rear Stretcher(I).

Stand chair up on an even surface and check that it is balanced. If there is a slight wobble, apply downward pressure in the corner where a leg is uneven. Keeping pressure in that corner, tighten all bolts. If balanced, apply downward pressure evenly in the center and tighten all bolts. Do not over-tighten beyond hole depth.

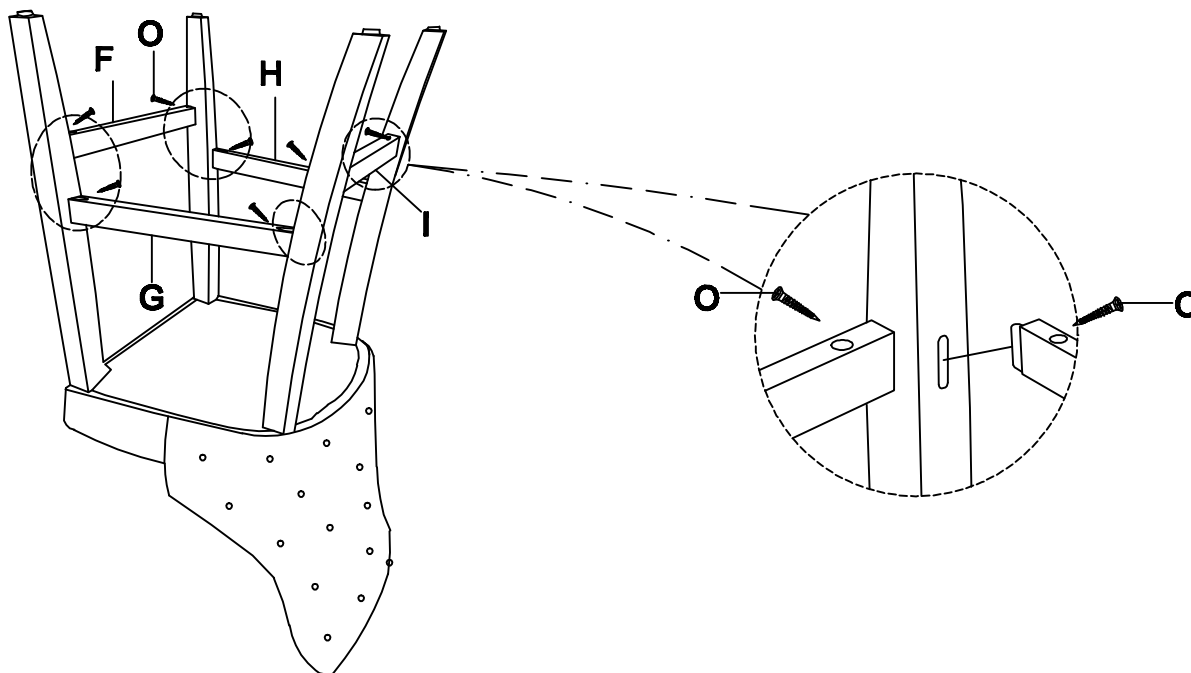

Helpful Tip:

-Instead of applying downward pressure while reaching under to tighten bolts, have someone sit in the chair while you tighten the bolts.

Cleaning & Care

Treat surface with care. Surface is resistant to scratches but is not scratch resistant. Clean surfaces with a dry or damp soft cloth. Do not use abrasive cleaners. Hardware may loosen over time. Periodically check that all connections are tight.