



**INSTRUCTIONS D'ASSEMBLAGE  
ASSEMBLY INSTRUCTIONS**

---

**TABLE D'APPOINT -  
METAL CHROME / GRIS CIMENTE AVEC TIROIR**

**ACCENT TABLE -  
CHROME METAL / GREY CEMENT WITH A DRAWER**

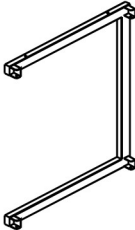
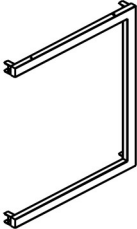
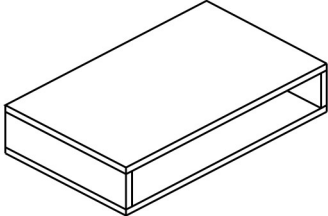
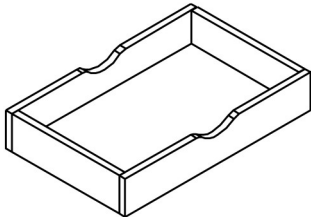
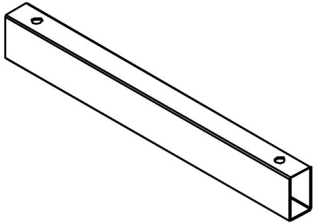

**LISTE DES PIÈCES**  
**PARTS LIST**

PIÈCE / PART #	IMAGE	DESCRIPTION	QTY / QTÉ
1		<b>FRONT FACING LEFT LEG</b> <b>PATTE AVANT GAUCHE</b>	1
2		<b>FRONT FACING RIGHT LEG</b> <b>PATTE AVANT DROITE</b>	1
3		<b>TABLE TOP</b> <b>SURFACE DE TABLE</b>	1
4		<b>DRAWER</b> <b>TIROIR</b>	1
5		<b>STRECTHER</b> <b>CHÂSSIS</b>	4

## LISTE DES PIÈCES DE MONTAGE

### HARDWARE LIST

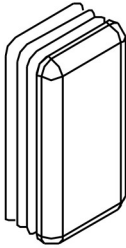
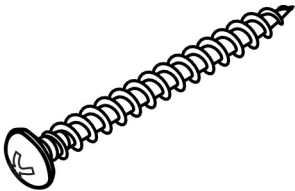
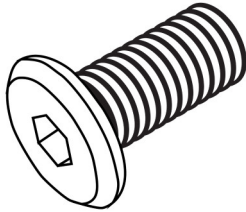
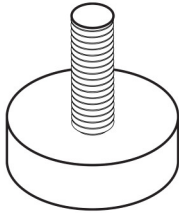
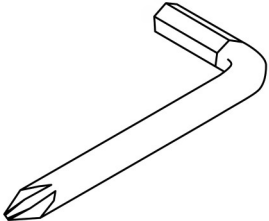
PIÈCE / PART #	IMAGE	DESCRIPTION	QTY / QTÉ
<b>A</b>		CAP - 1/2" X 1"  CAPUCHON - 1/2" X 1"	4
<b>B</b>		ASSEMBLING SCREW - Ø1/8" X 1 3/8"  VIS D'ASSEMBLAGE - Ø1/8" X 1 3/8"	4
<b>C</b>		ASSEMBLING BOLT - Ø1/4" X 1/2"  BOULON D'ASSEMBLAGE - Ø1/4" X 1/2"	8
<b>D</b>		ADJUSTABLE LEG - Ø1/4" X 3/8"  PATTE AJUSTABLE - Ø1/4" X 3/8"	4
<b>E</b>		HEX KEY  CLÉ HEXAGONALE	1

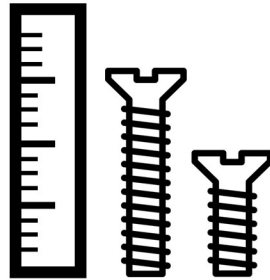

**OUTIL DE VÉRIFICATION DE DIMENSIONS DES PIÈCES  
HARDWARE DIMENSIONS VERIFICATION TOOL**

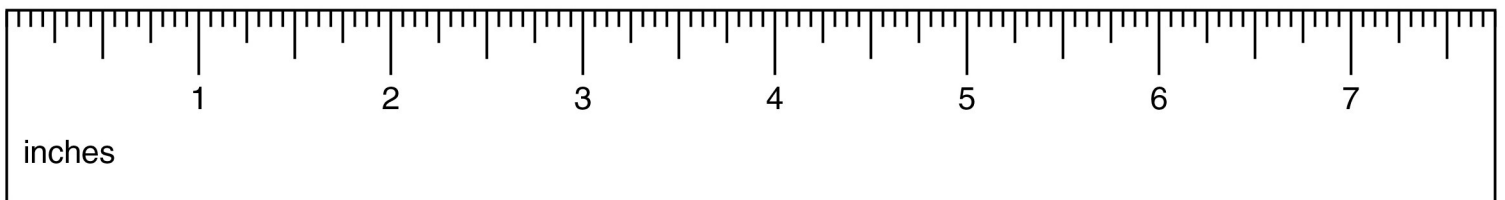

**ÉTAPE / STEP 1**

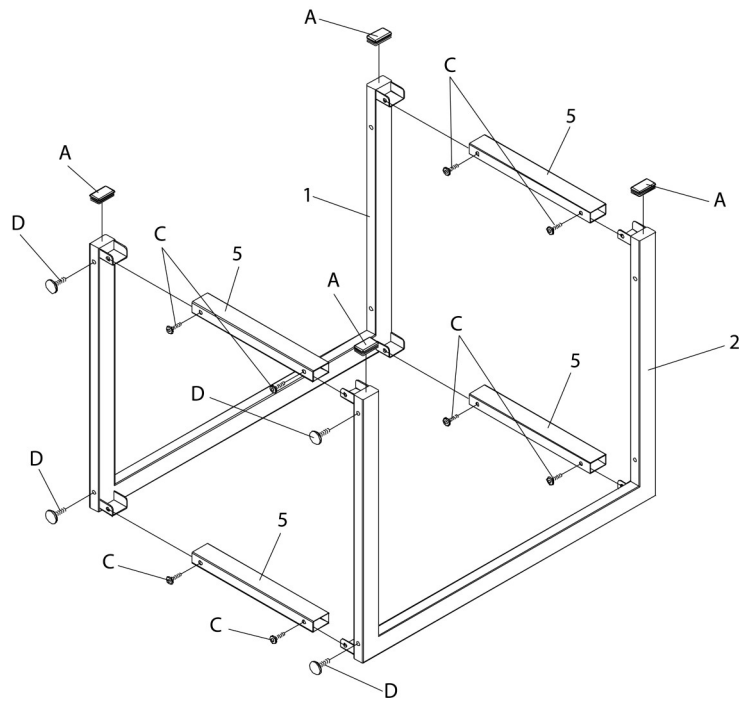

**ÉTAPE / STEP 2**

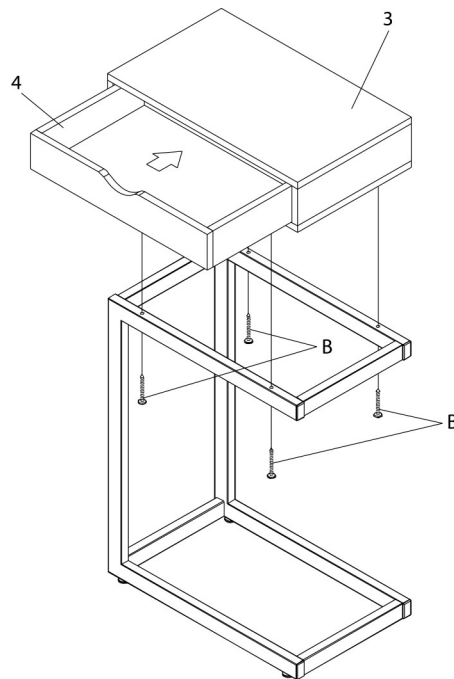

ÉTAPE / STEP 3

