

Assembly Instructions

CAUTION: You must read this **Assembly Instructions** before you proceed.

Please look in the **Seat Panel** for hardware packs.

Chair

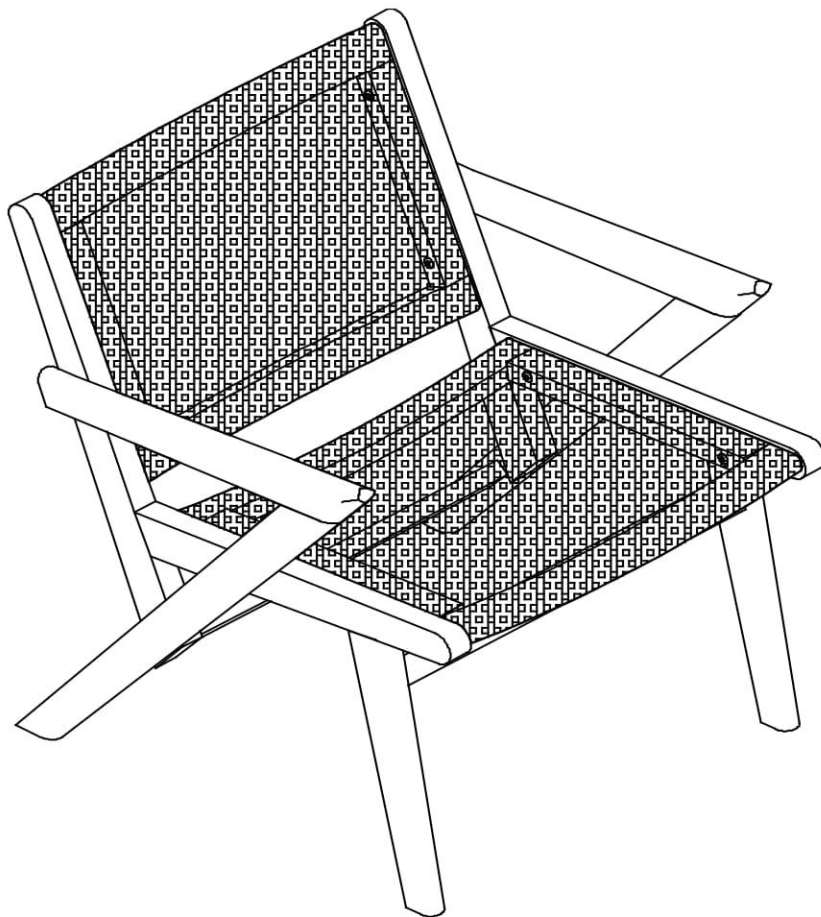





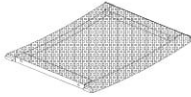

CAUTION: This Chair is NOT a TOY.

Keep your child / children at bay during the assembly process.

Whenever lifting or moving the Chair and to prevent any damage to it, two adults may be needed to execute these actions.

Part List

Label	Picture	Description	QTY
A		Seat Panel	1
B		Backrest Panel	1
C		Right Leg Panel	1
D		Left Leg Panel	1
E		First Support Bar	1
F		Second Support Bar	1

Hardware

Label	Picture	Description	QTY
①		Bolt (M6x60mm)	9
②		Screw (M6x50mm)	5
③		Allen Wrench	1

Assembly Preparation

Before Beginning Assembly:

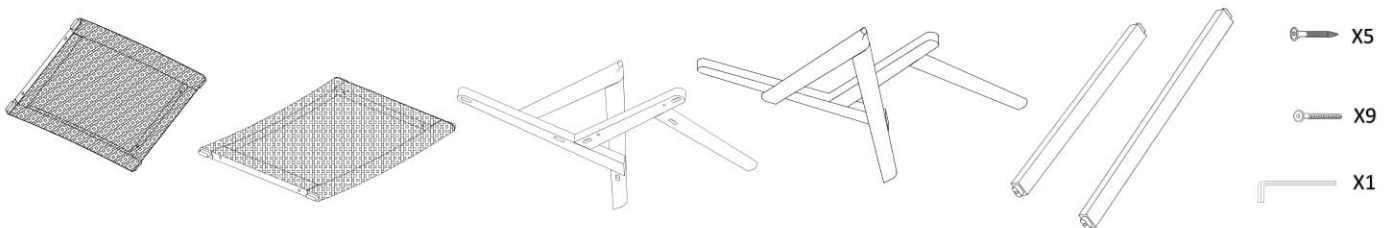

- Read instructions, cover to cover-



- Have 2 adults on hand for assembly-



- Do not assemble on flooring or carpet-



- Assemble on a clean non-marring surface (packing foam)-



- Save all packaging until finished-

Assembly Steps

Overview

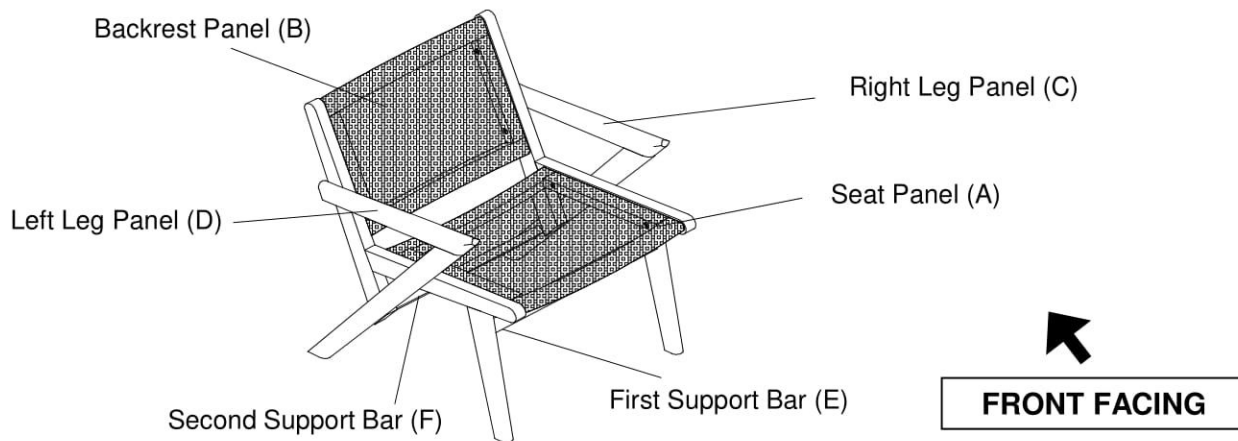

This Chair has multiple parts and may require up to 40 minutes to assemble. To give you an overview of the Chair parts, the above picture is provided to help you put the various parts into perspective. Please read through the instructions below to familiarise yourself with the parts and steps before assembly.

Step 1



Unpack and place all parts on a clean, non-marring surface.

Step 2

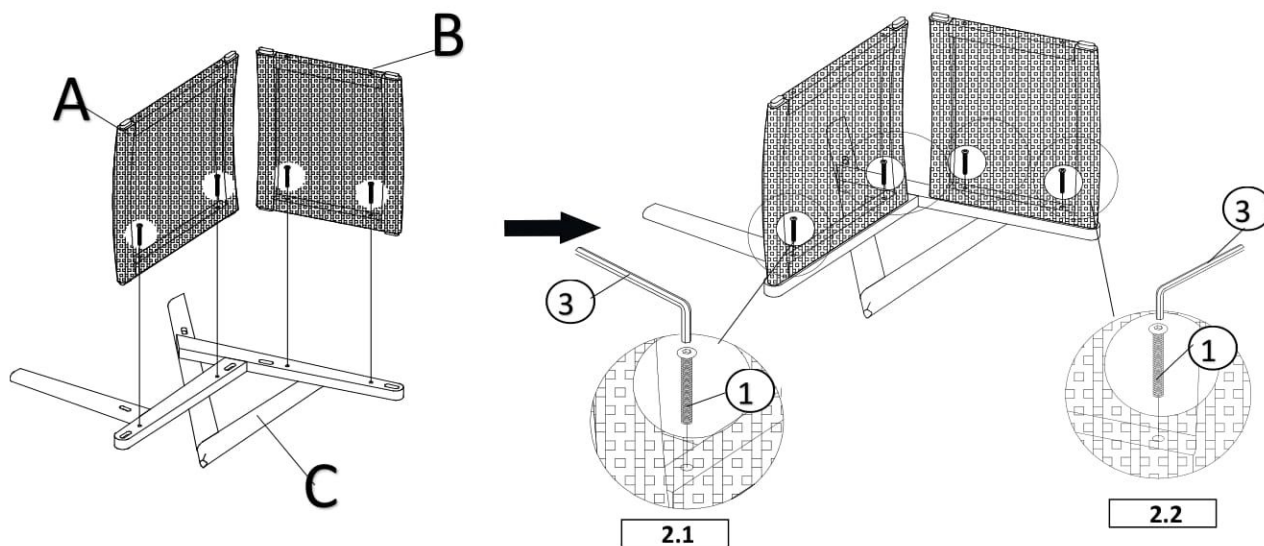

Place the Right Leg Panel (C) as shown in the picture above, onto a clean, soft surface to avoid any scratches or damage to the product.

Step 2.1: With assistance from your adult partner(s), attach the Seat Panel (A) to the Right Leg Panel (C) using Bolts (1) and the Allen Wrench (3) as the pictures show above.

Step 2.2: Then attach the Backrest Panel (B) to the Right Leg Panel (C) using Bolts (1) and the Allen Wrench (3) as the pictures show above.

Do not fully tighten the Bolts at this time.

Step 3

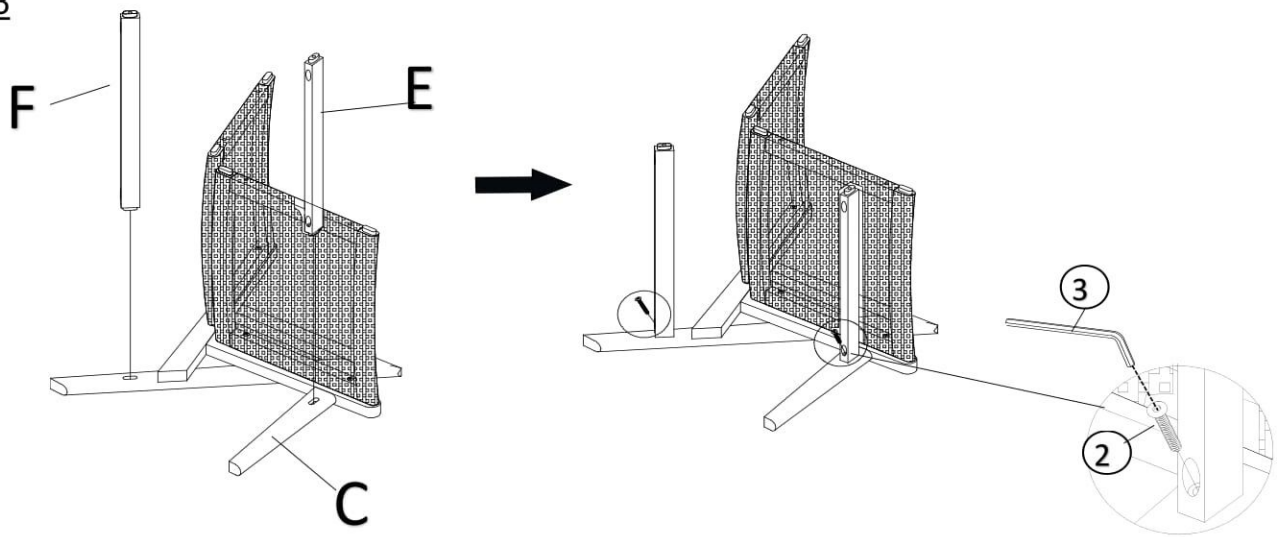

With assistance from your adult partner(s), rotate the chair from front to back, attach the First Support Bar (E), then the Second Support Bar (F) to the Right Leg Panel (C) using the Screws (2) and the Allen Wrench (3) as the pictures show above.

Do not fully tighten the Screws at this time.

Step 4

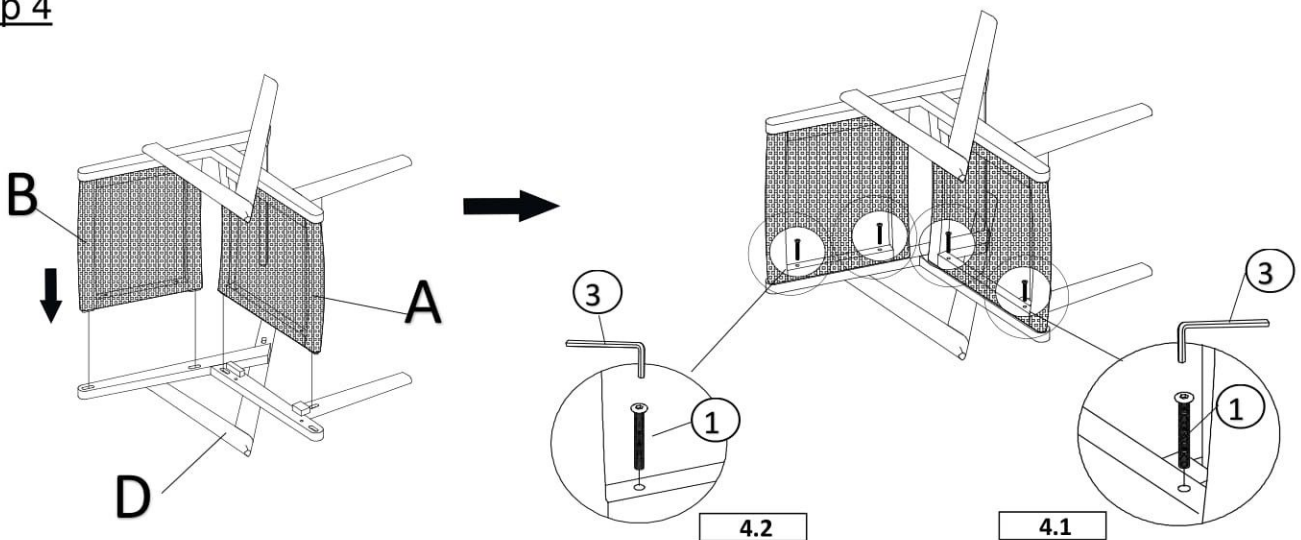

Place the Left Leg Panel (D) as shown in the picture above onto a clean, soft surface to avoid any scratches or damage to the product.

Step 4.1: With assistance from your adult partner(s), attach the Seat Panel (A) to the Left Leg Panel (D) using Bolts (1) and the Allen Wrench (3) as the pictures show above.

Step 4.2: Then attach the Backrest Panel (B) to the Left Leg Panel (D) using Bolts (1) and the Allen Wrench (3) as the pictures show above.

Do not fully tighten the Bolts at this time.

Step 5

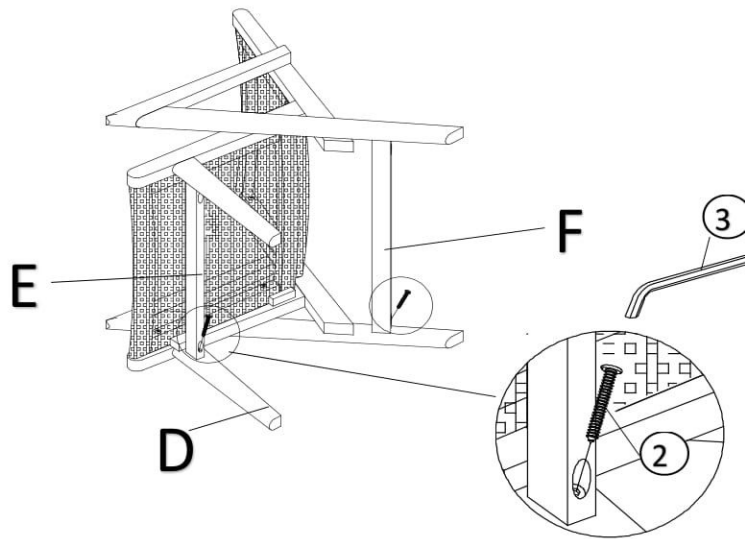

With assistance from your adult partner(s), rotate the chair from back to front, attach the First Support Bar (E), then the Second Support Bar (F) to the Left Leg Panel (D) using the Screws (2) and the Allen Wrench (3) as the pictures show above.

Do not fully tighten the Screws at this time.

Step 6

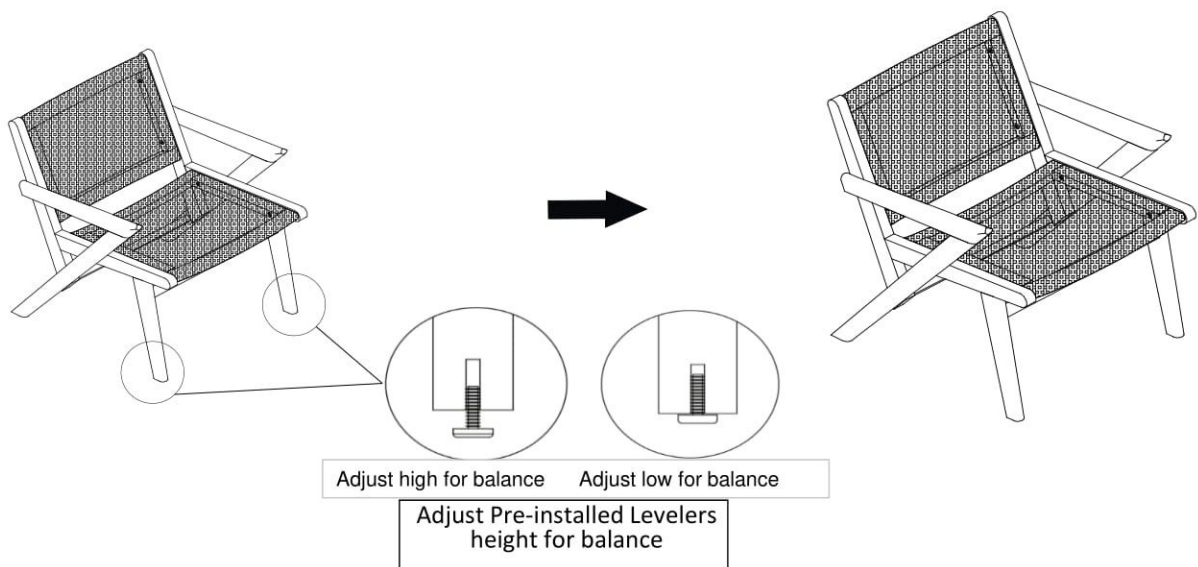

Turn the Chair right side up.

With assistance from your adult partner, adjust the Levelers to the desired height to avoid wobbles.

Inspect the Chair and make sure all parts are adequately connected.

In a sequential manner, tighten all Screws and Bolts at all joints.

CAUTION : When tightening these screws and bolts, tighten sequentially.





















DO NOT tighten any screw or bolt fully and then move towards the next one. This could cause the frame to warp.

WARNING!! IF THE CHAIR IS NOT STABLE , IT COULD LEAD TO DAMAGE OF THE PRODUCT.

Your Chair is ready to be used.

This Chair can only be used on a flat, level surface.

Care & Maintenance

-   ● Do not put hot items directly on furniture surface
 -   ● Do not clean furniture with harsh cleansers or polish.
 -   ● To obtain the longest lifespan of your outdoor products, minimizing exposure to direct sunlight is recommended.
 -   ● Children should not climb or jump on the furniture.
 -   ● Do not write on furniture without a padded barrier to protect the surface.
 -   ● To obtain the longest lifespan of your outdoor products, avoid extended and lengthy exposure to rain, snow, and direct sunshine. Whenever possible cover the product and /or place under patio or awnings.
 -   ● Not for commercial use. For residential use only .
 -   ● Stains may be removed with mild soap solution and damp cloth.
 -   ● Keep away from sources of ignition.
-
-   ● Dust and pick-up spills using a clean, non-colored, lint-free cloth.