





| | | | | |
|---|---|---|--|---|
| A | B | C | D | E |
|  |  |  |  |  |
| x 1 | x 1 | x 5 | x 5 | x 5 |



A

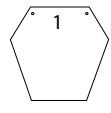
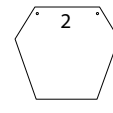
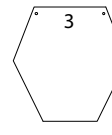
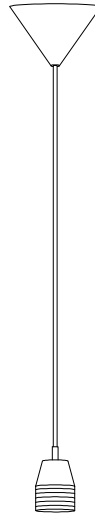

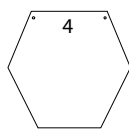
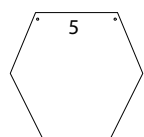
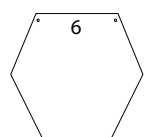
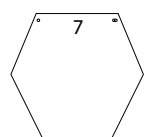
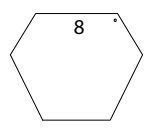
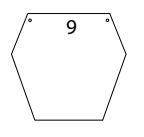
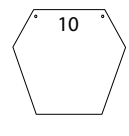
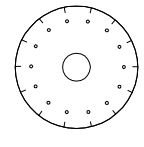
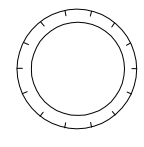
B

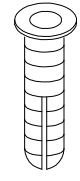
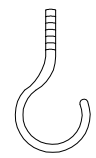
| | | | | | |
|---|---|---|---|---|---|
| F | G | H | I | J | K |
|  |  |  |  |  |  |
| x 5 | x 5 | x 5 | x 5 | x 5 | x 5 |
| L | M | N | O | P | Q |
|  |  |  |  |  |  |
| x 5 | x 1 | x 1 | x 10 | x 1 | x 1 |



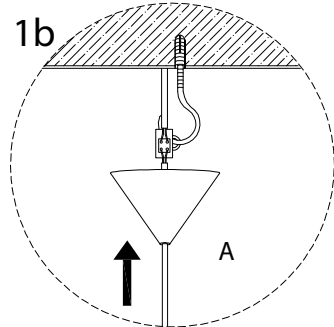
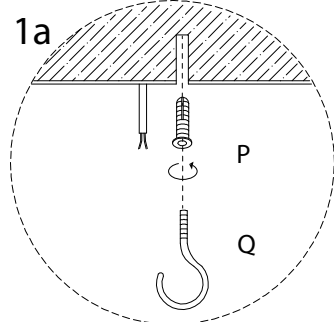
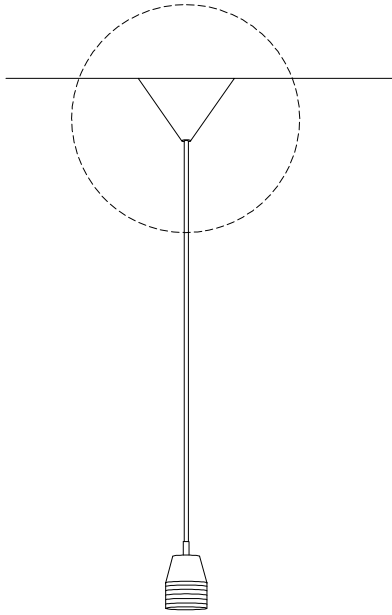
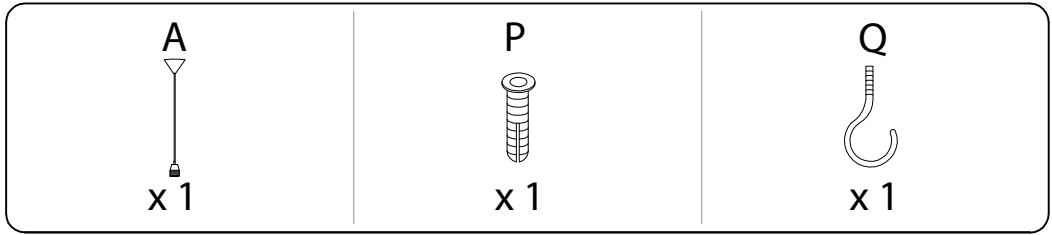



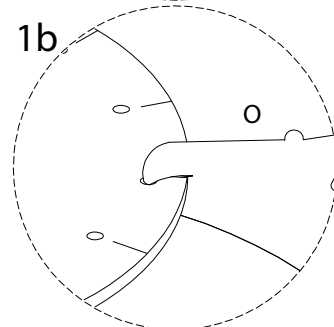
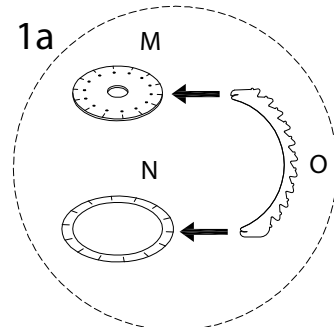
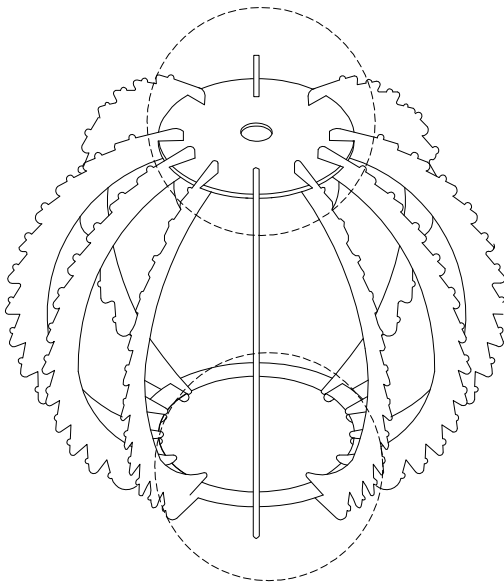
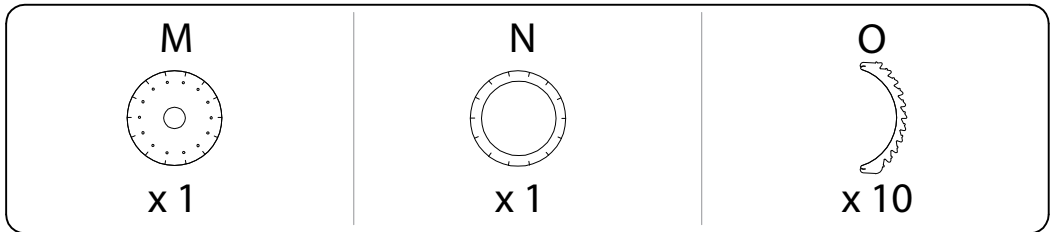



1



2



3

| | | | | |
|--|--|--|--|--|
| C  x5 | D  x5 | E  x5 | F  x5 | G  x5 |
| H  x5 | I  x5 | J  x5 | K  x5 | L  x5 |

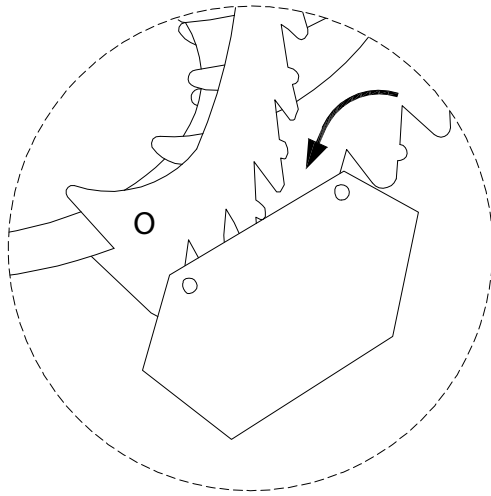
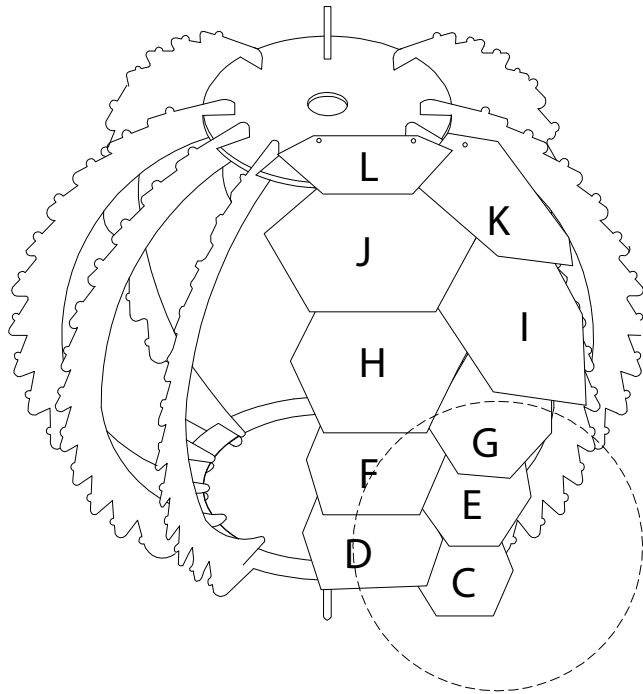

4

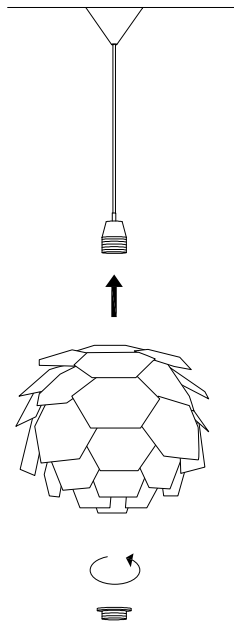
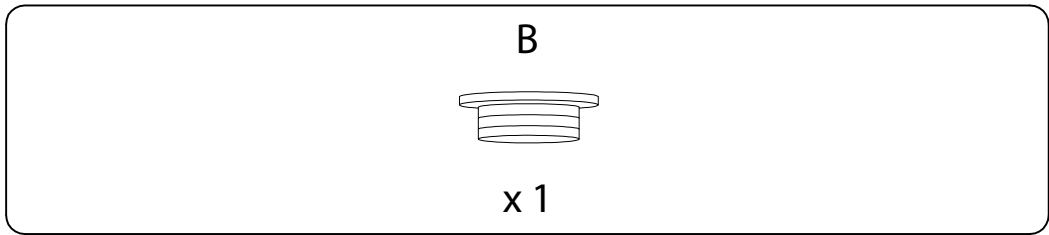

B

5

