

INSTALLATION MANUAL

VD008-WH-JHR-UK
VD008-BK-JHR-UK

OUR PACKAGE

The item comes in two boxes
and may not arrive at the same time



[*support@Yanosaku.com*](mailto:support@Yanosaku.com)

NOTICE

IMPORTANT, RETAIN FOR FUTURE REFERENCE: READ CAREFULLY
WICHTIG, FÜR SPÄTERE NACHSCHLAGE AUFBEWAHREN: SORGFÄLTIG LESEN
IMPORTANTE, GUARDAR PARA REFERENCIA FUTURA: LEER ATENTAMENTE
IMPORTANTE, CONSERVARE PER RIFERIMENTI FUTURI: LEGGERE ATTENTAMENTE
IMPORTANT, À CONSERVER POUR RÉFÉRENCE FUTURE : LIRE ATTENTIVEMENT

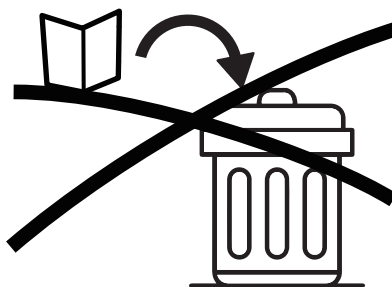
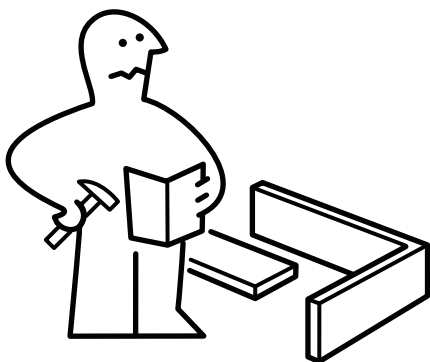

Assemble on a flat, clean and soft surface.

Auf einer flachen, sauberen und weichen Oberfläche zusammenbauen.

Assembler sur une surface plate, propre et douce.

Assemblare su una superficie piatta, pulita e morbida.

Ensamblar sobre una superficie plana, limpia y suave.

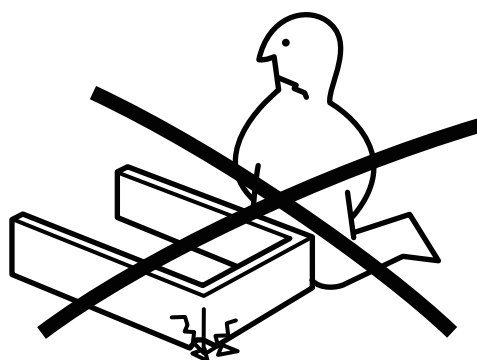
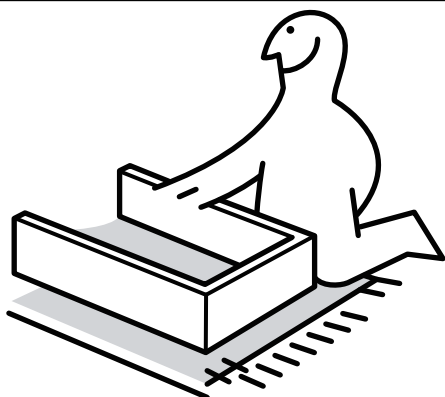

Professional installation is highly recommended.

Eine professionelle Installation wird dringend empfohlen.

Une installation professionnelle est fortement recommandée.

Si raccomanda vivamente l'installazione professionale.

Se recomienda altamente la instalación profesional.



Periodically check that all components are tightly secured.

Überprüfen Sie Regelmäßig, Dass Alle Komponenten Fest Gesichert Sind.

Vérifiez Périodiquement Que Tous Les Composants Sont Bien Fixés.

Controllare Periodicamente Che Tutti I Componenti Siano Ben Fissati.

Verifique Periódicamente Que Todos Los Componentes Estén Bien Asegurados.



It is recommended that multiple people assemble this product.

Es wird empfohlen, dass mehrere Personen dieses Produkt zusammenbauen.

Il est recommandé que plusieurs personnes assemblent ce produit.

Si raccomanda che più persone assemblino questo prodotto.

Se recomienda que varias personas ensamblen este producto.

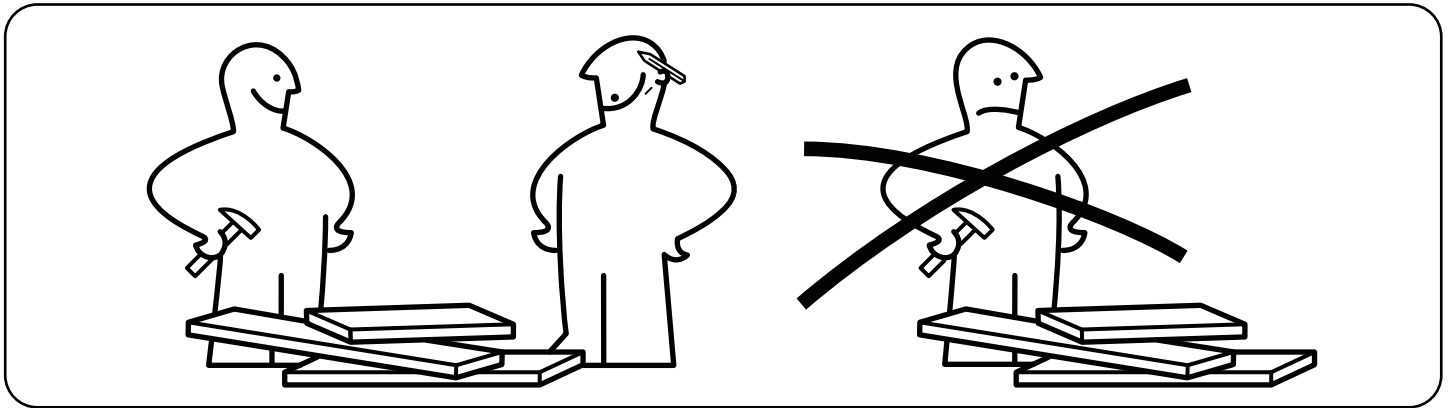

Press And Hold The Drawer Runner Lock And Then Continue To Slide Drawer Runners Apart Before Installation.

Drücken Und Halten Sie Die Schubladenauszugssperre Und Schieben Sie Dann Die Schubladenauszüge Auseinander, Bevor Sie Installieren.

Pressez Et Maintenez Le Verrou Du Coulisseau Du Tiroir, Puis Continuez À Écarter Les Coulisses Du Tiroir Avant L'installation.

Premere E Tenere Premuto Il Blocco Della Guida Del Cassetto, Quindi Continuare A Scorrere Le Guide Del Cassetto Separatamente Prima Dell'installazione.

Presione Y Mantenga Presionado El Bloqueo Del Corredor Del Cajón Y Luego Continúe Deslizando Los Corredores Del Cajón Por Separado Antes De La Instalación.

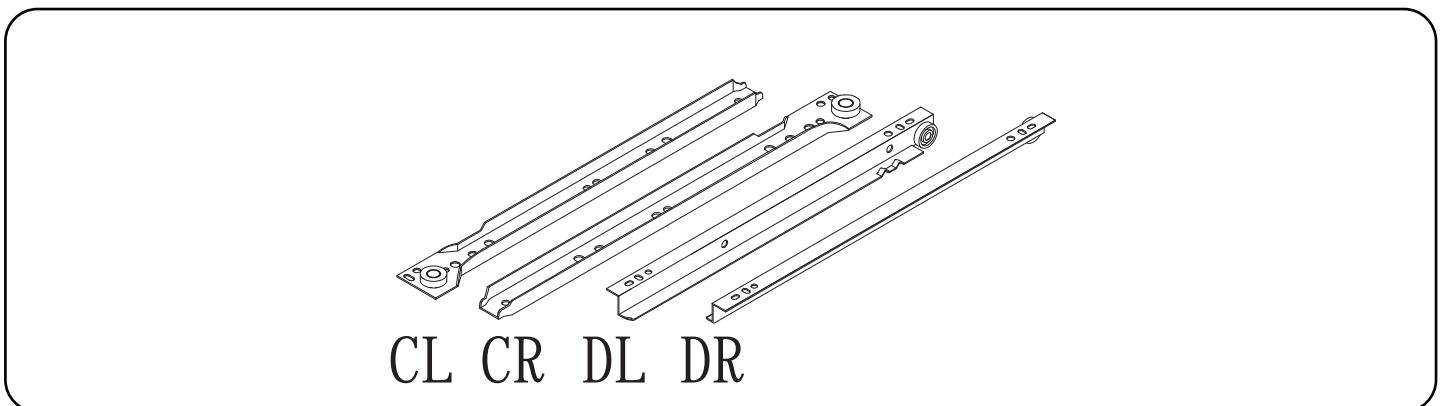

Please have the following auxiliary tools ready:

Bitte halten Sie folgende Hilfswerkzeuge bereit:

Veillez préparer les outils auxiliaires suivants :

Si prega di avere pronti i seguenti strumenti ausiliari:

Por favor, tenga listas las siguientes herramientas auxiliares:

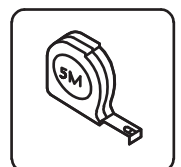
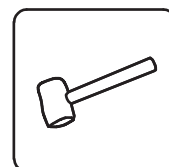

Never let children climb or hang on drawers, doors, or shelves.

Lassen Sie Kinder niemals auf Schubladen, Türen oder Regalen klettern oder hängen.

Ne laissez jamais les enfants grimper ou se suspendre aux tiroirs, portes ou étagères.

Non permettere mai ai bambini di arrampicarsi o appendersi ai cassetti, alle porte o agli scaffali.

Nunca permita que los niños trepen o se cuelguen de los cajones, puertas o estantes.



Serious or fatal crushing injuries can occur from furniture tip-over. Always secure this furniture to the wall using tip-over restraints.

Schwere oder tödliche Quetschverletzungen können durch das Umkippen von Möbeln verursacht werden. Sichern Sie diese Möbel immer mit Kipp-Sicherungen an der Wand.

Des blessures graves ou mortelles par écrasement peuvent survenir en cas de basculement de meubles. Fixez toujours ces meubles au mur à l'aide de dispositifs anti-basculement.

Lesioni gravi o mortali da schiacciamento possono verificarsi a causa del ribaltamento dei mobili. Fissare sempre questi mobili alla parete utilizzando i sistemi di blocco anti-ribaltamento.

Pueden ocurrir lesiones graves o fatales por aplastamiento debido al volcamiento de muebles. Siempre asegure este mueble a la pared utilizando dispositivos anti-vuelco.

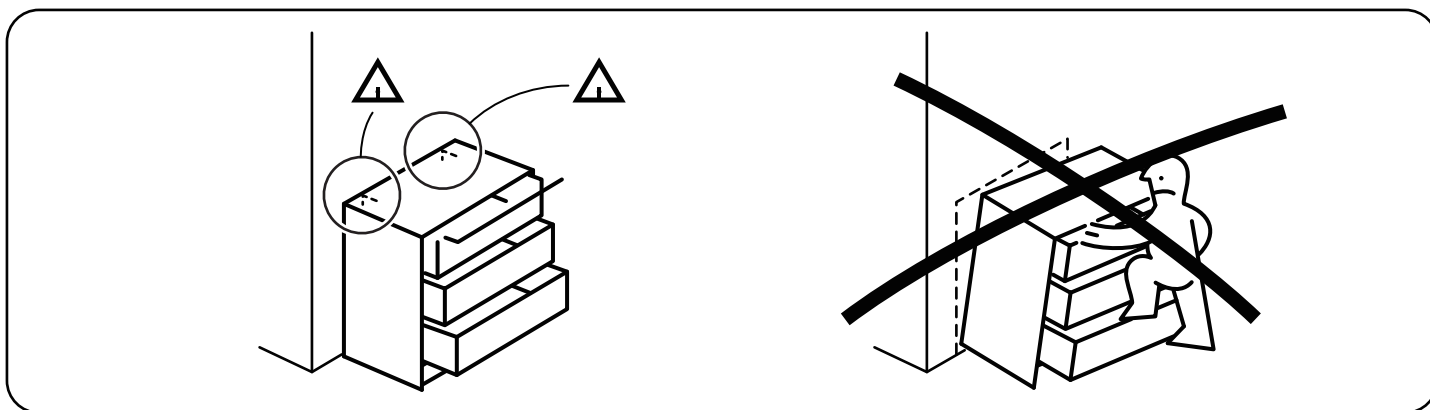

To prevent panel damage during assembly, avoid using power tools and opt for manual tools instead.

Um Schäden an den Paneelen während der Montage zu vermeiden, vermeiden Sie Elektrowerkzeuge und verwenden Sie stattdessen Handwerkzeuge.





Pour éviter d'endommager les panneaux lors de l'assemblage, évitez les outils électriques et utilisez plutôt des outils manuels.

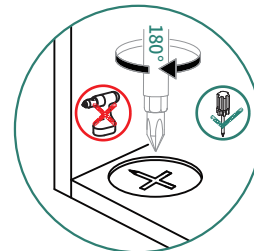
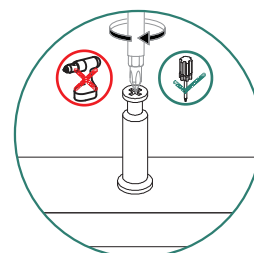



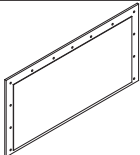
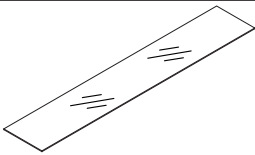
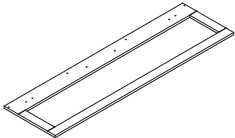
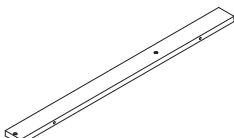
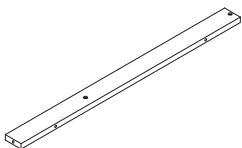

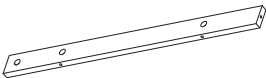
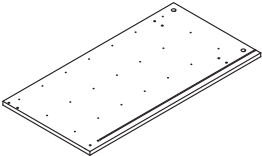
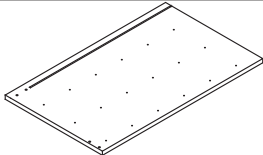
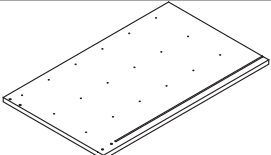
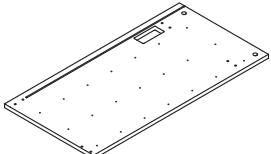
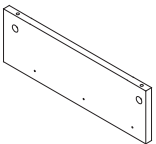
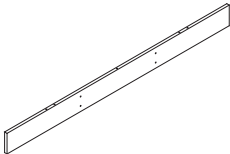
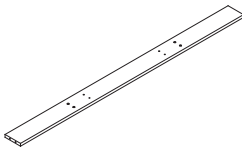
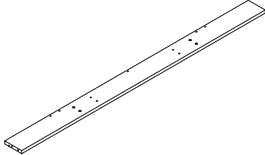
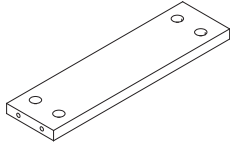
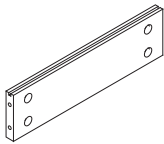
Per prevenire danni ai pannelli durante il montaggio, evita gli utensili elettrici e usa invece utensili manuali.

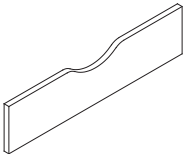

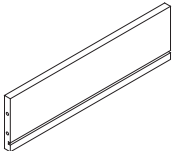
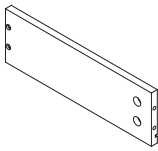
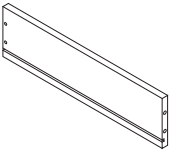
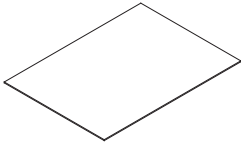
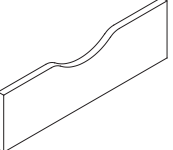
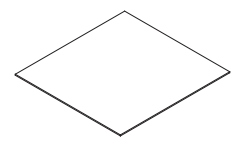
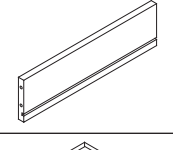
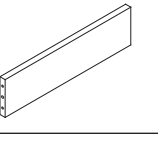
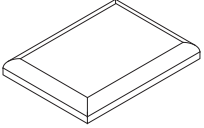
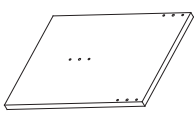
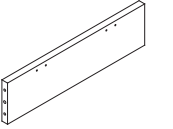
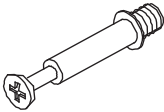

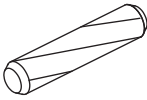

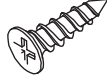
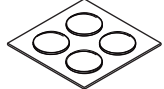
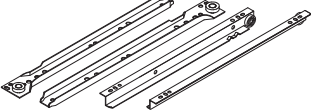

Para prevenir daños en los paneles durante el montaje, evite herramientas eléctricas y use herramientas manuales en su lugar.

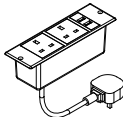
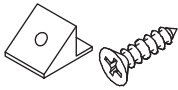
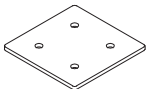

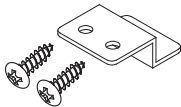
PARTS

Item no. Nr. N° d'article Articolo No. Artículo No.	Reference Image Referenzbild Image de référence Immagine di riferimento Imagen de referencia	Qty. Menge Qté. Qtà Cant.	Item no. Nr. N° d'article Articolo No. Artículo No.	Reference Image Referenzbild Image de référence Immagine di riferimento Imagen de referencia	Qty. Menge Qté. Qtà Cant.
1		X1	2		X1
3		X1	4		X1
5		X1	6		X2
7		X2	8		X1
9		X1	10		X1
11		X1	12		X2
13		X1	14		X1
15		X1	16		X2
17		X2	18		X1
19		X1	20		X3

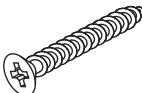
Item no. Nr. N° d'article Articolo No. Artículo No.	Reference Image Referenzbild Image de référence Immagine di riferimento Imagen de referencia	Qty. Menge Qté. Qtà Cant.	Item no. Nr. N° d'article Articolo No. Artículo No.	Reference Image Referenzbild Image de référence Immagine di riferimento Imagen de referencia	Qty. Menge Qté. Qtà Cant.
21		X3	22		X15
23		X15	24		X3
25		X12	26		X12
27		X12	28		X1
29		X1	30		X2
31		X2			
A		X111+6	B		X111+6
C		X27+2	D	 4*40MM	X23+2
E	 3.5*12MM	X154+8	F		X8
G	 CL CR DL DR	X15	H		X1

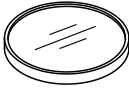
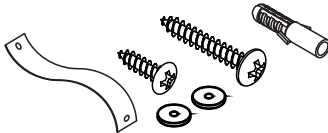
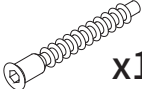
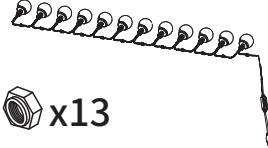
Item no. Nr. N° d'article Articolo No. Artículo No.	Reference Image Referenzbild Image de référence Immagine di riferimento Imagen de referencia	Qty. Menge Qté. Qtà Cant.	Item no. Nr. N° d'article Articolo No. Artículo No.	Reference Image Referenzbild Image de référence Immagine di riferimento Imagen de referencia	Qty. Menge Qté. Qtà Cant.
I		X1	J		X8
K		X1	L		X12
M		X8	N		X4
O		X16	P	 4*14MM	X16
Q	 4*35MM	X60+4	R	 3.5*14MM	X4
S		X1	T		X1
U	 x12		LED	 x13	

ASSEMBLY

1

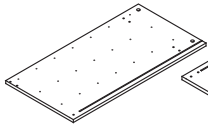

⑧ 1pc

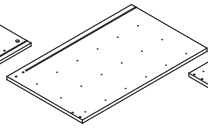

⑨ 1pc

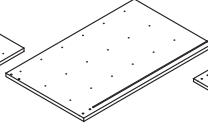

⑩ 1pc

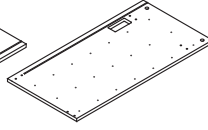

⑪ 1pc

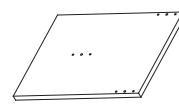

③⑩ 2pcs



Ⓛ 12pcs

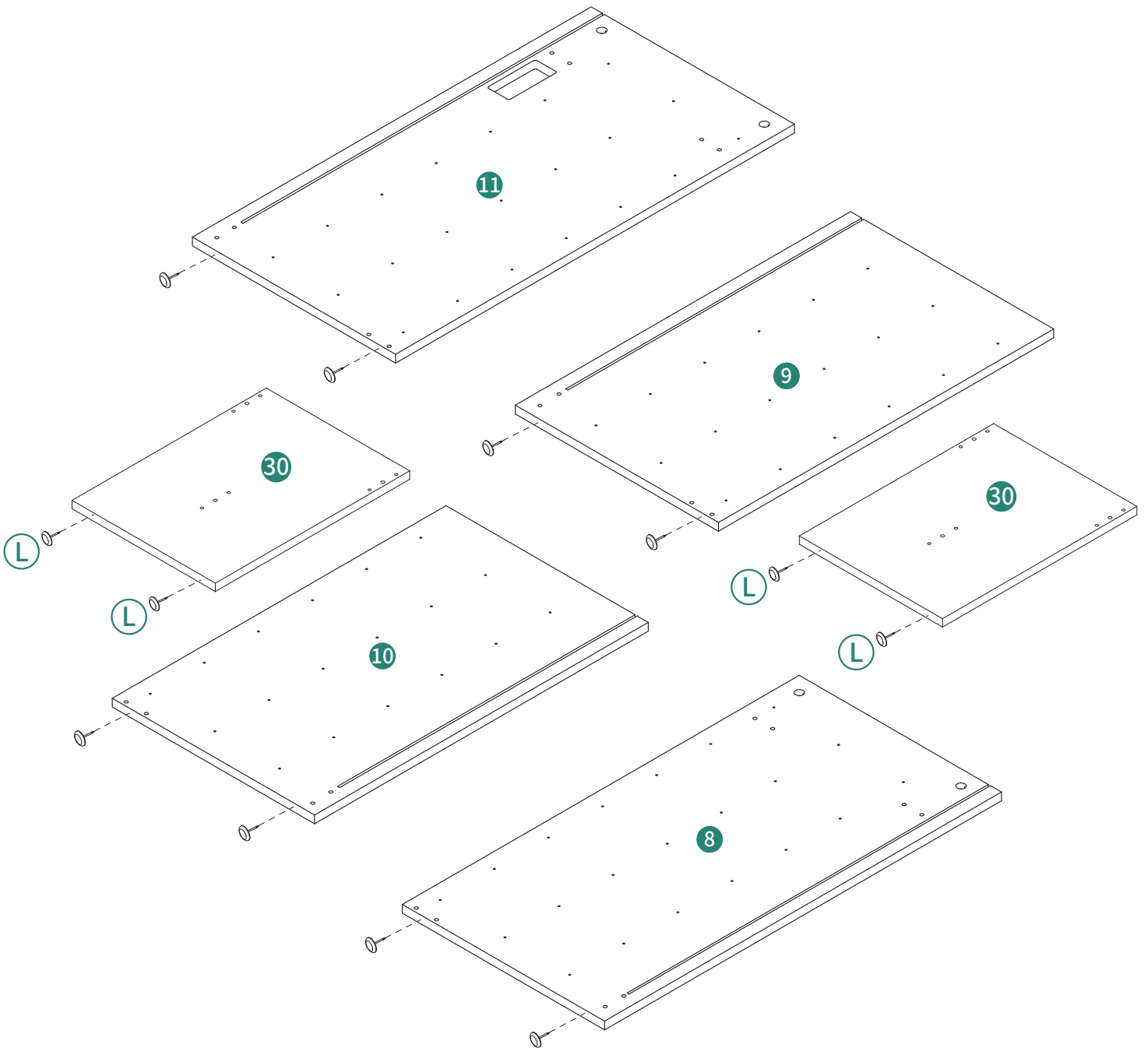

2

ST3.5X12mm

⑧1pc ①A6pcs ②E21pcs ③G7pcs

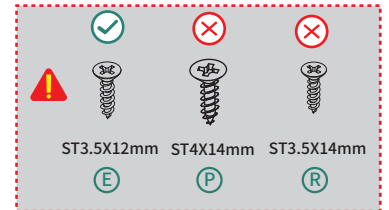
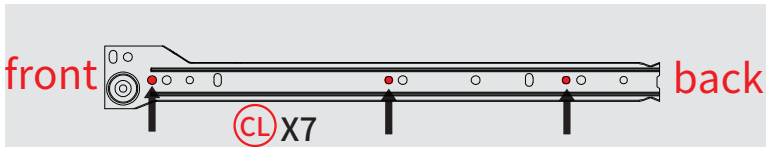
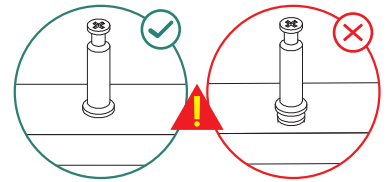

Align the screws with the center of the mounting hole of the guide rail.
 Richten Sie die Schrauben mit der Mitte des Montagelochs der Führungsschiene aus.
 Alignez les vis avec le centre du trou de montage du rail de guidage.
 Allineare le viti con il centro del foro di montaggio della guida.
 Alinee los tornillos con el centro del orificio de montaje de la guía.

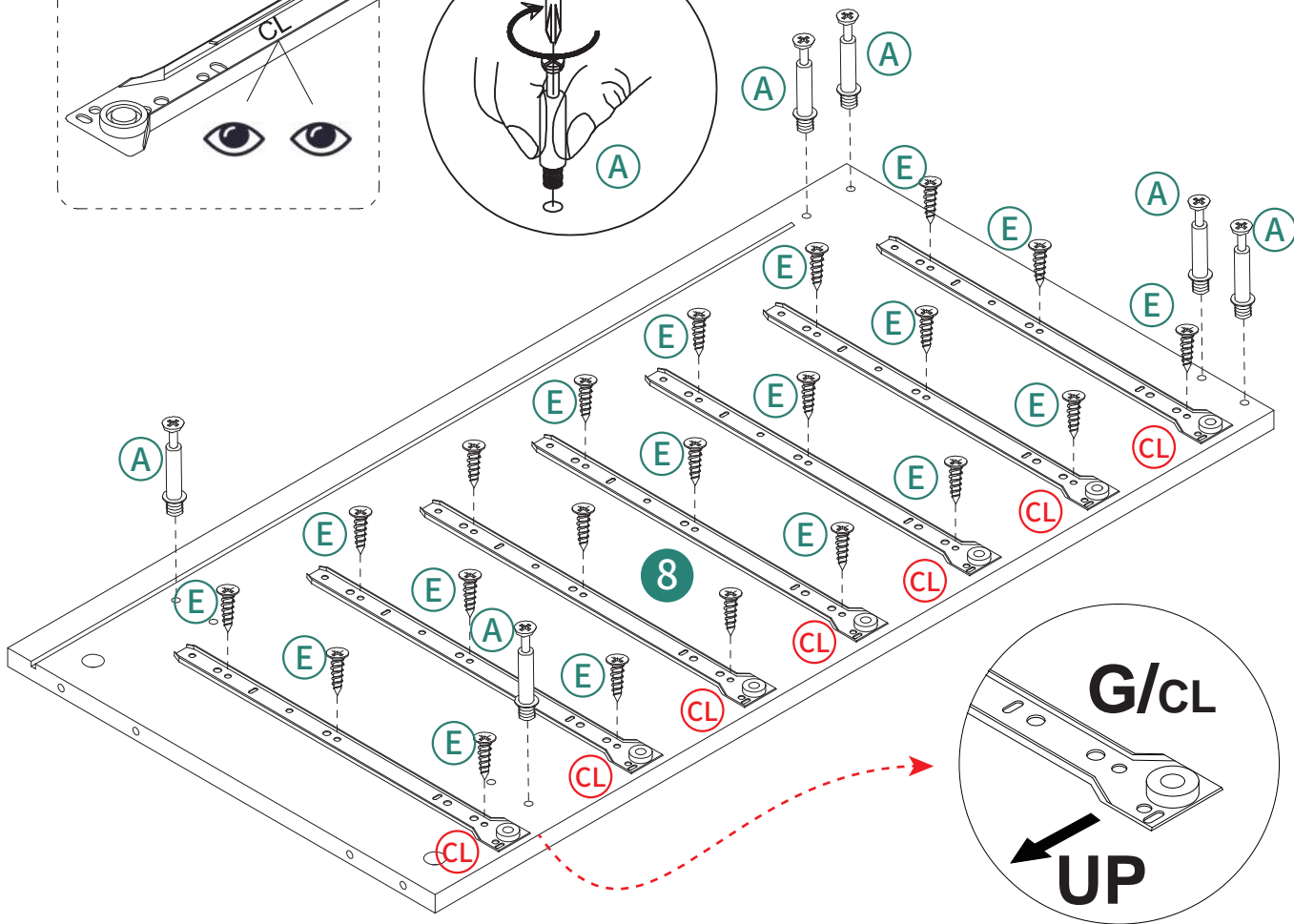
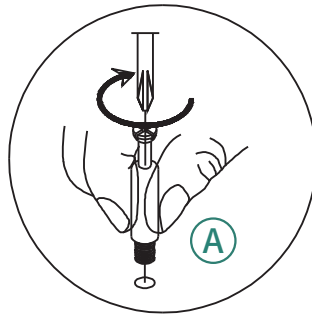
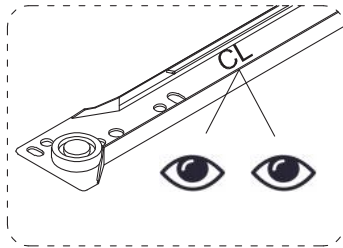

3

ST3.5X12mm

⑨1pc ④4pcs ⑬18pcs ⑥6pcs

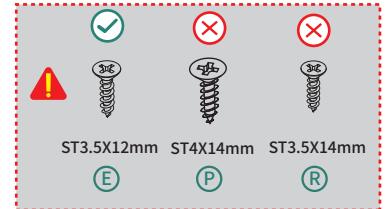
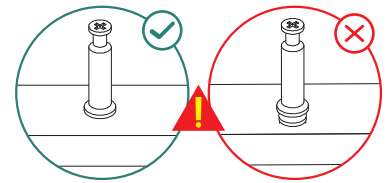
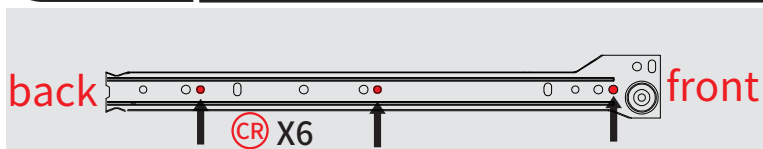

Align the screws with the center of the mounting hole of the guide rail.
 Richten Sie die Schrauben mit der Mitte des Montagelochs der Führungsschiene aus.
 Alignez les vis avec le centre du trou de montage du rail de guidage.
 Allineare le viti con il centro del foro di montaggio della guida.
 Alinee los tornillos con el centro del orificio de montaje de la guía.

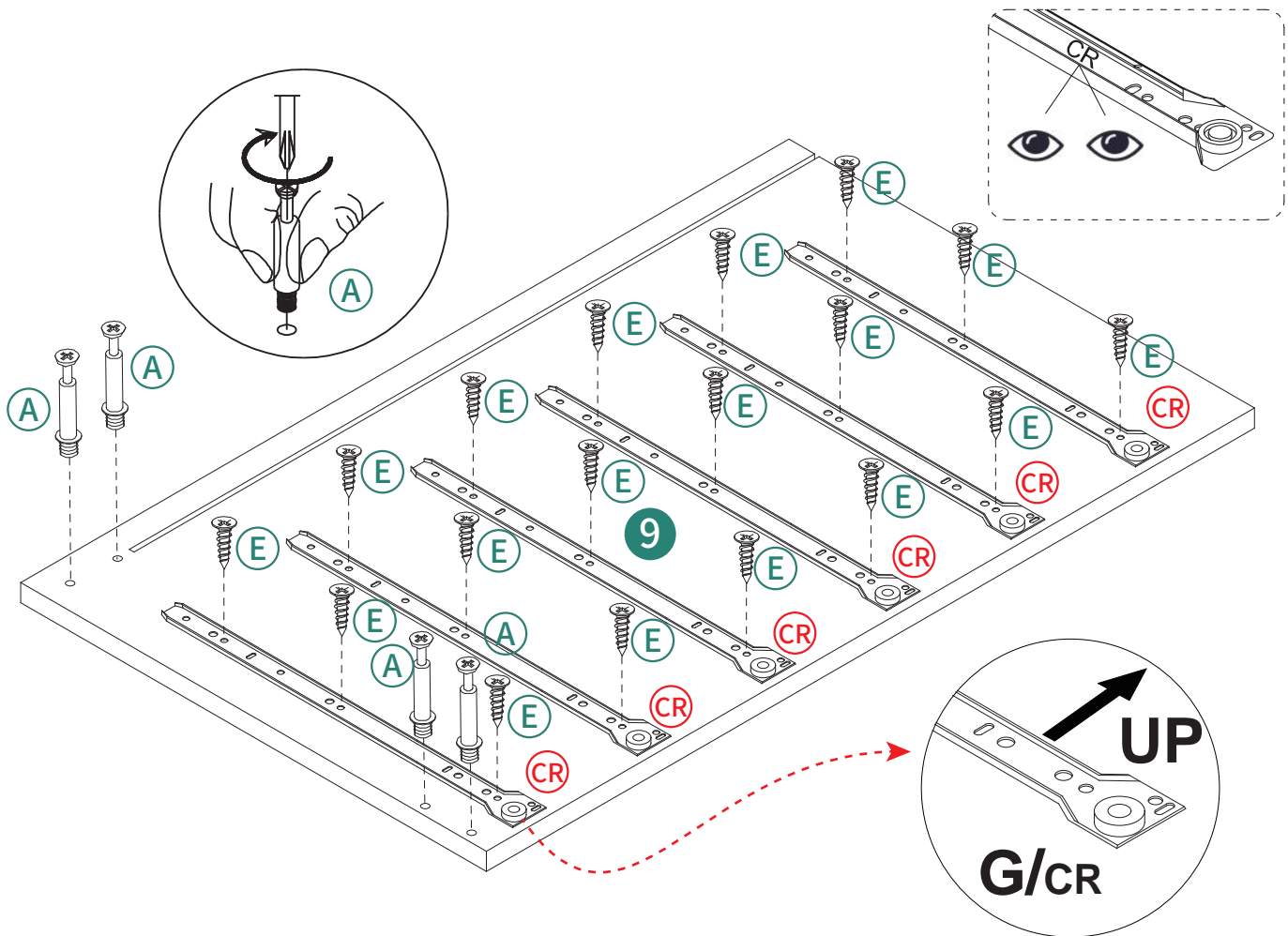

4

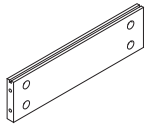

17 1pc

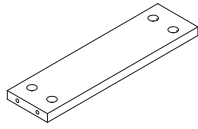

16 1pc

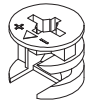

B 8pcs

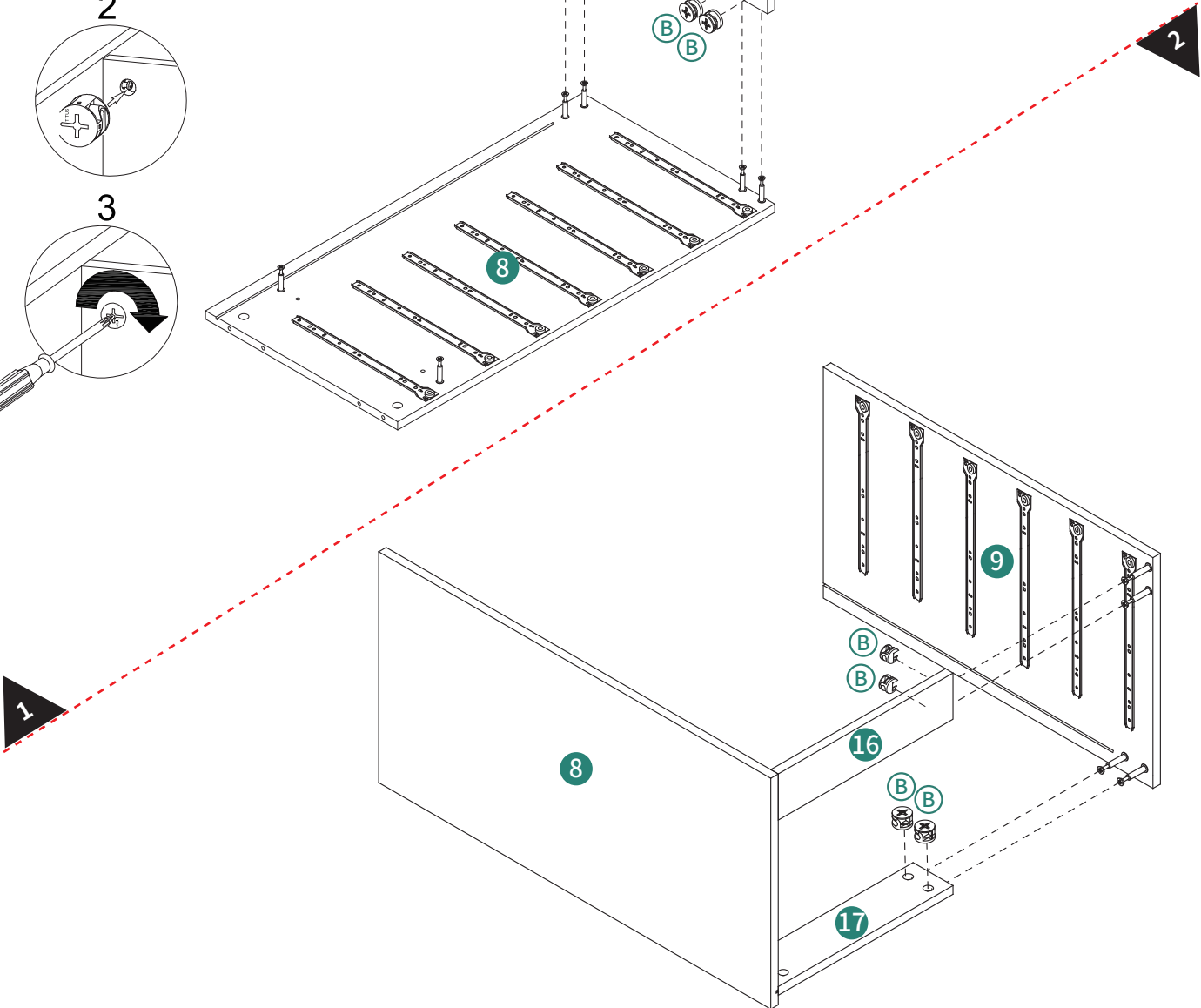
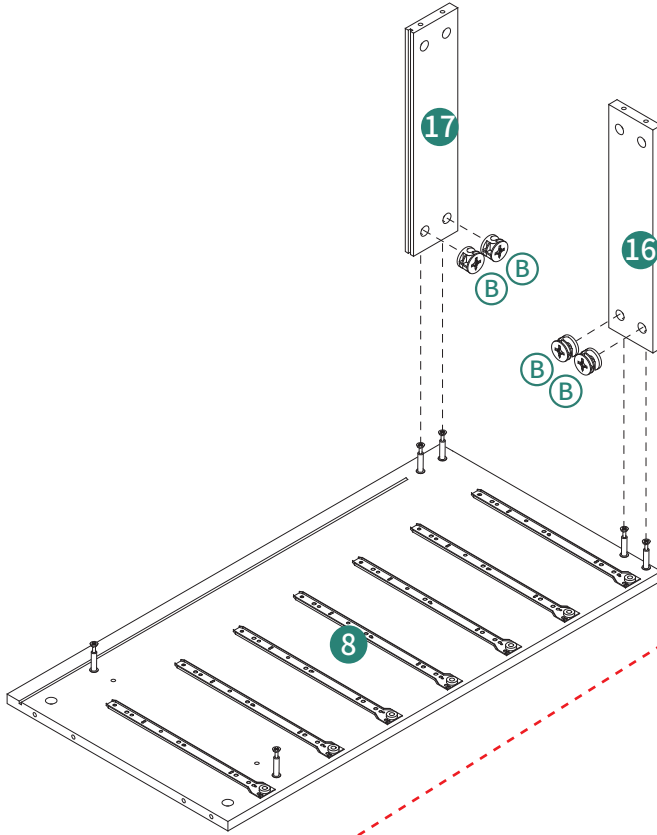
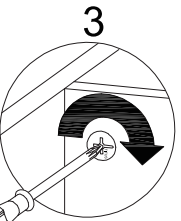
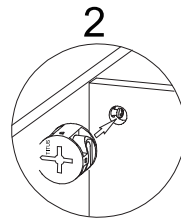
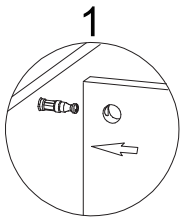

5

ST3.5X12mm

⑩1pc ④4pcs ⑮18pcs ⑥6pcs

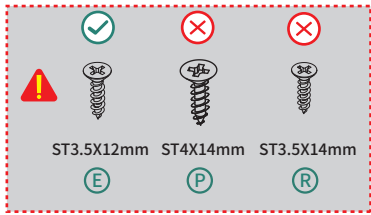
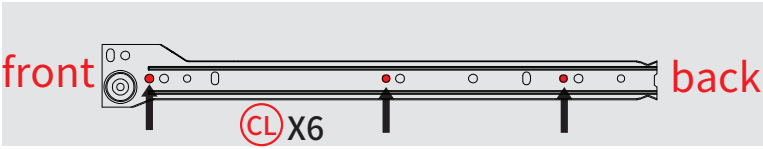
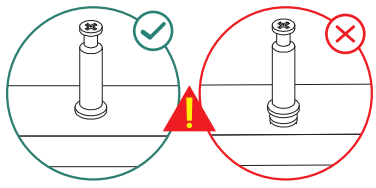

Align the screws with the center of the mounting hole of the guide rail.
 Richten Sie die Schrauben mit der Mitte des Montagelochs der Führungsschiene aus.
 Alignez les vis avec le centre du trou de montage du rail de guidage.
 Allineare le viti con il centro del foro di montaggio della guida.
 Alinee los tornillos con el centro del orificio de montaje de la guía.

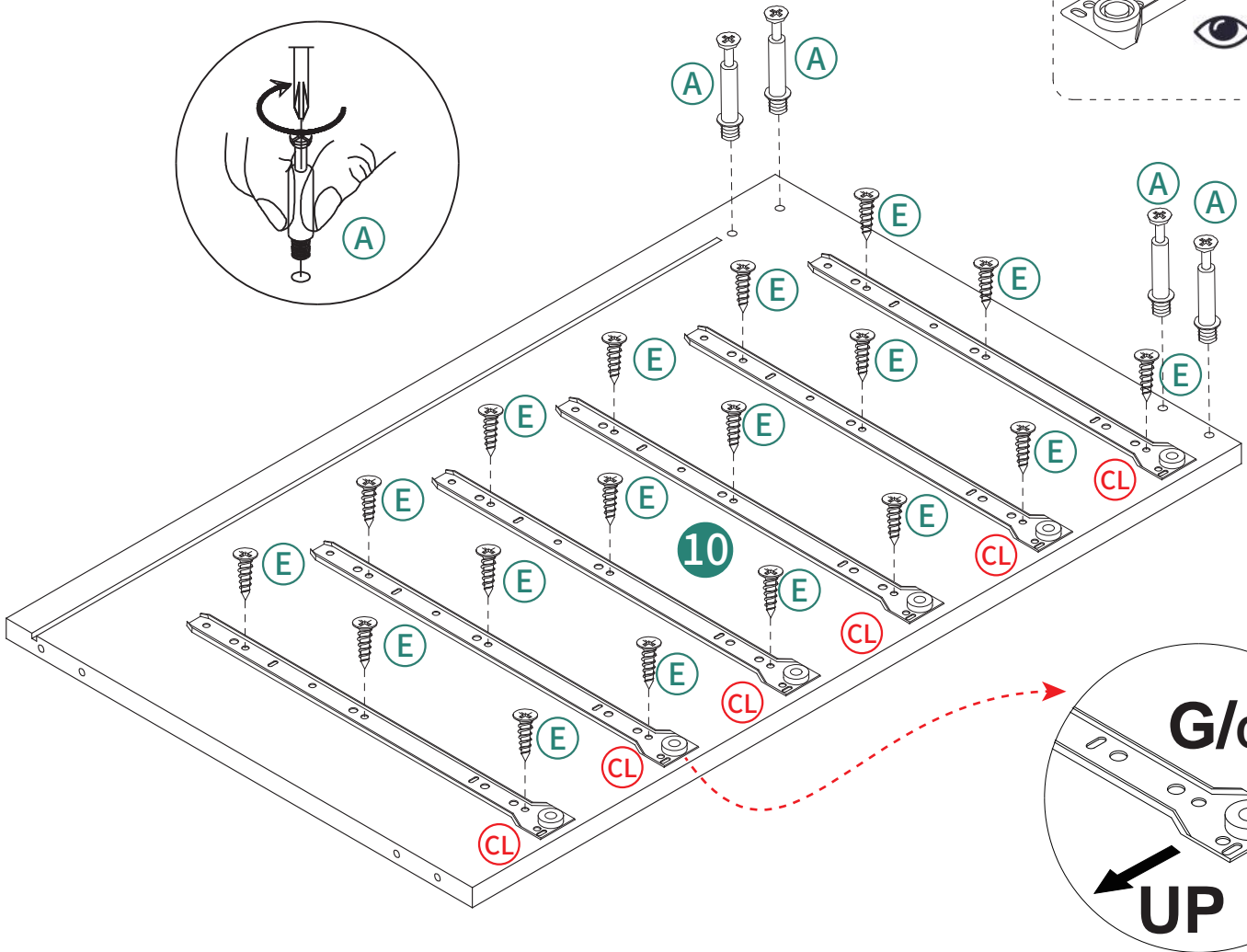
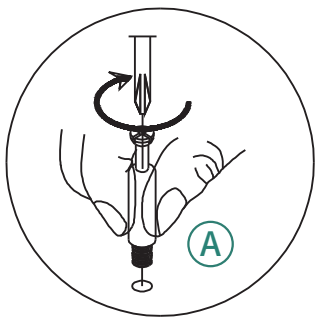
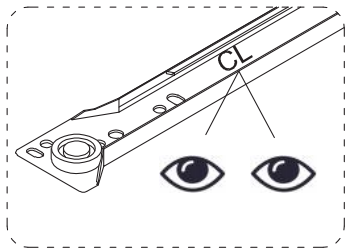

6

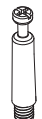
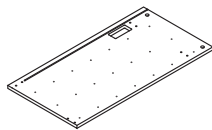

ST3.5X12mm

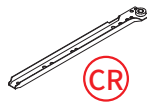

①1pc ①A6pcs ①E21pcs ①G7pcs

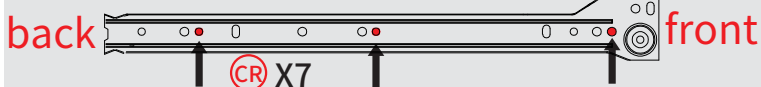
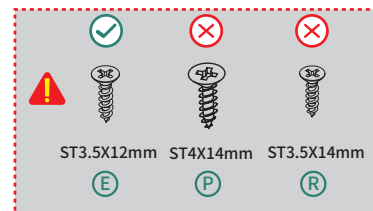
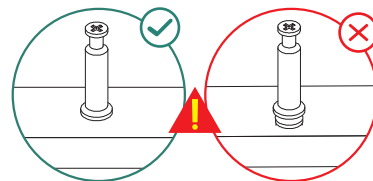

Align the screws with the center of the mounting hole of the guide rail.
Richten Sie die Schrauben mit der Mitte des Montagelochs der Führungsschiene aus.
Alignez les vis avec le centre du trou de montage du rail de guidage.
Allineare le viti con il centro del foro di montaggio della guida.
Alinee los tornillos con el centro del orificio de montaje de la guía.

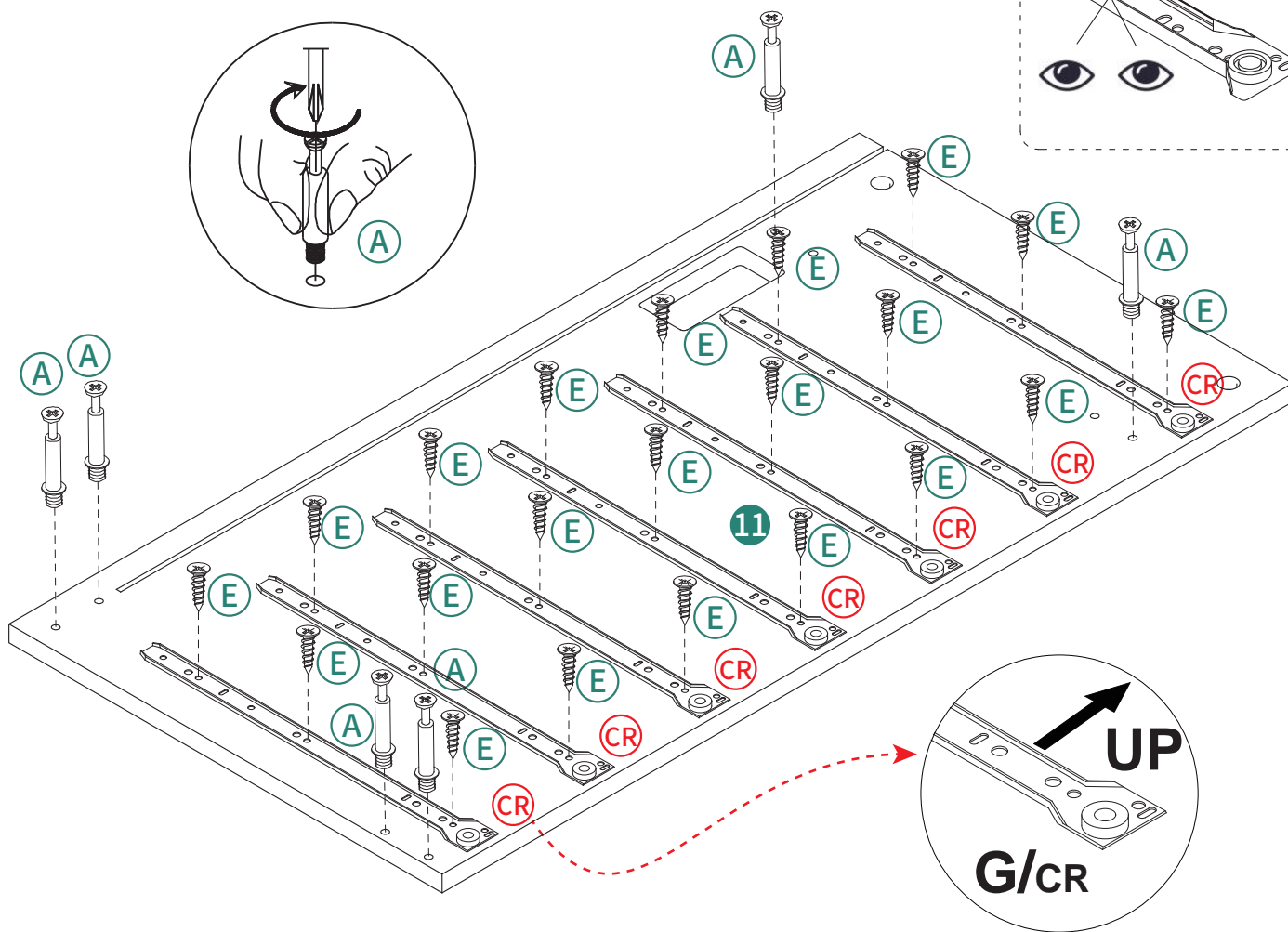
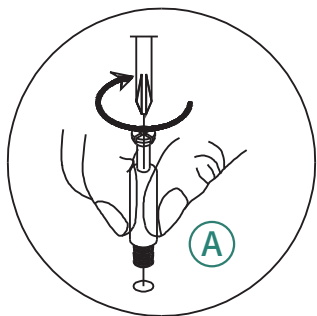

7

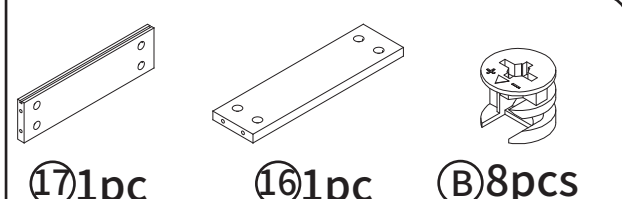

①71pc ①61pc Ⓑ8pcs

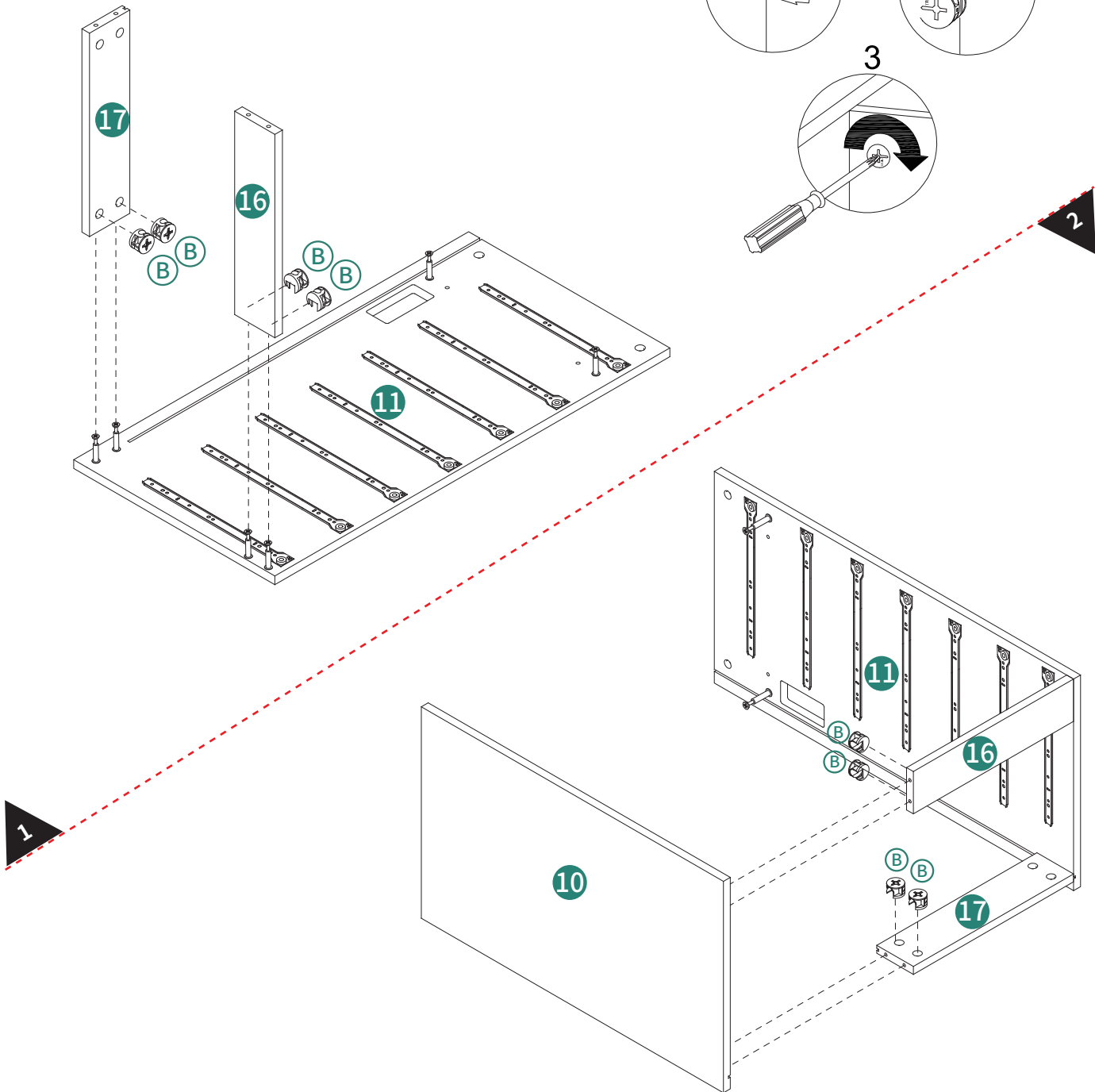
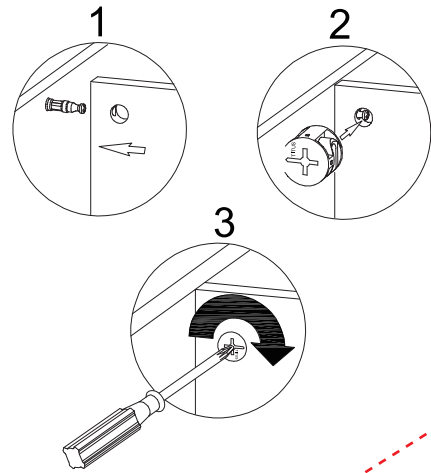

8

⑱1pc ⑲1pc

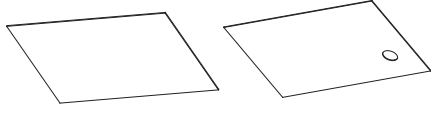
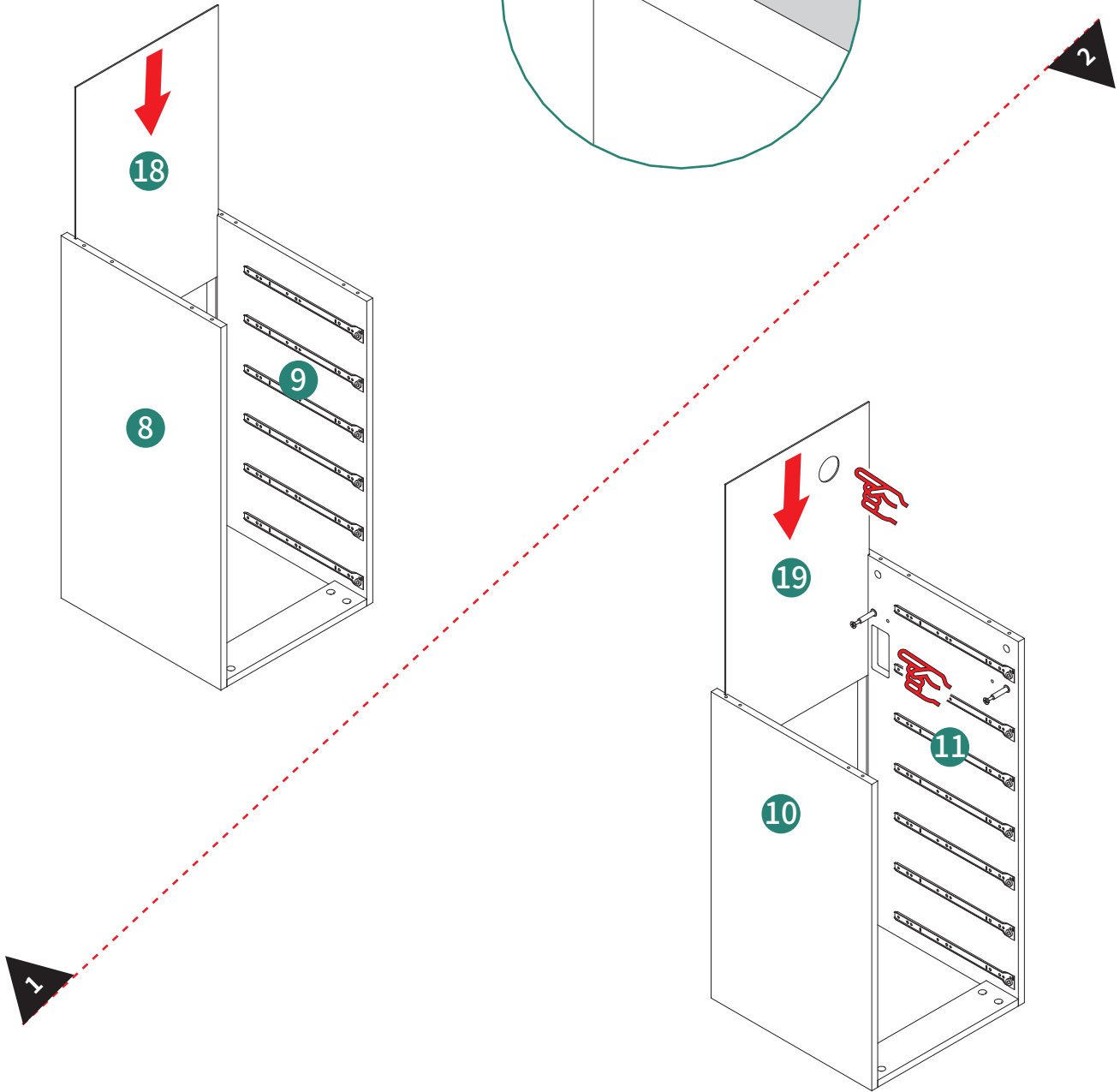
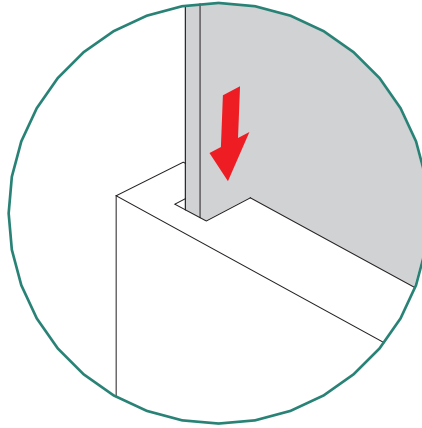
Two flat rectangular panels are shown. The left panel is labeled 18 and the right panel is labeled 19. Both labels are circled in green.

9
X2

ST3.5X12mm

12 2pcs E 12pcs G 2pcs

CL CR

ST3.5X12mm ST4X14mm ST3.5X14mm

E P R

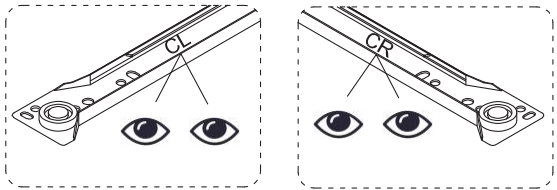
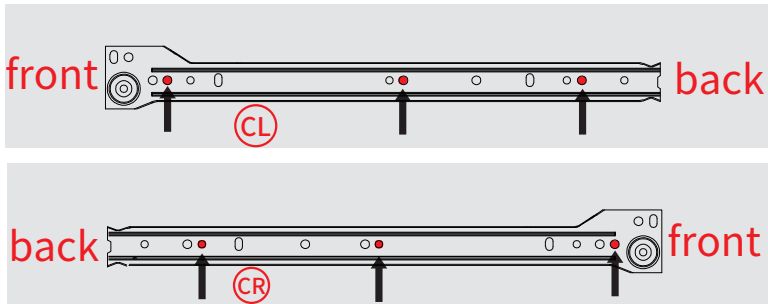

Align the screws with the center of the mounting hole of the guide rail.
 Richten Sie die Schrauben mit der Mitte des Montagelochs der Führungsschiene aus.
 Alignez les vis avec le centre du trou de montage du rail de guidage.
 Allineare le viti con il centro del foro di montaggio della guida.
 Alinee los tornillos con el centro del orificio de montaje de la guía.

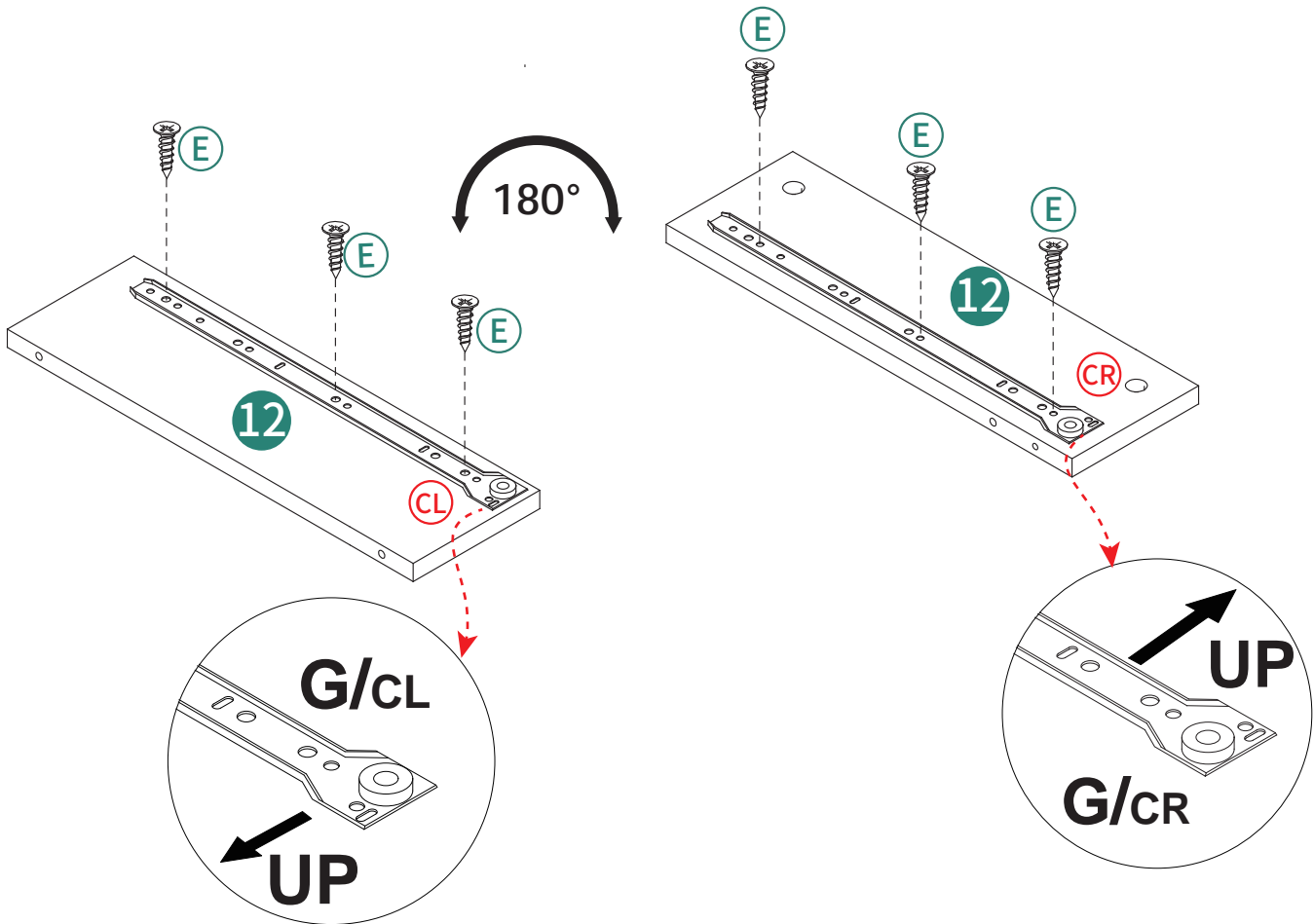

10

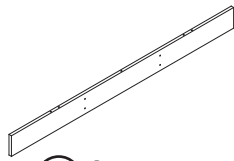

⑬1pc

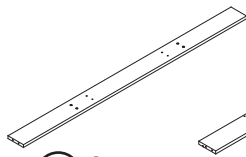

⑭1pc

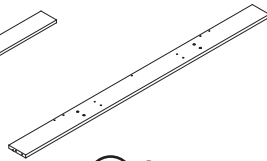

⑮1pc

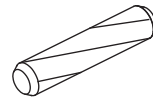

Ⓒ8pcs

ST4X40mm



Ⓓ11pcs

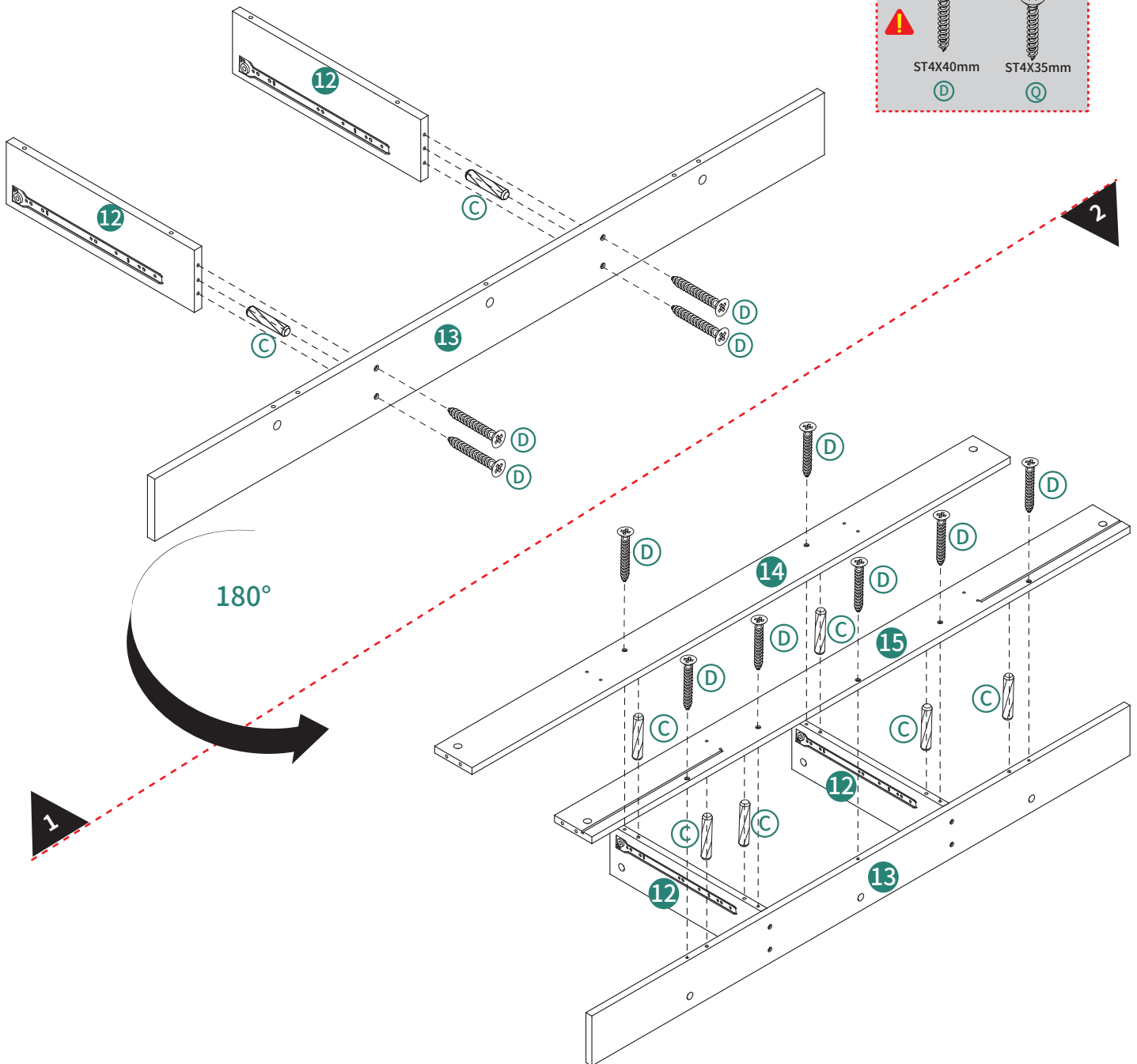
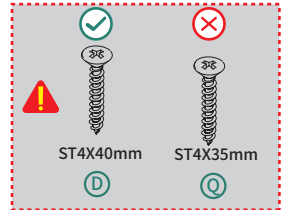

11

Ⓑ 4pcs

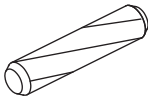

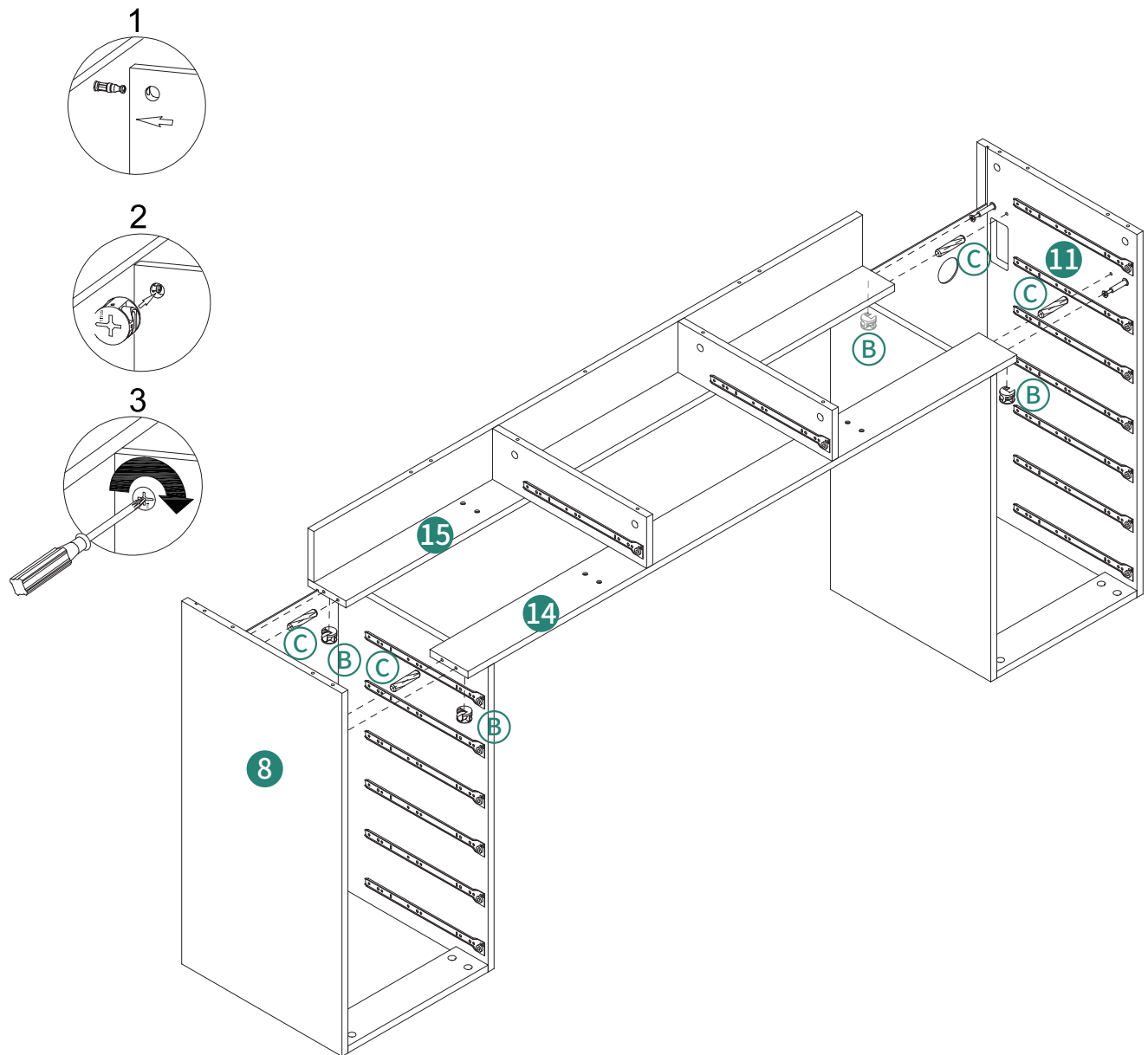
Ⓒ 4pcs

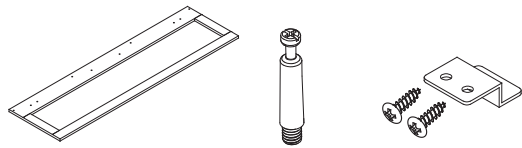

13

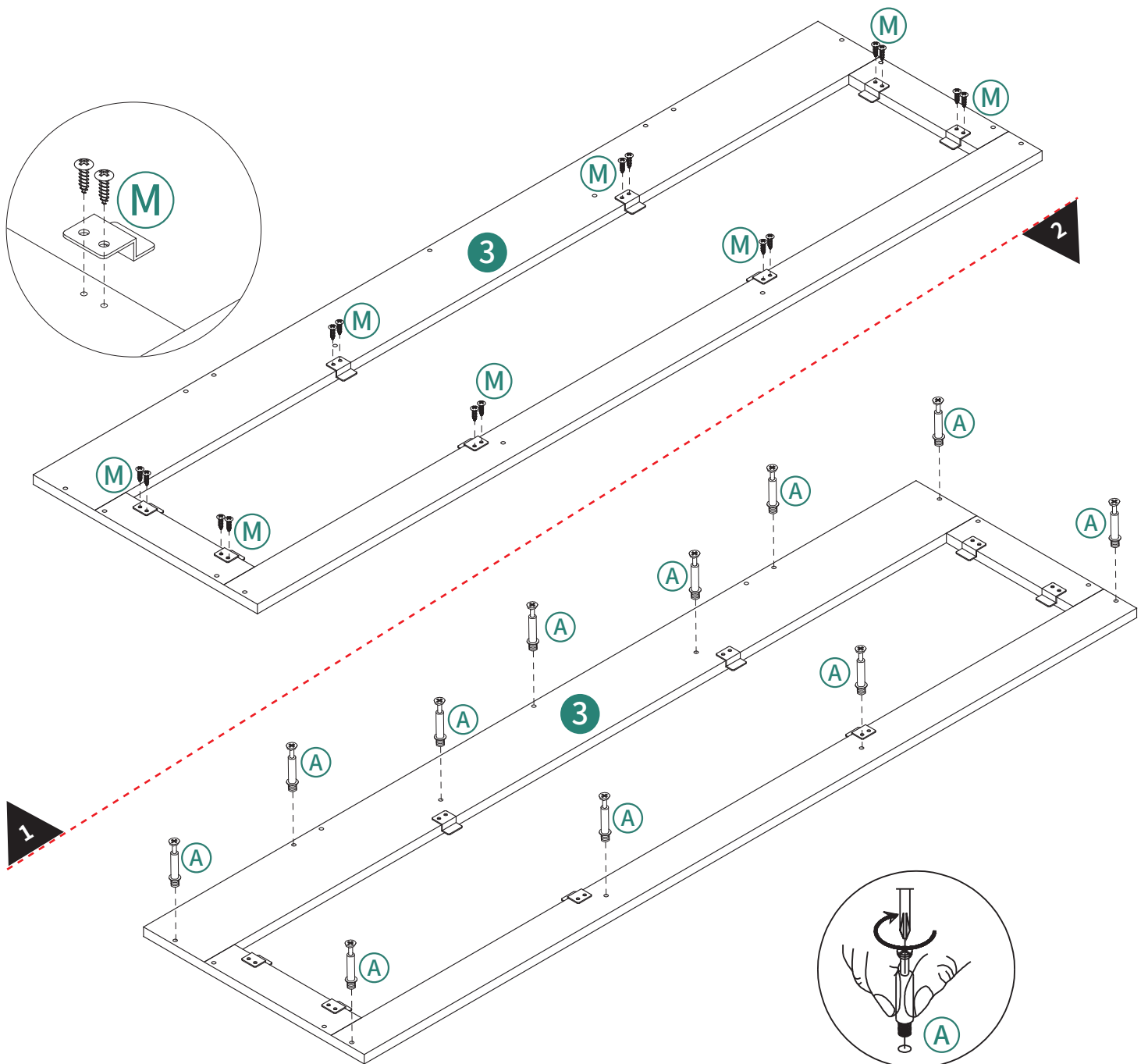
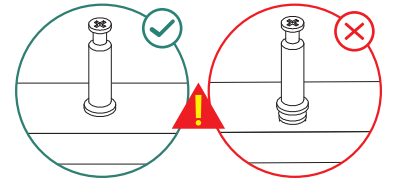

③ 1pc ① 11pcs ② 8pcs



14

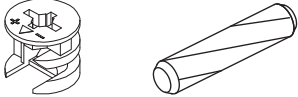

B 11pcs **C** 6pcs

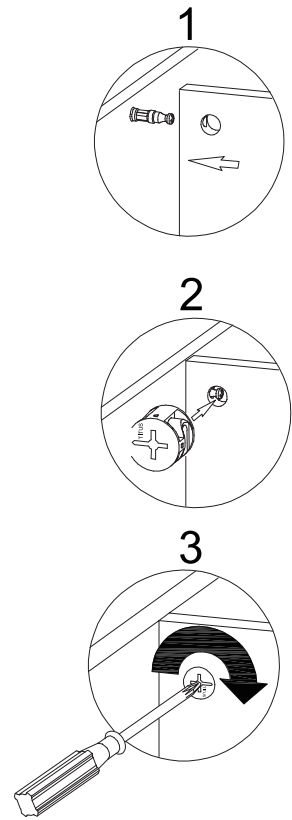
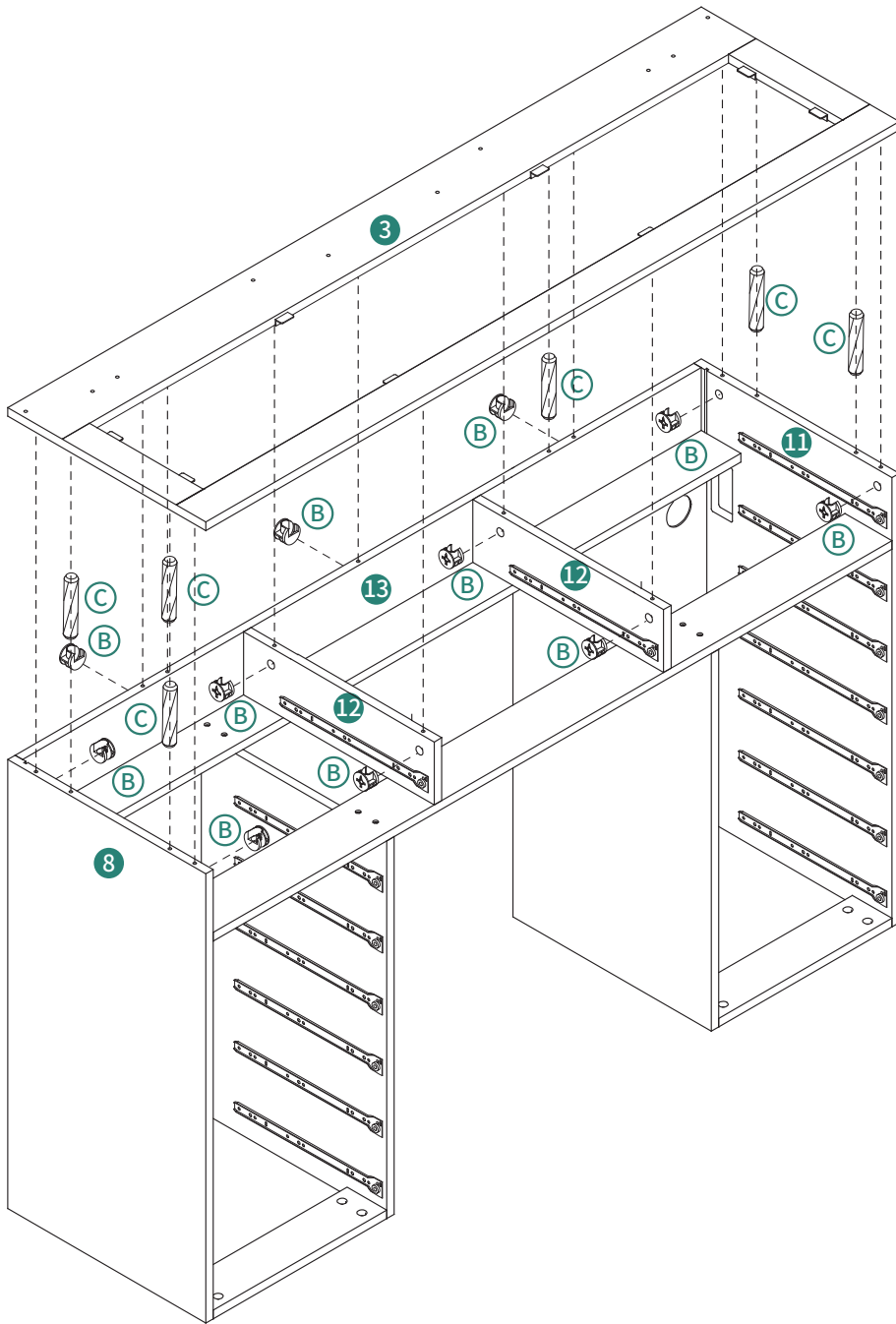
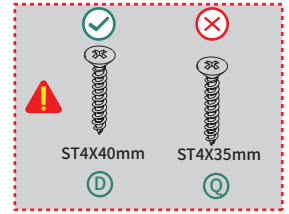

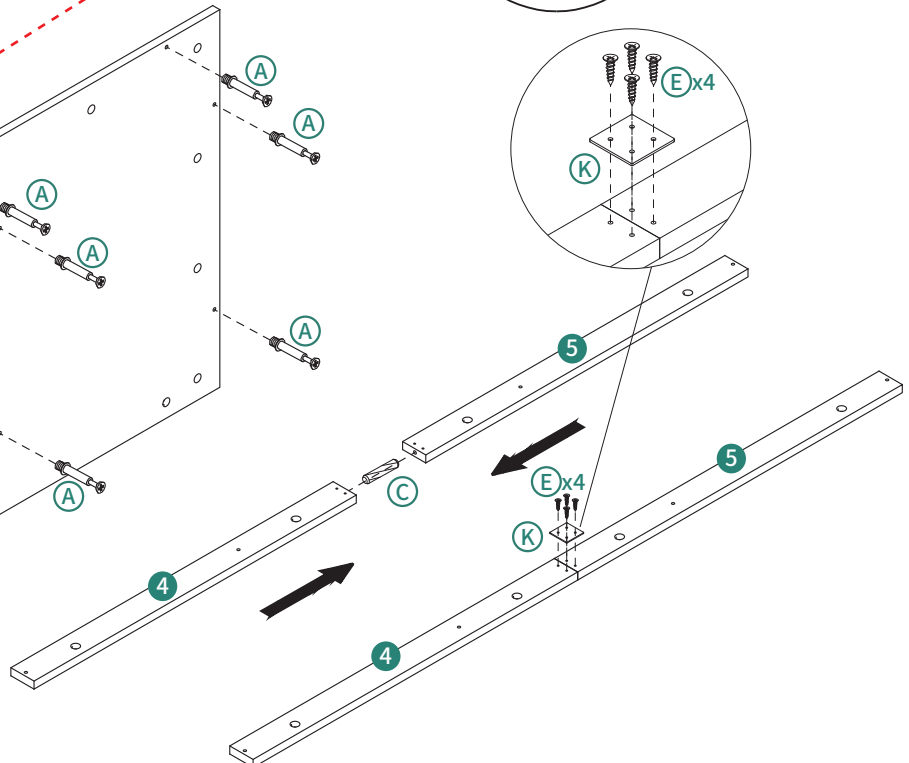
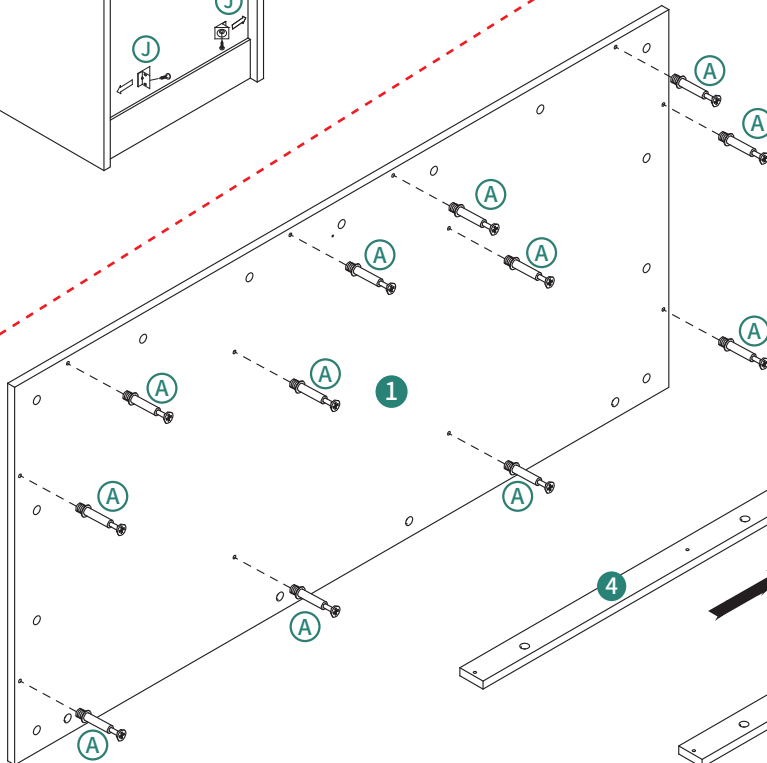
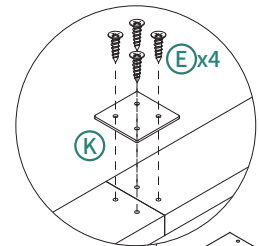
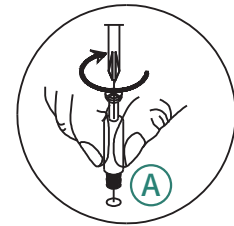
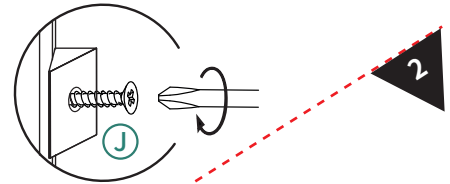
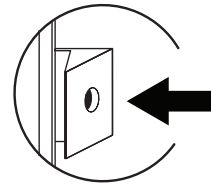
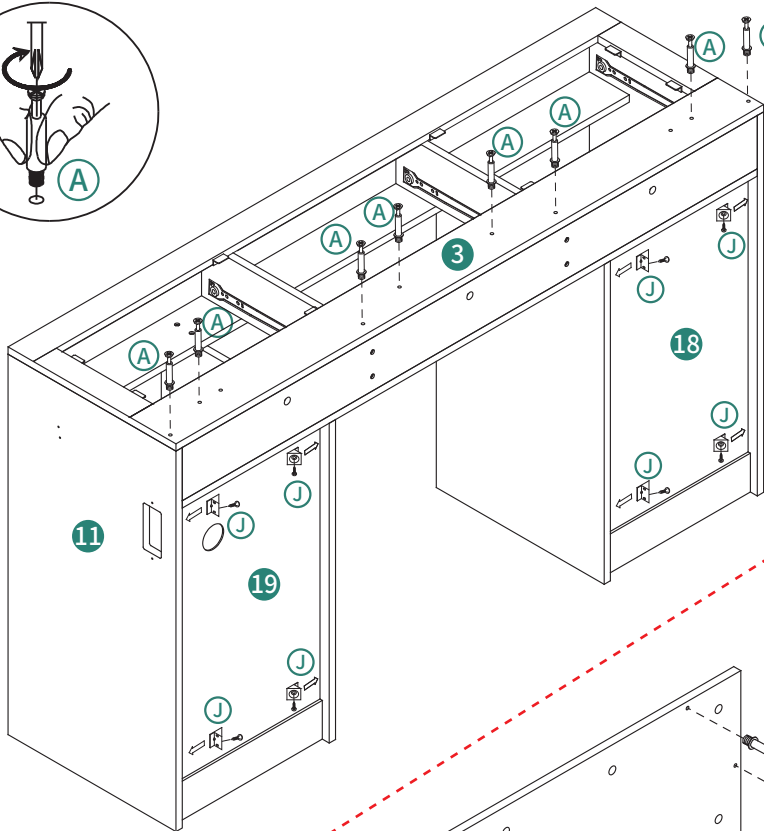
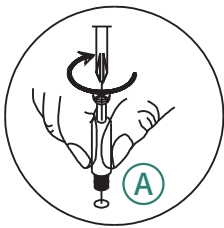

15

- ① 1pc
- ④ 1pc
- ⑤ 1pc
- Ⓐ 20pcs
- Ⓒ 1pc
- Ⓙ 8pcs
- Ⓔ 4pcs
- Ⓚ 1pc

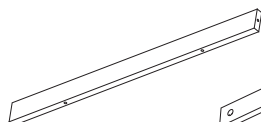
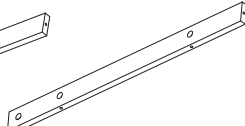
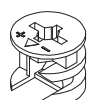

16

-  ⑥ 2pcs
 -  ⑦ 2pcs
 -  ⑧ 12pcs
 -  ⑨ 4pcs
- ST4X40mm

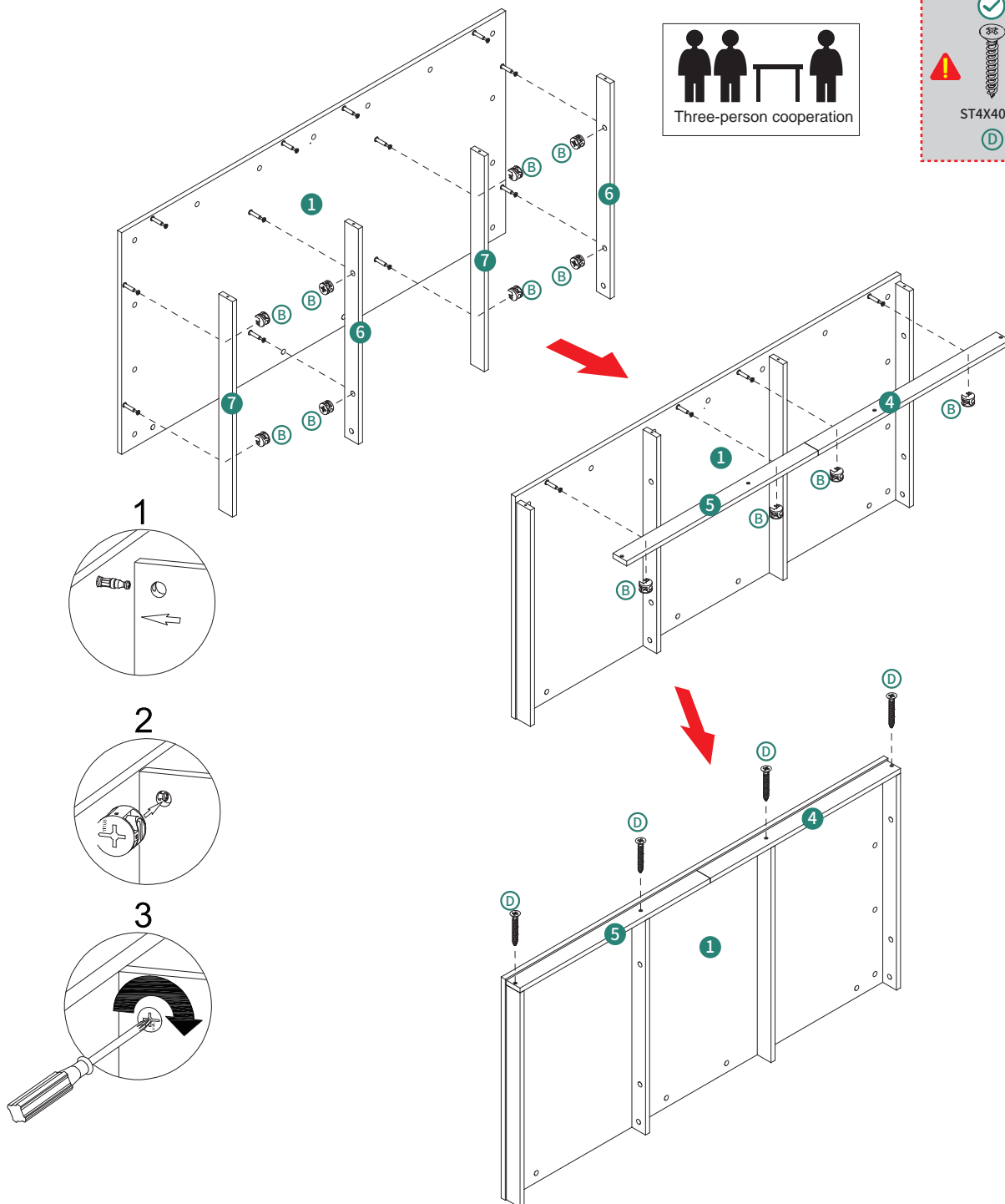

17

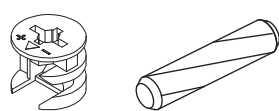

(B) 8pcs (C) 2pcs

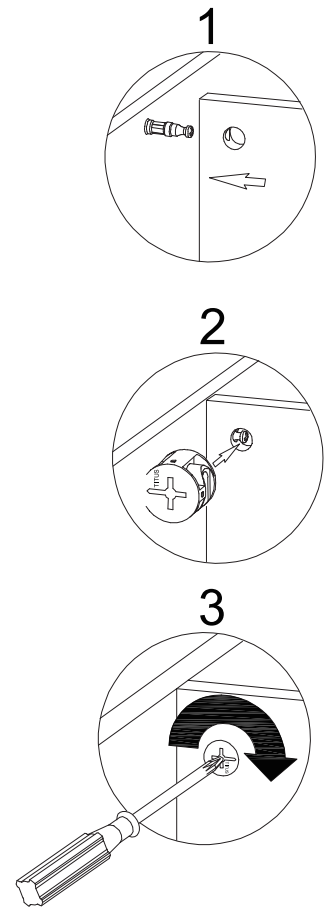
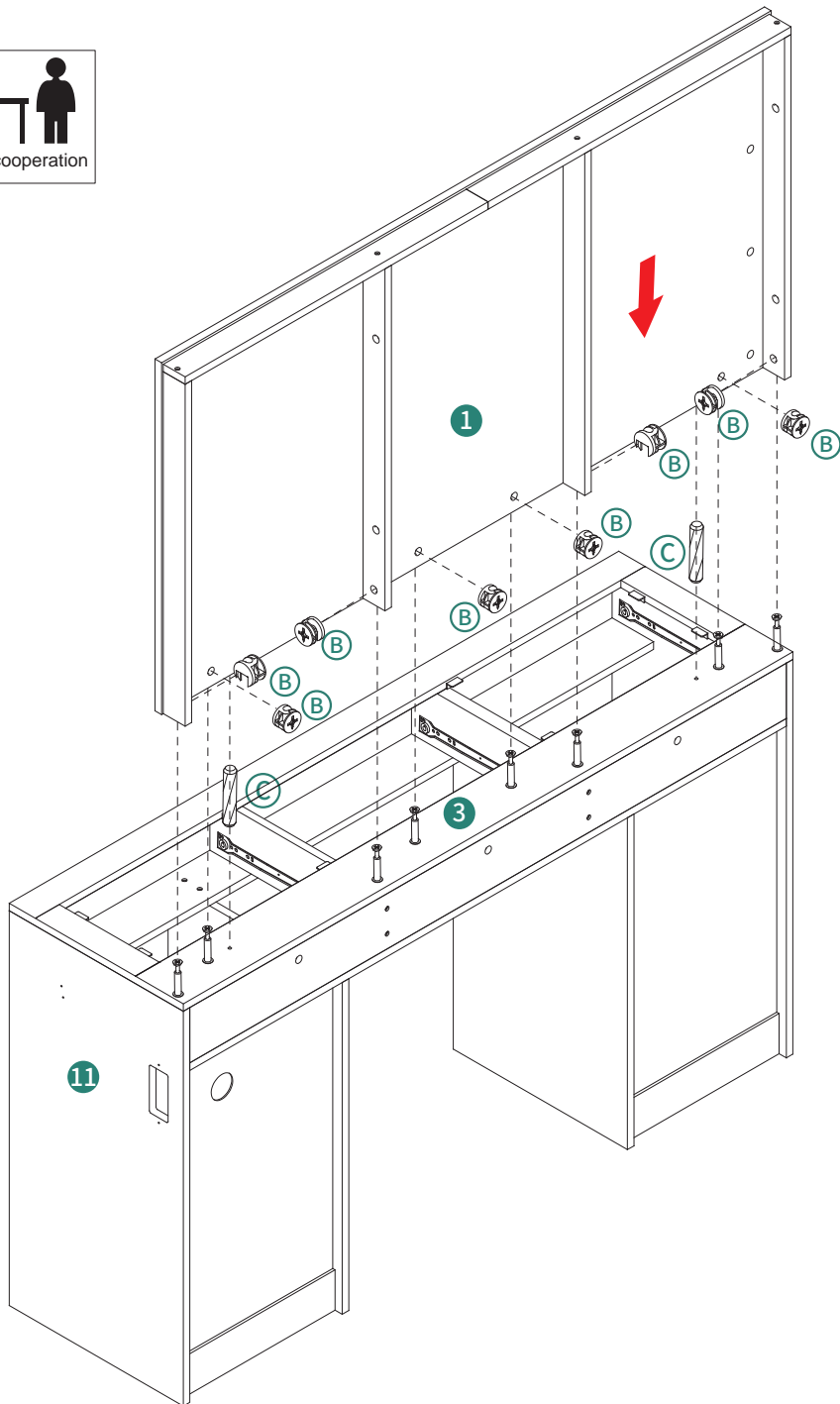
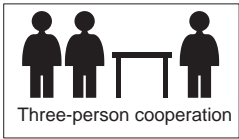

18

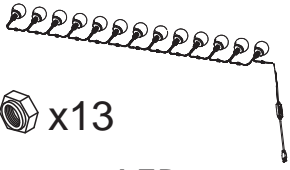

x13

LED

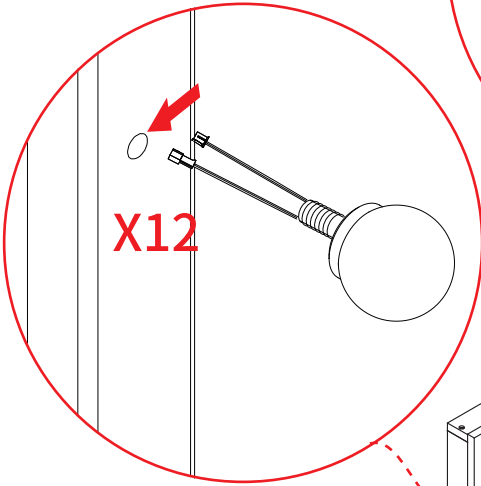
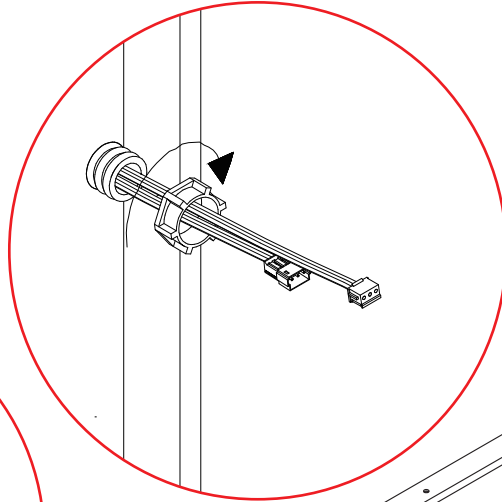

X12

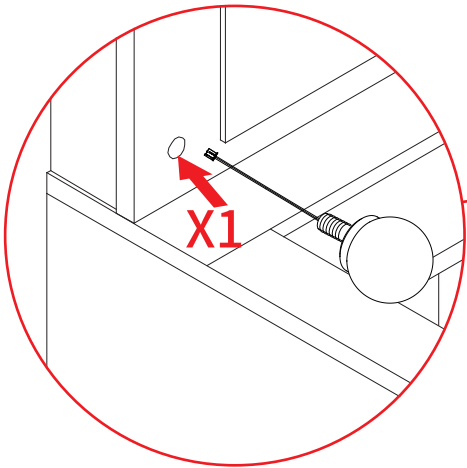

X1

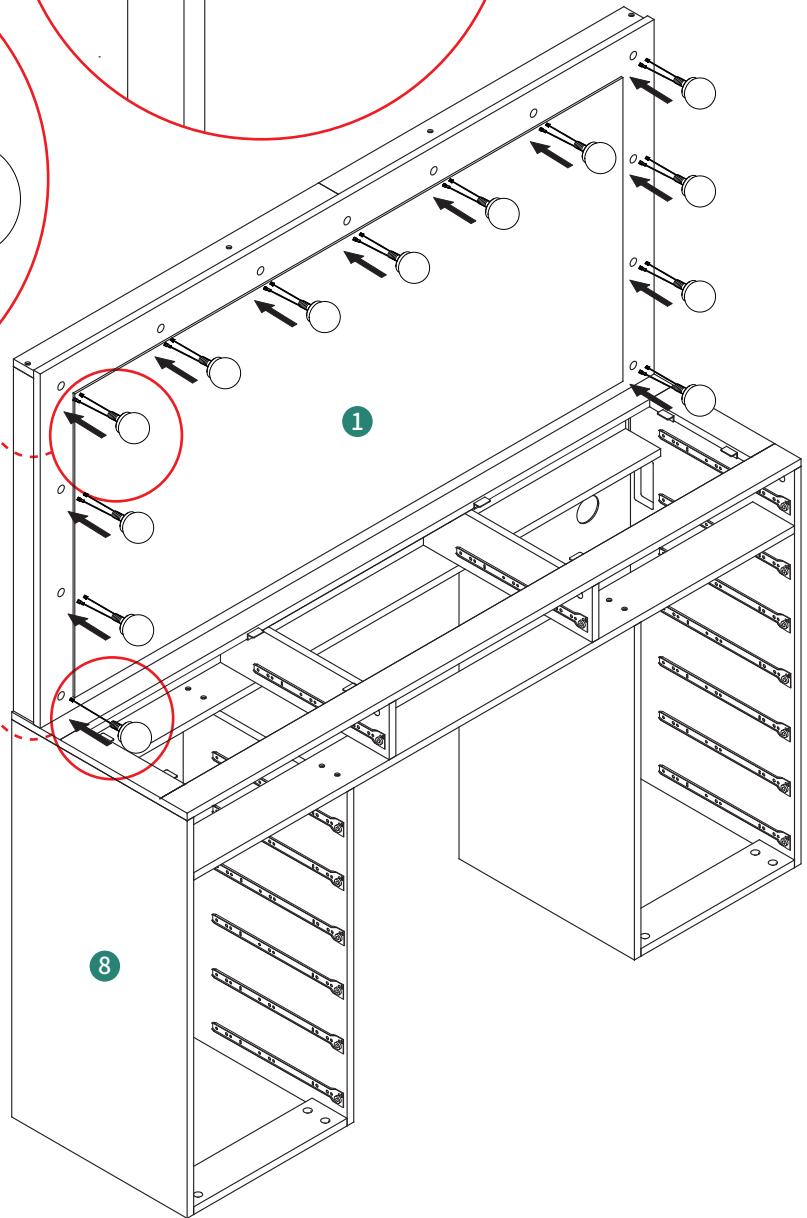

19

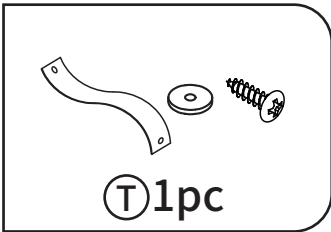

T 1pc

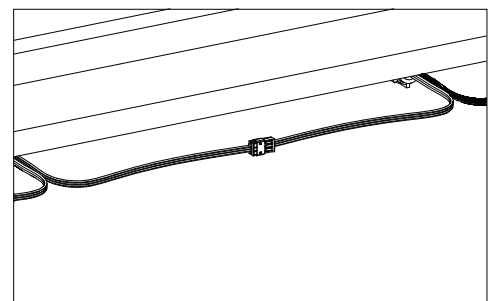
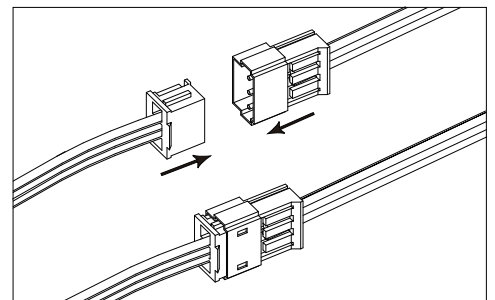
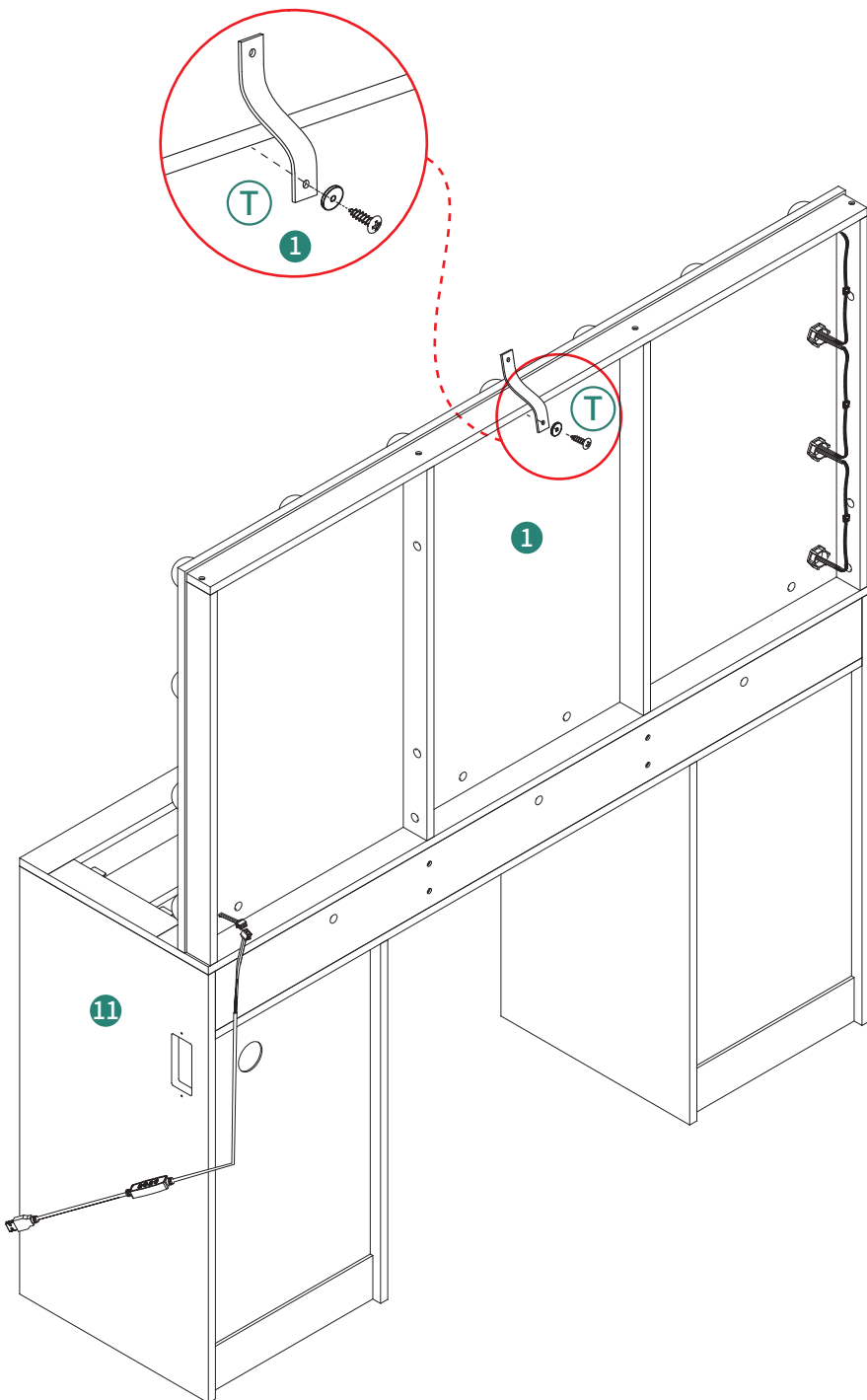

20

ST3.5X14mm



(R) 4pcs



(H) 1pc

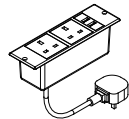

(I) 1pc

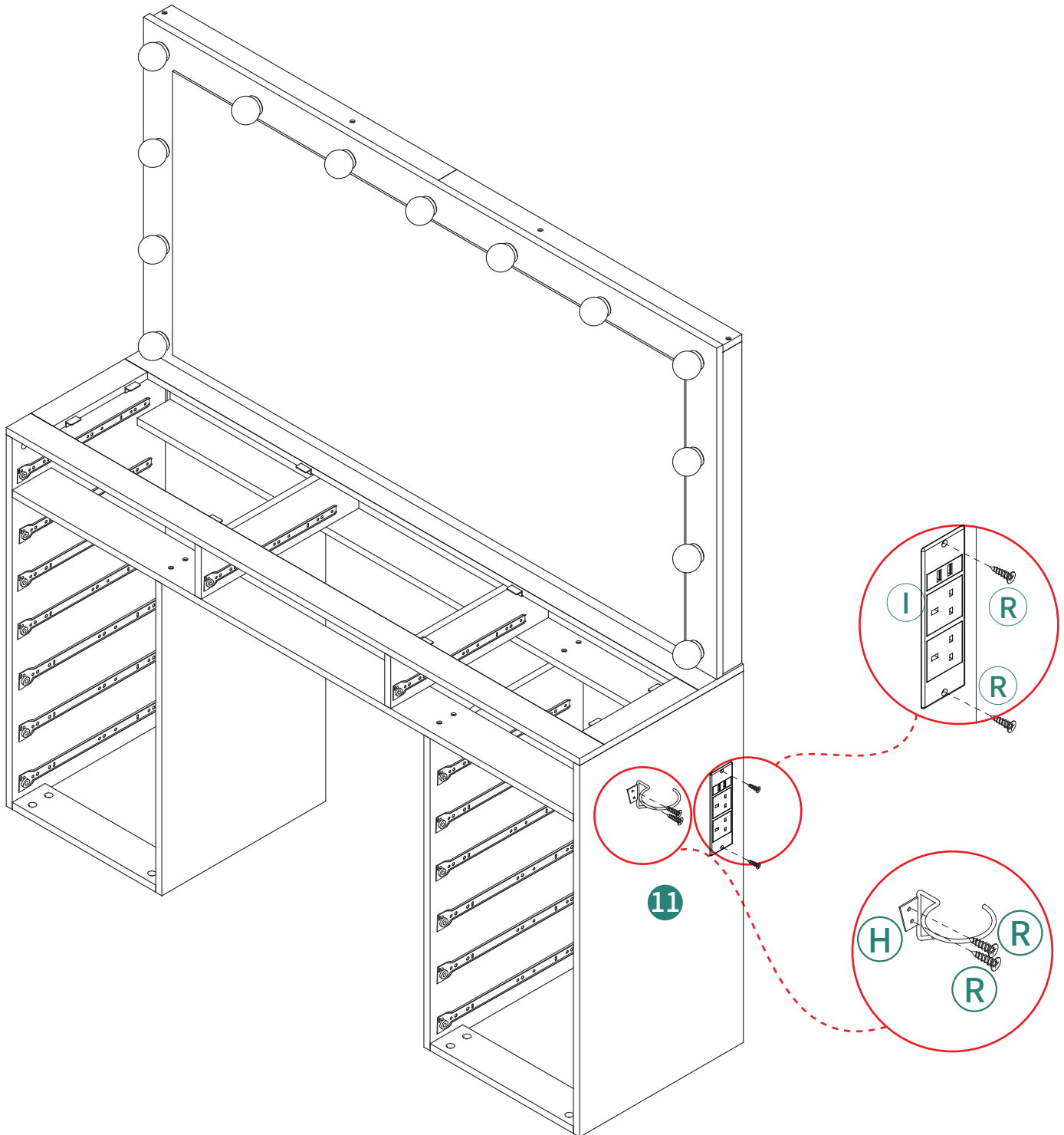
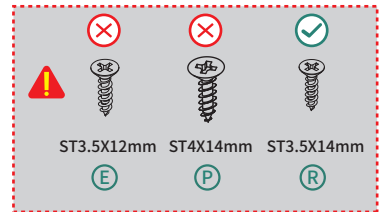

21
X3

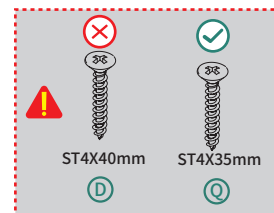
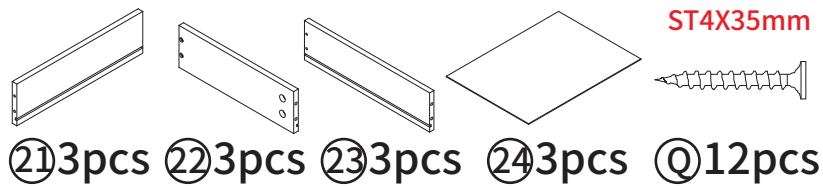

Note: Make sure the positions marked by triangles are facing the same direction.

Hinweis: Stellen Sie sicher, dass die Positionen, die durch Dreiecke markiert sind, in die gleiche Richtung zeigen.

Note : Assurez-vous que les positions marquées par des triangles sont orientées dans la même direction.

Nota: Assicurati che le posizioni contrassegnate da triangoli siano rivolte nella stessa direzione.

Nota: Asegúrate de que las posiciones marcadas con triángulos estén orientadas en la misma dirección.

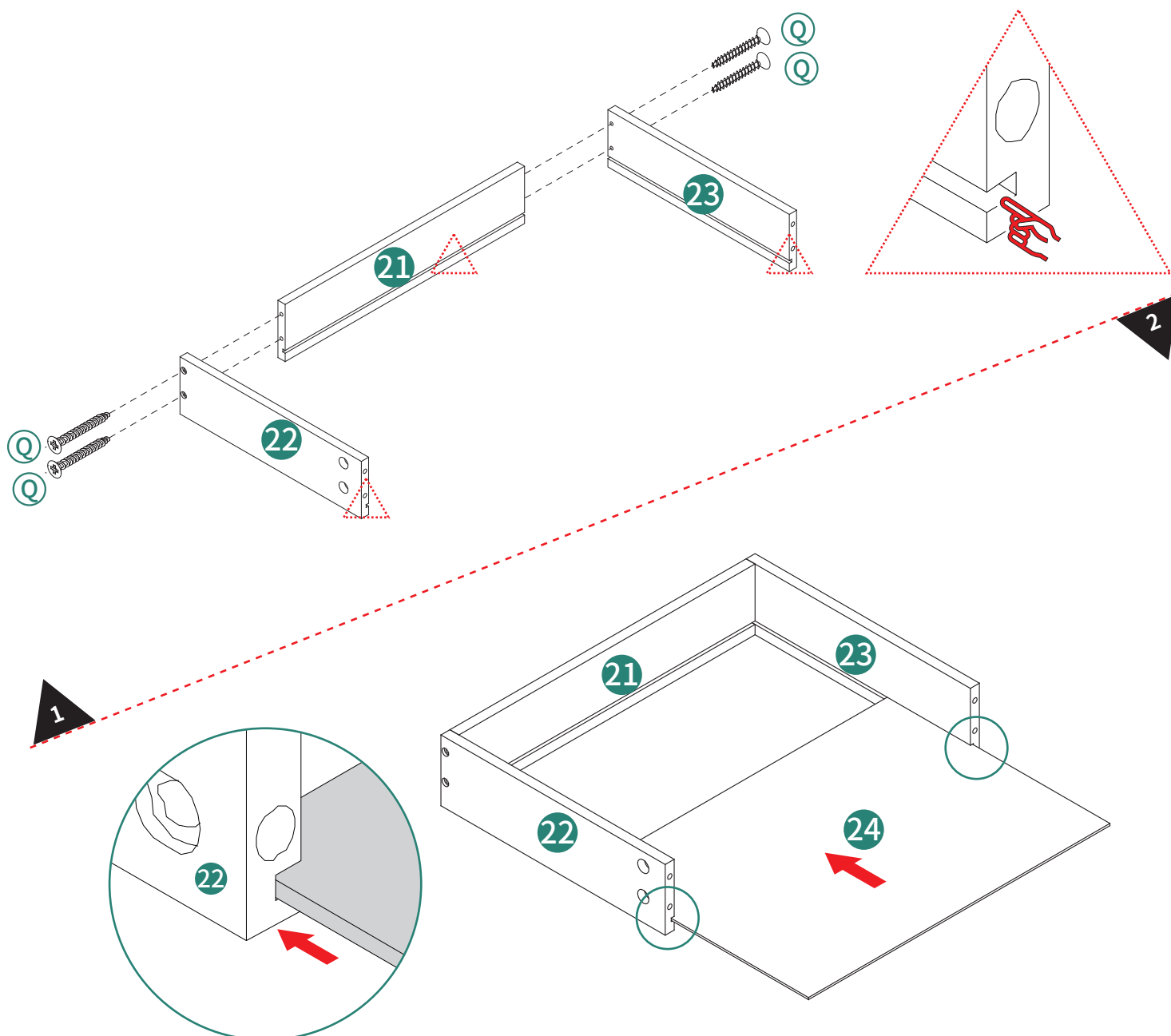

22
X3

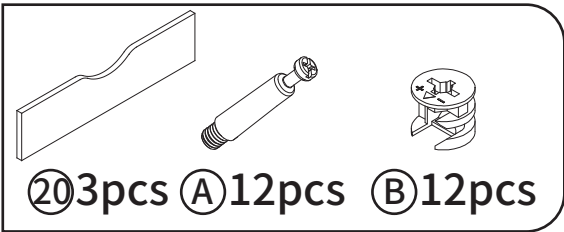

②0 3pcs ①A 12pcs ①B 12pcs

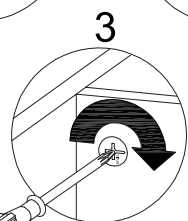
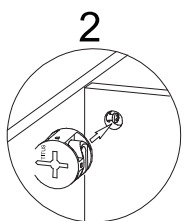
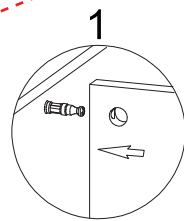
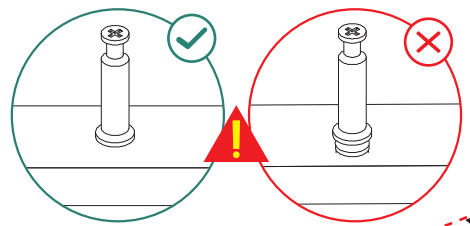
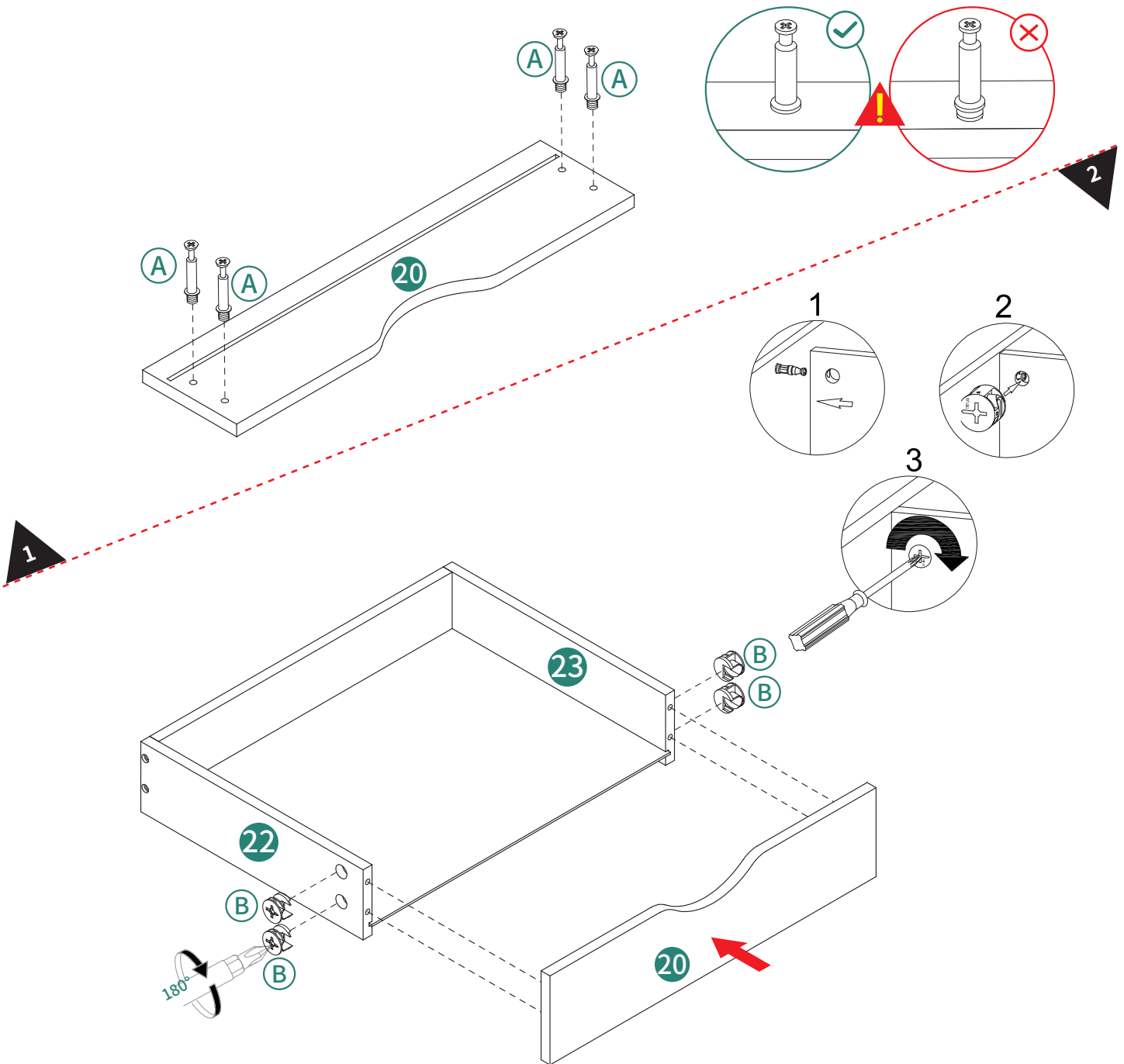

23
X3

ST3.5X12mm
E 12pcs

DL DR
G 3pcs

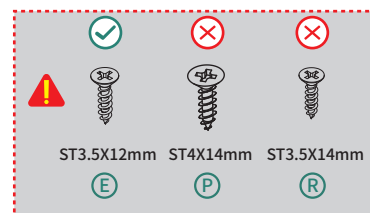

Align the screws with the center of the mounting hole of the guide rail.
 Richten Sie die Schrauben mit der Mitte des Montagelochs der Führungsschiene aus.
 Alignez les vis avec le centre du trou de montage du rail de guidage.
 Allineare le viti con il centro del foro di montaggio della guida.
 Alinee los tornillos con el centro del orificio de montaje de la guía.

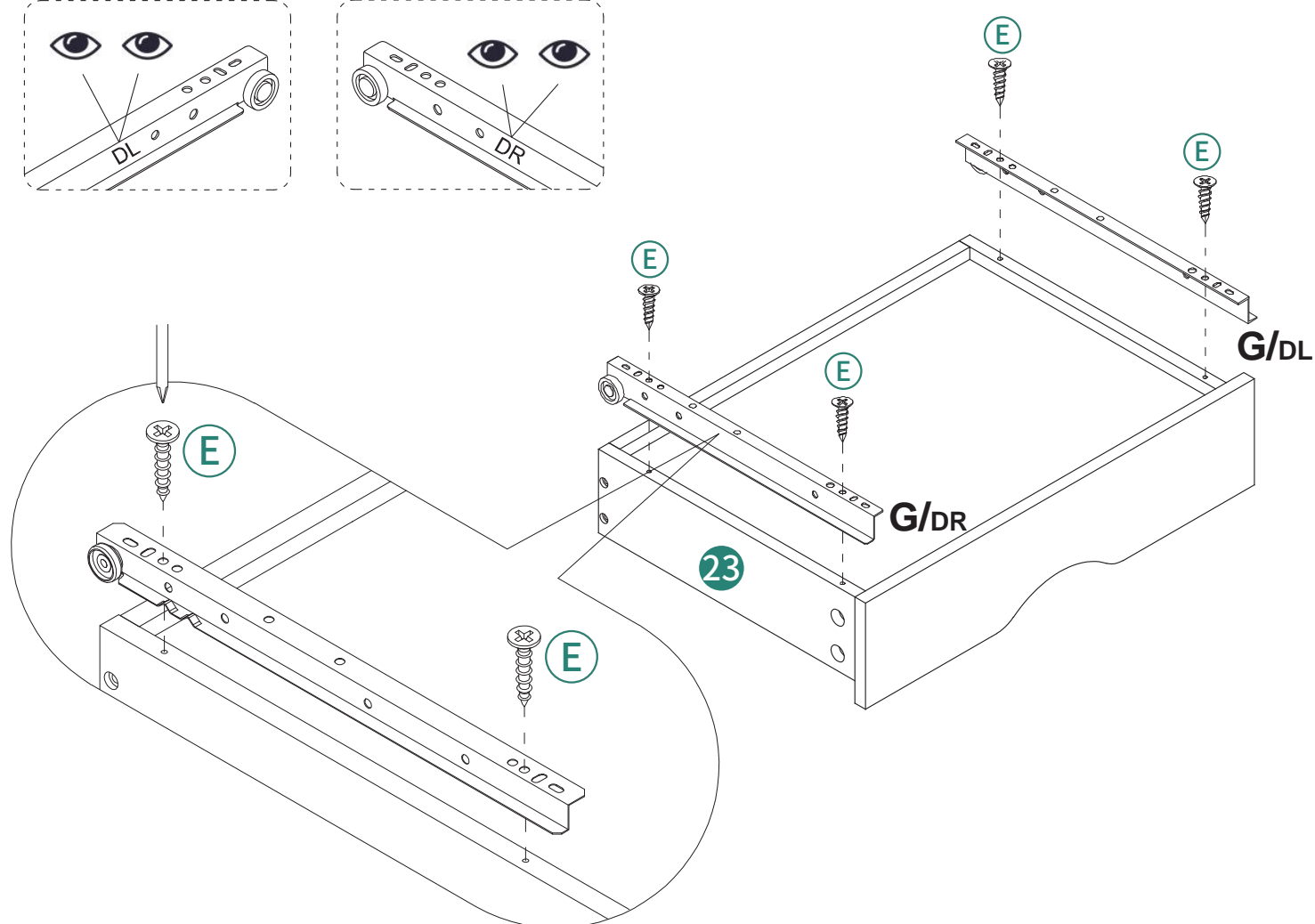
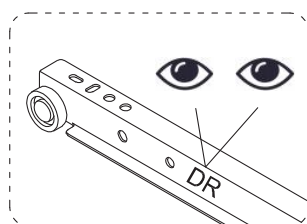
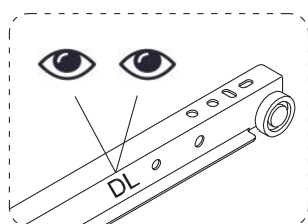

24
X12

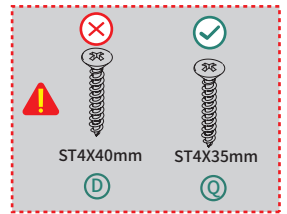
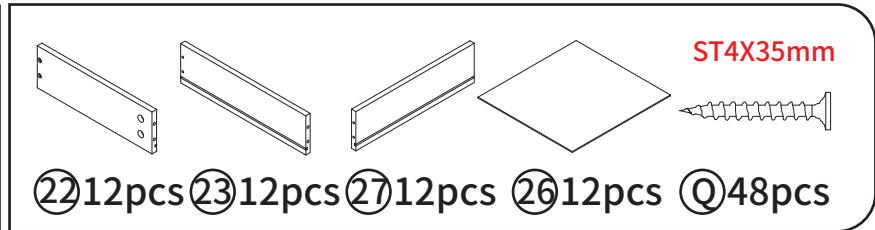

Note: Make sure the positions marked by triangles are facing the same direction.

Hinweis: Stellen Sie sicher, dass die Positionen, die durch Dreiecke markiert sind, in die gleiche Richtung zeigen.

Note : Assurez-vous que les positions marquées par des triangles sont orientées dans la même direction.

Nota: Assicurati che le posizioni contrassegnate da triangoli siano rivolte nella stessa direzione.

Nota: Asegúrate de que las posiciones marcadas con triángulos estén orientadas en la misma dirección.

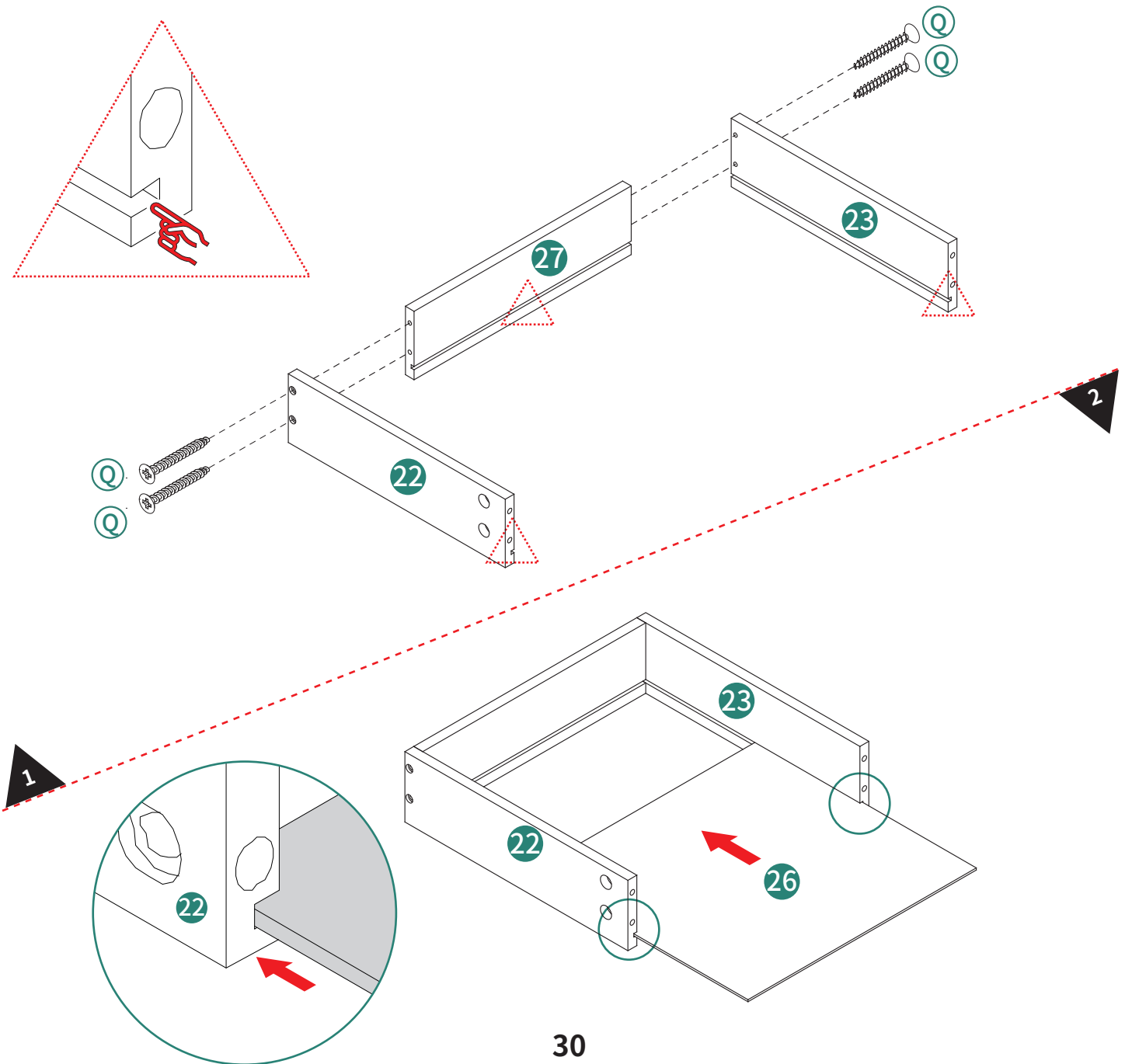

25
X12

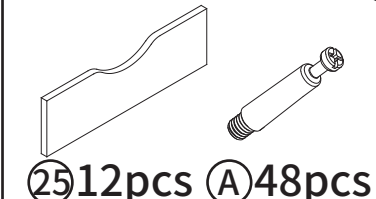

25 12pcs A 48pcs

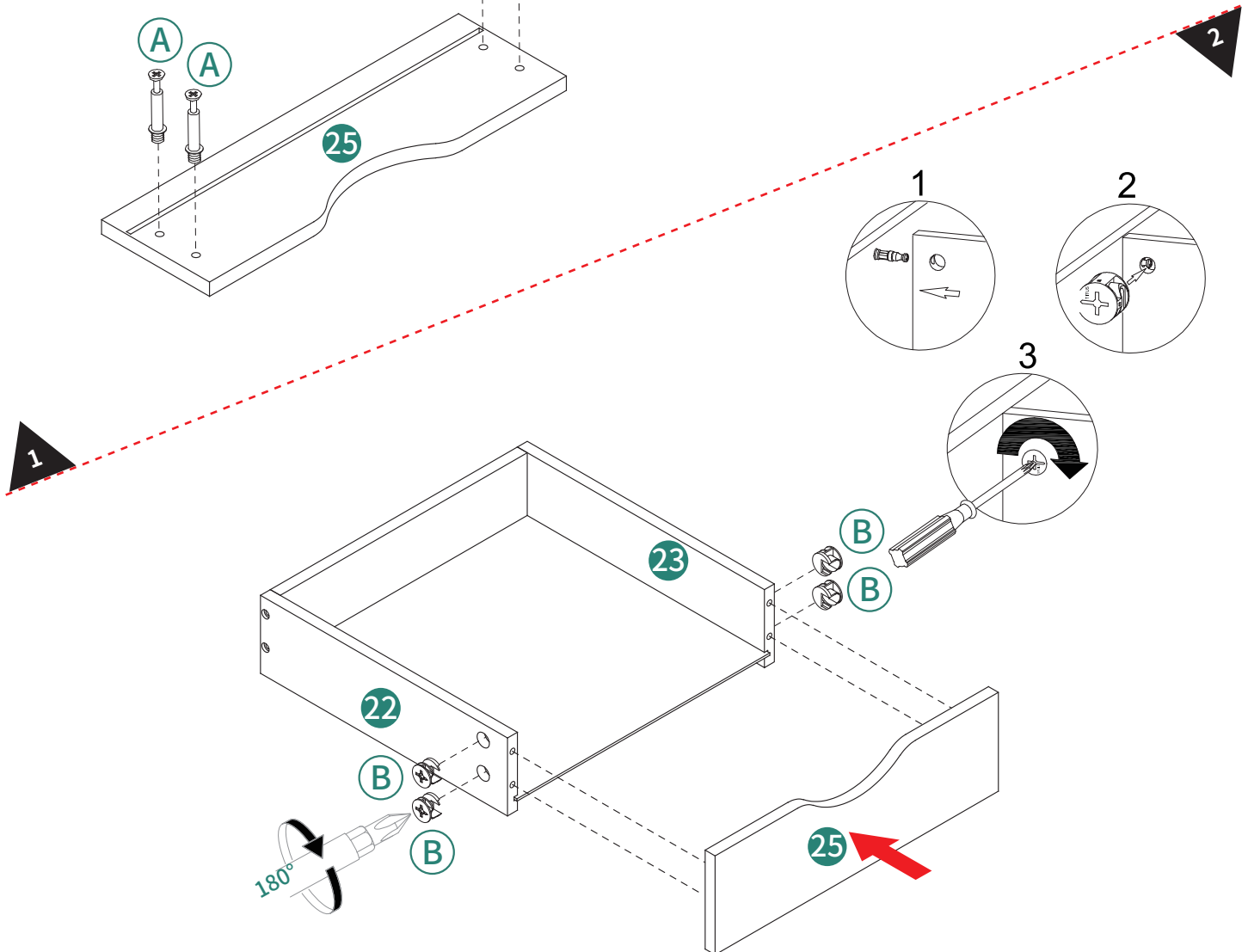
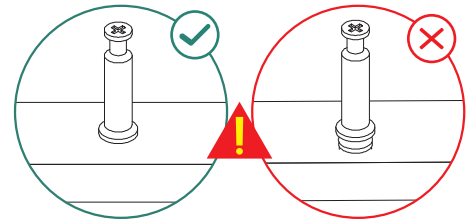

26
X12

ST3.5X12mm



ⓔ48pcs

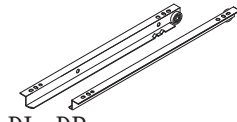

DL DR

ⓐ12pcs

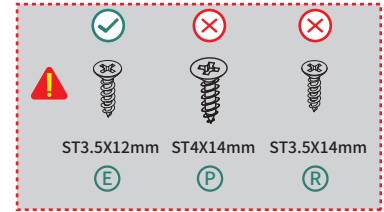

Align the screws with the center of the mounting hole of the guide rail.
Richten Sie die Schrauben mit der Mitte des Montagelochs der Führungsschiene aus.
Alignez les vis avec le centre du trou de montage du rail de guidage.
Allineare le viti con il centro del foro di montaggio della guida.
Alinee los tornillos con el centro del orificio de montaje de la guía.

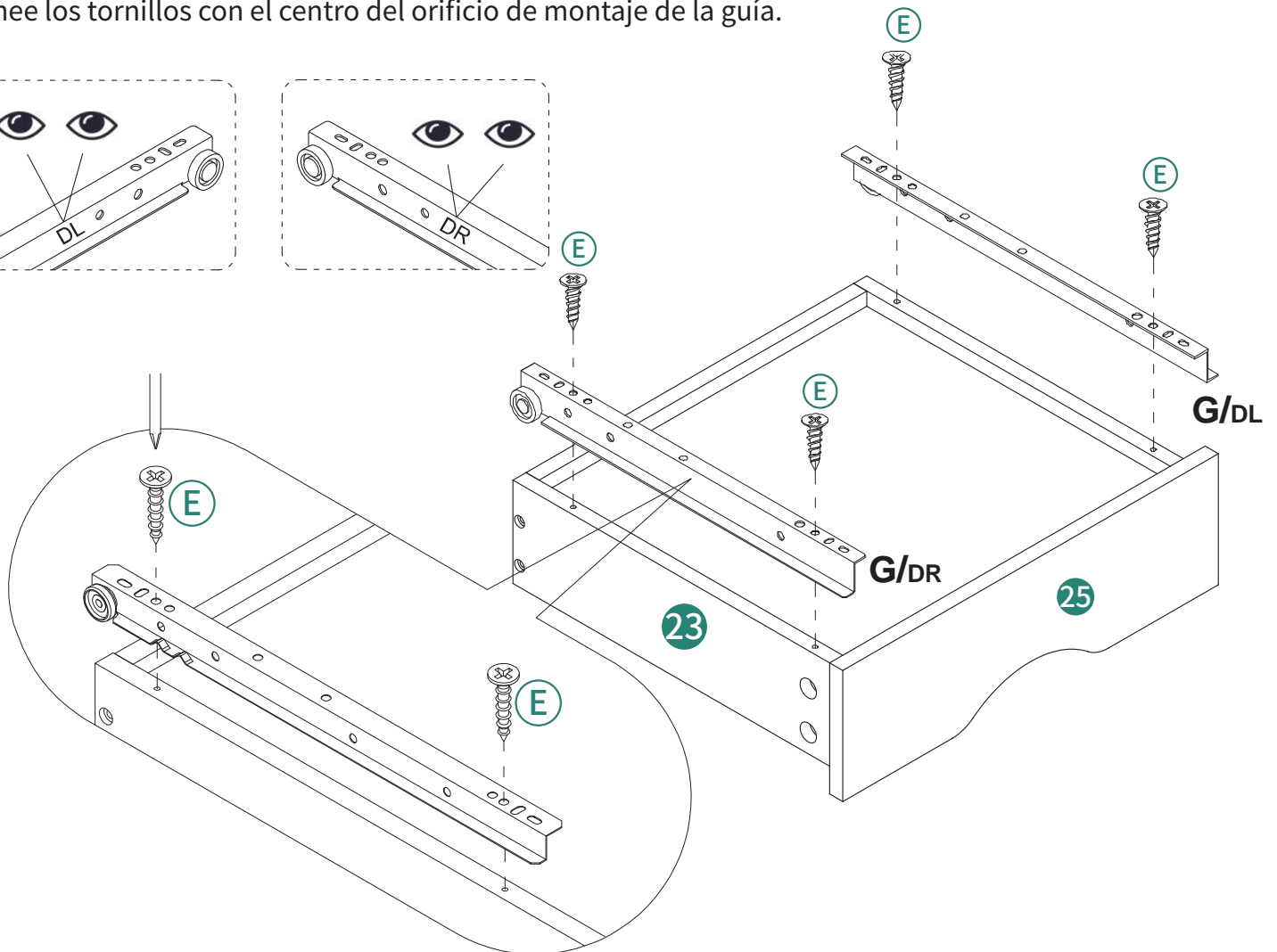
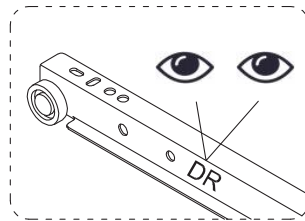
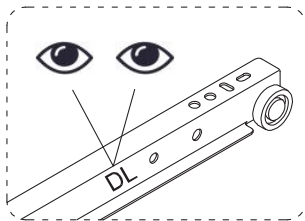

27

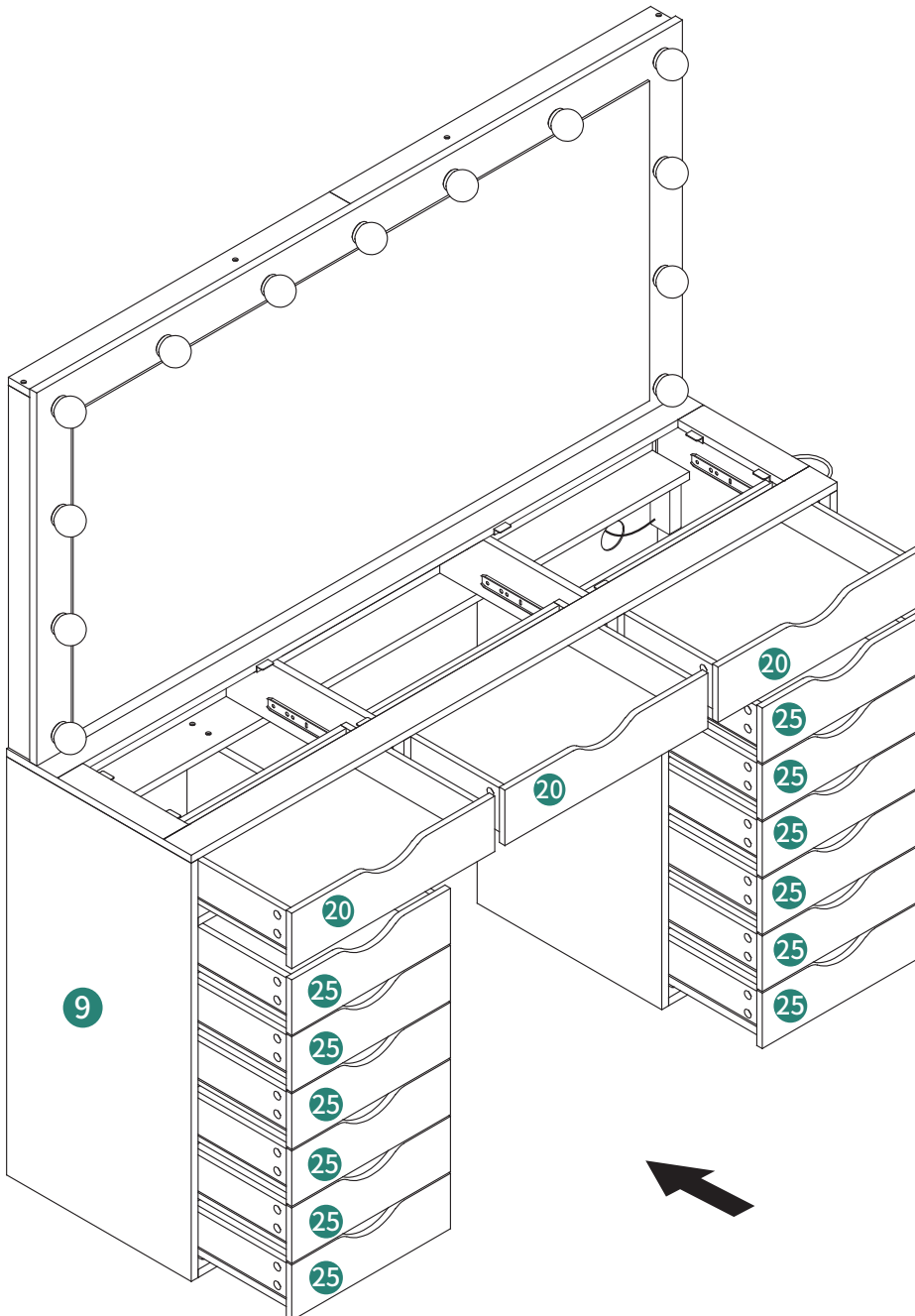

28

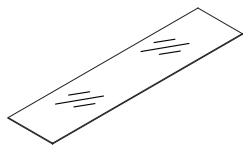

② 1pc

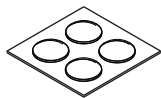

ⓕ 8pcs

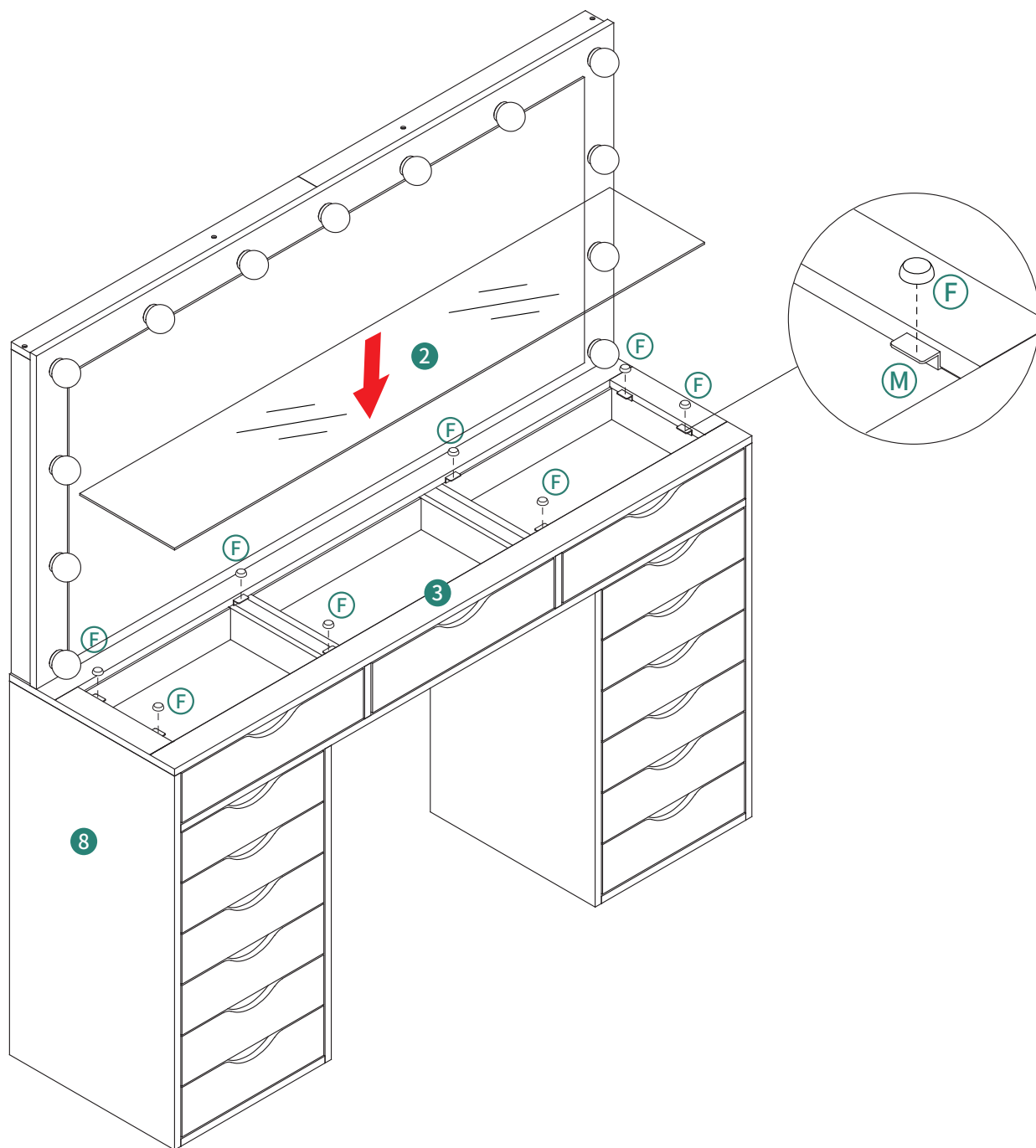

29

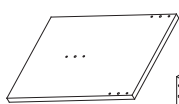

30 2pcs

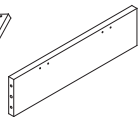

31 2pcs

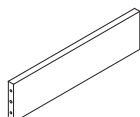

28 1pc

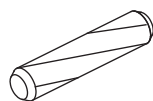

C 6pcs

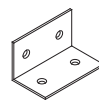

N 4pcs



P 8pcs

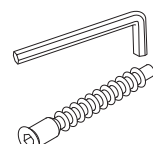

U 12pcs

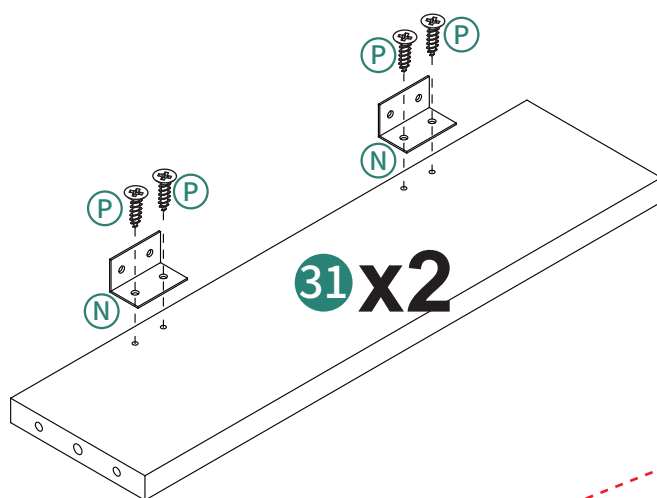

1

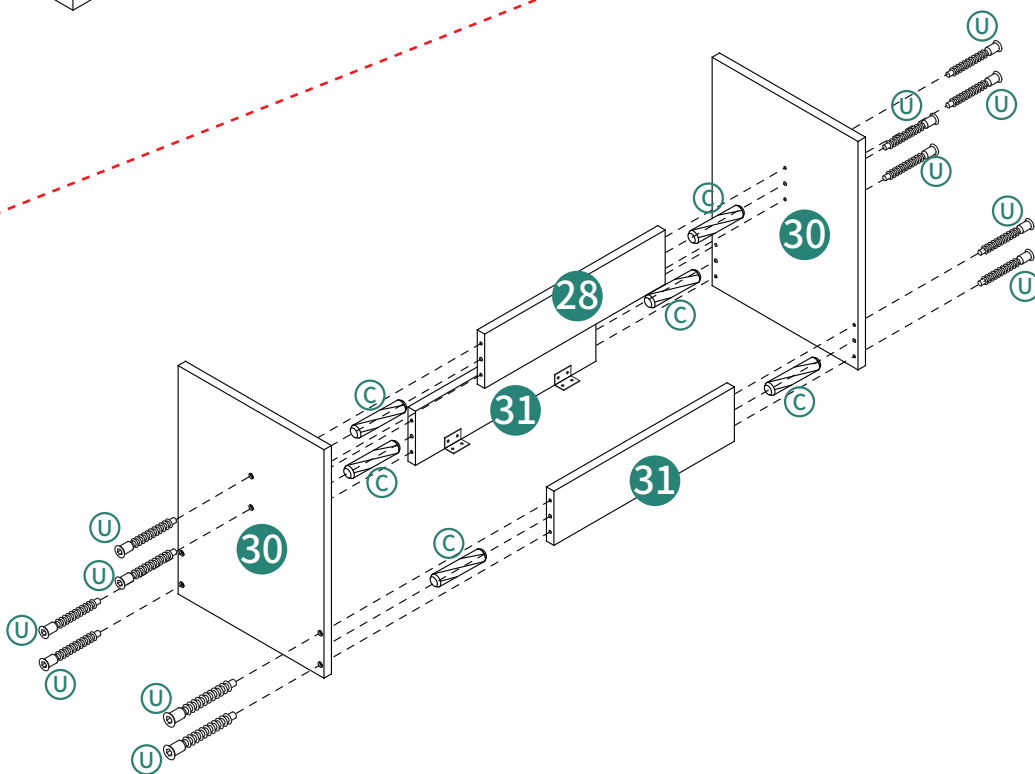
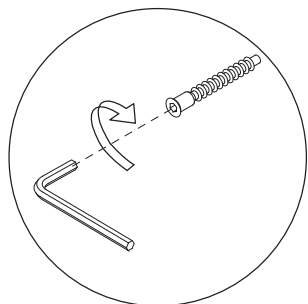

2

30

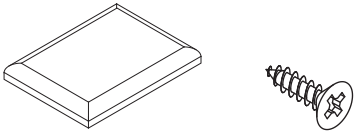

②9 1pc ①P 8pcs

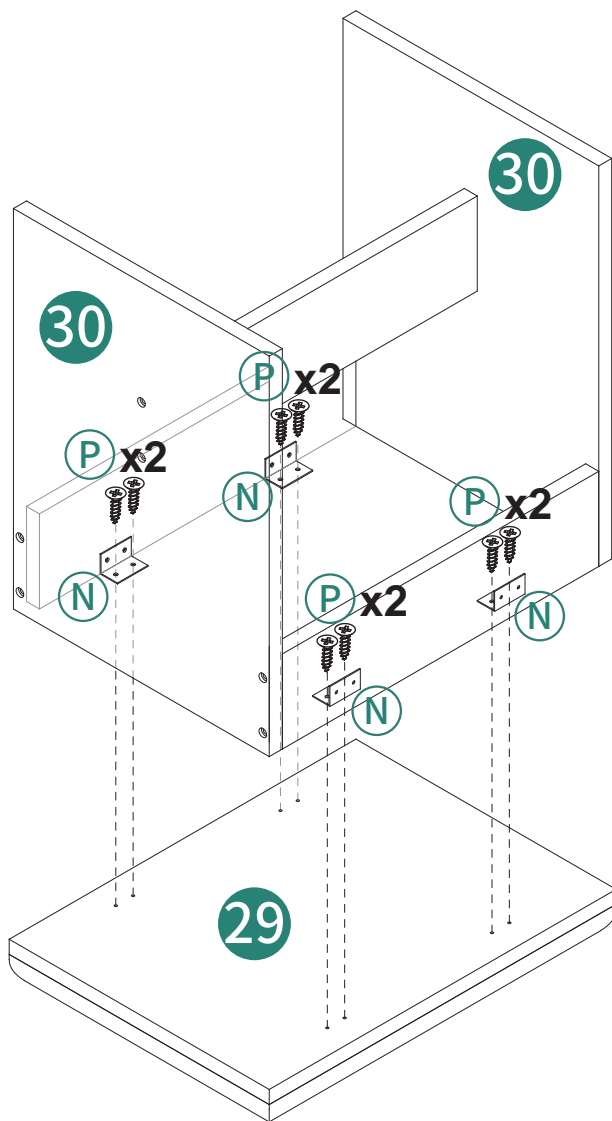

31



⊙16pcs



⊙1pc

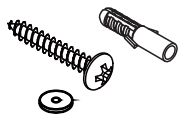

⊙1pc

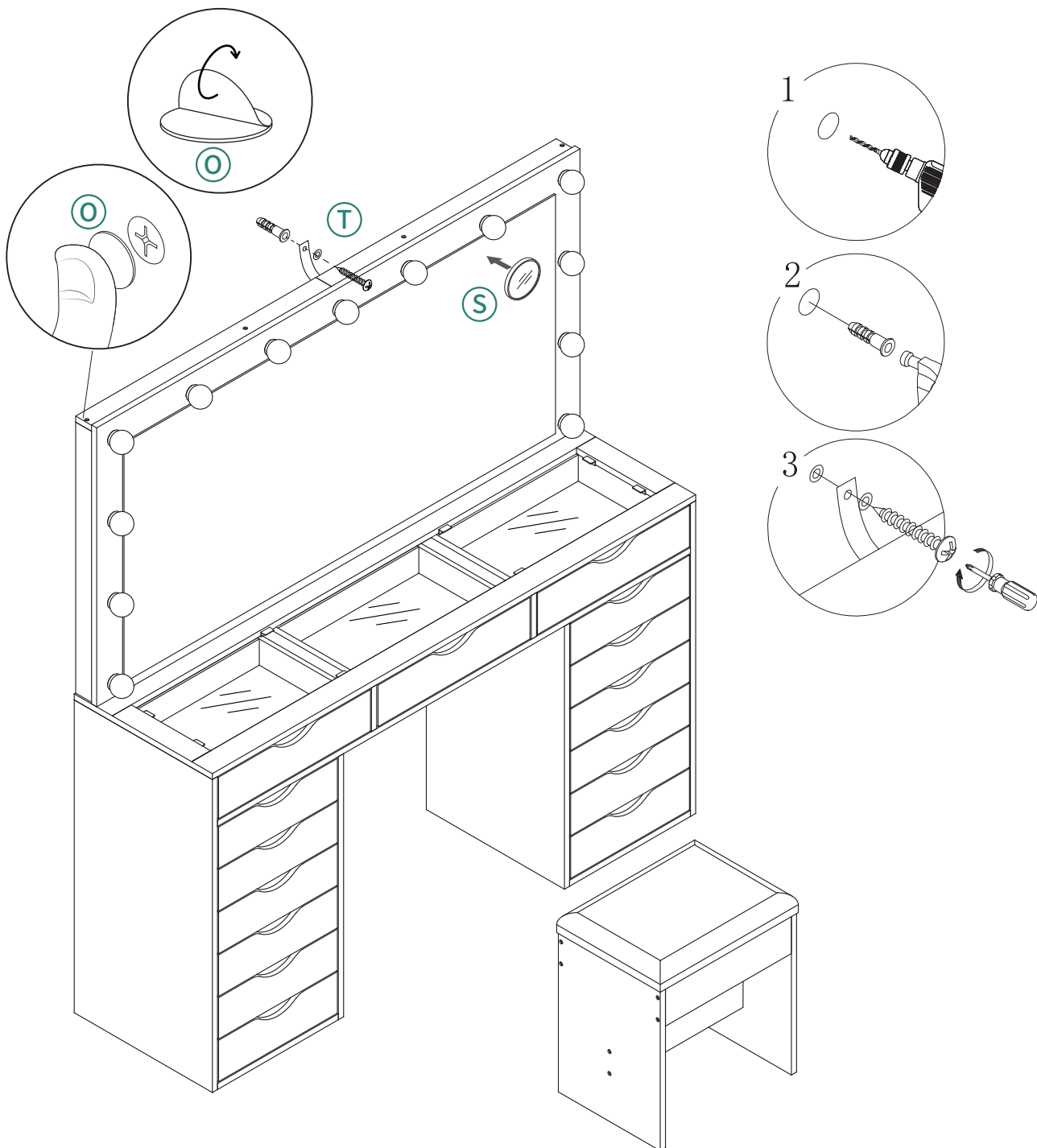

HELP CENTER



Inquiry



Assembly issue



Missing parts



Returns&Refunds

If you encounter any difficulties during assembly, please contact us.support@Yanosaku.com
Wenn Sie während der Montage auf Schwierigkeiten stoßen, kontaktieren Sie uns bitte support@Yanosaku.com

Si vous rencontrez des difficultés lors du montage, veuillez nous contacter support@Yanosaku.com

Se incontri difficoltà durante il montaggio, ti preghiamo di contattarci support@Yanosaku.com
Si encuentras alguna dificultad durante el ensamblaje, por favor contáctanos support@Yanosaku.com

DISCLAIMER

Manufacturer and seller expressly disclaim any and all liability for personal injury, property damage or loss, whether direct, indirect, or incidental, resulting from the incorrect attachment, improper use, inadequate maintenance, unapproved modification, or neglect of this product.

Der Hersteller und Verkäufer lehnen ausdrücklich jegliche Haftung für Personenschäden, Sachschäden oder Verluste ab, egal ob direkt, indirekt oder zufällig, die durch falsche Anbringung, unsachgemäßen Gebrauch, unzureichende Wartung, nicht genehmigte Änderungen oder Vernachlässigung dieses Produkts entstehen.

El fabricante y vendedor renuncian expresamente a toda responsabilidad por lesiones personales, daños materiales o pérdidas, ya sean directos, indirectos o incidentales, derivados de la incorrecta colocación, uso inadecuado, mantenimiento insuficiente, modificación no aprobada o negligencia de este producto.

Il produttore e il venditore declinano espressamente ogni responsabilità per lesioni personali, danni materiali o perdite, dirette, indirette o incidentali, derivanti dall'errato fissaggio, uso improprio, manutenzione inadeguata, modifica non autorizzata o negligenza di questo prodotto.

Le fabricant et le vendeur déclinent expressément toute responsabilité en cas de blessures corporelles, de dommages matériels ou de pertes, qu'ils soient directs, indirects ou accessoires, résultant de la fixation incorrecte, de l'utilisation inappropriée, de l'entretien insuffisant, de la modification non approuvée ou de la négligence de ce produit.