

INSTRUCTIONS

ANWEISUNG

取扱説明書

INSTRUCTION

사용설명서

ISTRUZIONI PER L'INSTALLAZIONE

LIBRO DE INSTRUCCIONES

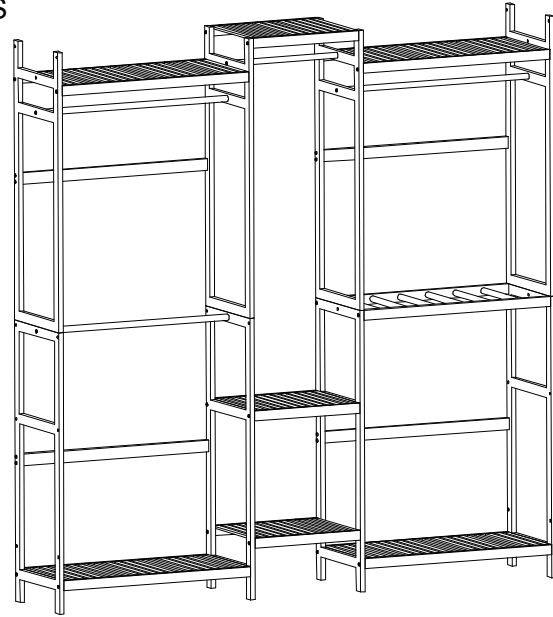

Warning:
 Prevent cargo from tipping over and crushing onto people.
 Vorsichtig, dass Sie nicht von den Waren erdrückt werden.
 Empêcher les marchandises de basculer et de heurter les personnes
 Evitare che le merci si ribaltino e colpiscano le persone
 Evitar que la carga caiga sobre las personas
 荷物の転倒や落下を防ぐよう注意してください。
 제품을 넘어지기를 피하십시오.



FR
 ÉLÉMENTS D'EMBALLAGE
 À SÉPARER ET À DÉPOSER
 DANS LE BAC DE TRI



A*4

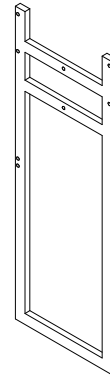

B*4

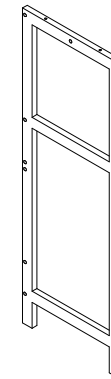

C*3



D*3

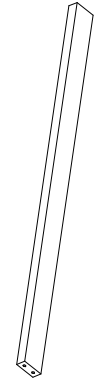

E*3

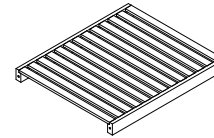

F*4

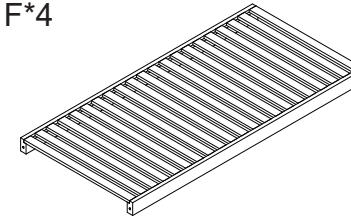

G*1

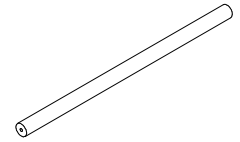

H*1

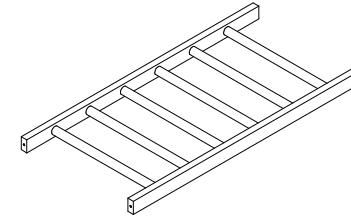

I*64

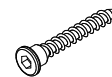

J*2



K*2



L*2

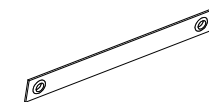

M*1

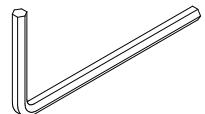

5

I*11 

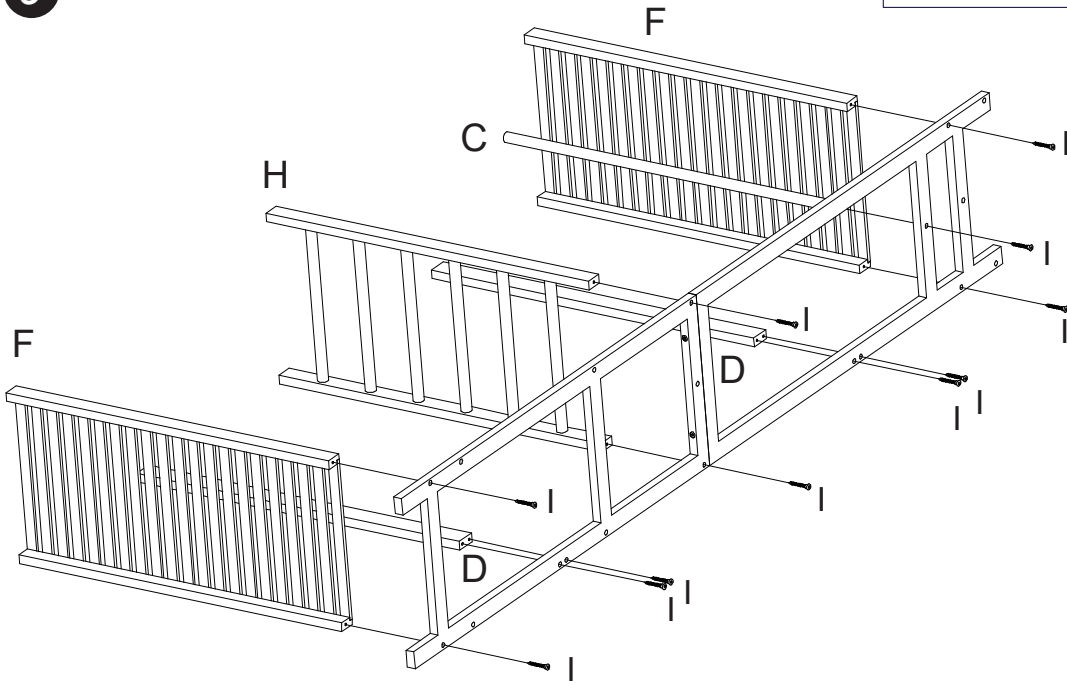

6

I*11 

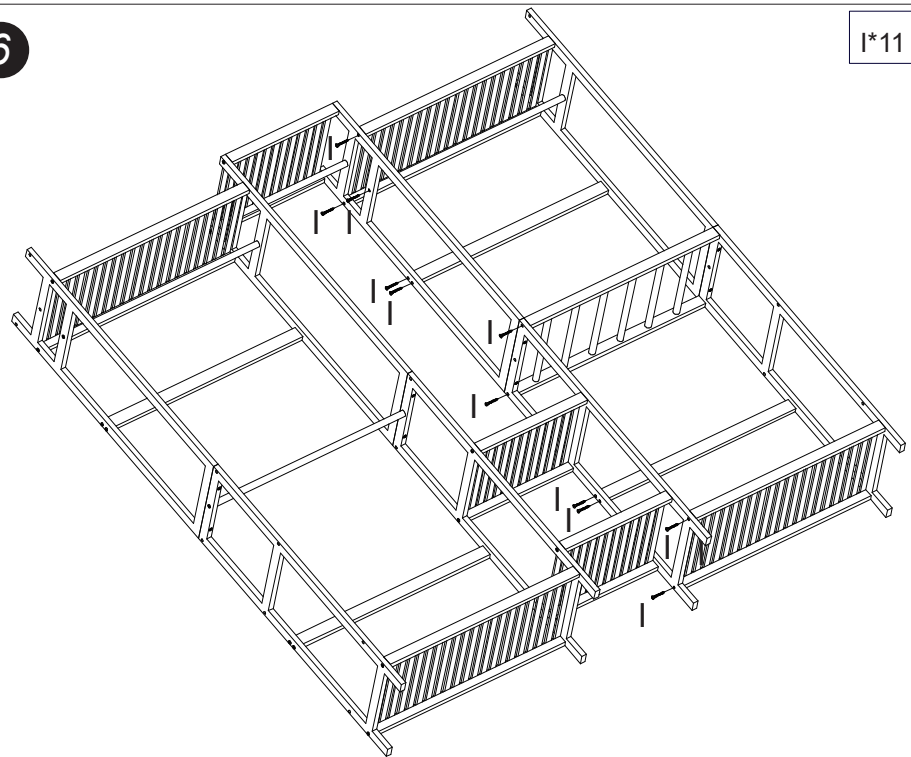

7

J*2 

K*2 

L*2 

