

WARNING

WE RECOMMEND INSTALLATION OF THIS LIGHTING FIXTURE BE DONE BY A LICENSED ELECTRICIAN.

WARNING *** SWITCH OFF THE MAIN ELECTRICAL SUPPLY FROM THE MAIN FUSE BOX/CIRCUIT BREAKER BEFORE INSTALLATION.

INSPECT ITEM CAREFULLY BEFORE ATTEMPTING TO INSTALL. IF THERE IS ANY DAMAGE OR OBVIOUS DEFECT, DO NOT INSTALL. ITEM MAY NOT BE RETURNED ONCE IT HAS BEEN INSTALLED.

CARE AND MAINTENANCE

To clean the outside of the fixture, use a dry or slightly dampened clean cloth (use clean water, never a solvent) to wipe the surface of the fixture.

To clean the inside of the fixture, first disconnect power to the fixture by turning off the circuit breaker or by removing the fuse at the fuse box. Next, use a dry or slightly dampened clean cloth (use clean water, never a solvent) to wipe the interior surface of the fixture.

Do not use any cleaners with chemical solvents or harsh abrasives. Use only a dry soft cloth to dust or wipe carefully.

NOTICE & IMPORTANT SAFETY INSTRUCTIONS

* Please make sure that you have all parts indicated before you begin assembly of this item

* This item should be assembled on a soft surface to prevent scratching the finish during assembly











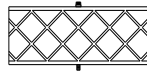
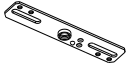

* To reduce the risk of fire, electrical shock or injury to persons or property, please follow the guideline below for safe use and installation

*The external flexible cable or cord of this lamp cannot be replaced

If the cord is damaged, the lamp shall be destroyed

Product Dimensions: 13.25"D X 11"H

Part List and Hardware List

PIECE	DESCRIPTION	PICTURE	QUANTITY	PIECE	DESCRIPTION	PICTURE	QUANTITY
A	mounting screw		2X	I	fixture frame		1X
B	mounting bracket		1X	J	glass		1X
C	machine screw		2X	K	plastic washer		1X
D	wire connector		3X	L	decorative disc		1X
E	screwed ball		2X	M	nut		1X
F	ground screw		1X	N	bulb		2X
G	canopy		1X	O	finial		1X
H	neck		1X				

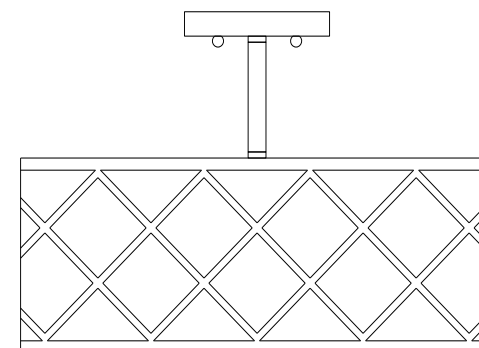

PREPARATION

Before beginning assembly of product, make sure all parts are present. Compare parts with package contents list and hardware contents list. If any part is missing or damaged, do not attempt to assemble the product.

Estimated Assembly Time: 20 minutes.

1. Fix the mounting bracket(B) to the outlet box with machine screw(C).
2. Make wire connections, with wire connectors(D), following the reference chart listed below.

Connect, Hot, Black or Red Outlet Supply Wire to:	Connect, Neutral, White Outlet Supply Wire to:
Black	White
* Parallel Cord (round & smooth)	* Parallel Cord (square & ridged)
Clear, Brown, Gold or Black without Tracer (colored stripes)	Clear, Brown, Gold or Black with Tracer (colored stripes)
Insulated Wire (not green) with copper metal conductor	Insulated Wire (not green) with Silver metal conductor.

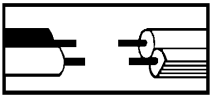

*Note: When parallel wire (SPT I & SPT II) is used. The neutral wire is square shaped and ridged and the hot wire will be round in shape and smooth. (See Illustration on left.)

Grounding Instructions:

- a) For installation in the United States: Wrap ground wire from outlet box around green ground screw(F) on mounting bracket, no less than 2" from wire end. Tighten ground screw. If fixture is supplied with a ground wire, connect to outlet ground wire with a wire connector.
- b) For installation in Canada: If fixture is supplied with ground wire, wrap ground wire around green grounding screw on mounting bracket. Tighten ground screw.

3. Fix the fixture frame(I) to the neck(H).
4. Orient the ceiling canopy(G) so that the mounting screws(A) protruding from the mounting bracket(B) go into the holes in the canopy, then secure it with the provided screwed balls(E).
5. Install bulbs(N). Be sure to use light bulb(N) with wattage no greater than specified on this fixture. Always make sure that electrical current is turned off before changing bulbs.
6. Attach the glass(J) to the fixture frame(I), and fix it in the place with plastic washer(K), decorative disc(L) and nut(M), then attach the finial(O)

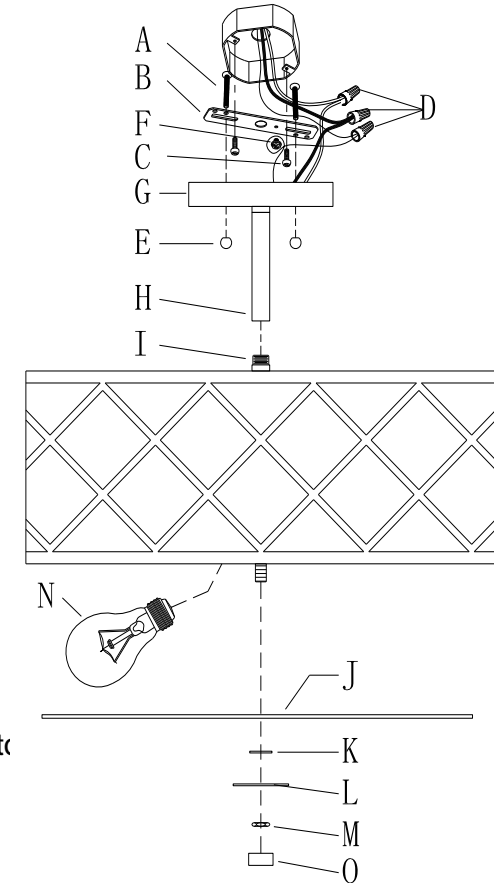

**PLEASE USE TYPE "A" BULB MAX 60-WATT OR CFL BULB MAX 13-WATT OR LED BULB MAX 9 -WATT
THERE ARE 2PCS 9-WATT LED BULB IN THE BOX**

ENJOY YOUR LAMP