

# KF.Y2129 Assembly Manual

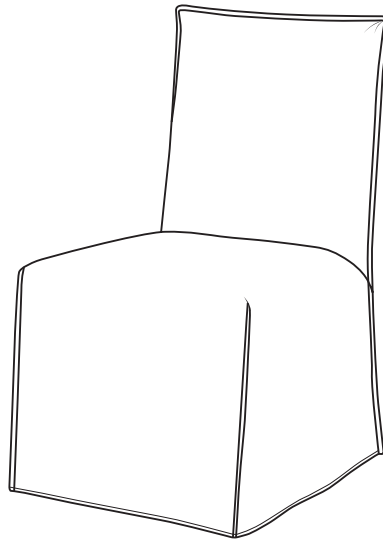



## Dining Chair

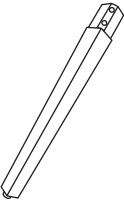
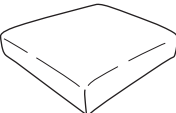
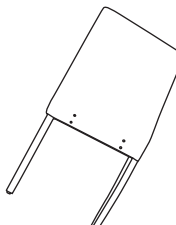
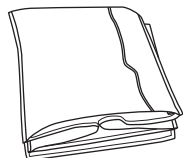

### CAUTION

THIS ASSEMBLY MANUAL CONTAINS IMPORTANT SAFETY INFORMATION.  
PLEASE READ AND KEEP FOR FUTURE REFERENCE.

\*The parts list is for one chair.

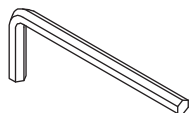
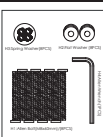
<p><b>Ax2</b></p> 	<p><b>Bx1</b></p> 	<p><b>Cx1</b></p> 	<p><b>Dx1</b></p> 
<p><b>H1x8</b></p> 	<p><b>H2x8</b></p> 	<p><b>H3x8</b></p> 	<p><b>H4x1</b></p> 
			

### ASSEMBLY INSTRUCTIONS

- 1 Please lay the Seat Cushion (B) on soft, clean surface to assemble.
- 2 Open the dust cover and take out the parts package from the bottom of seat.

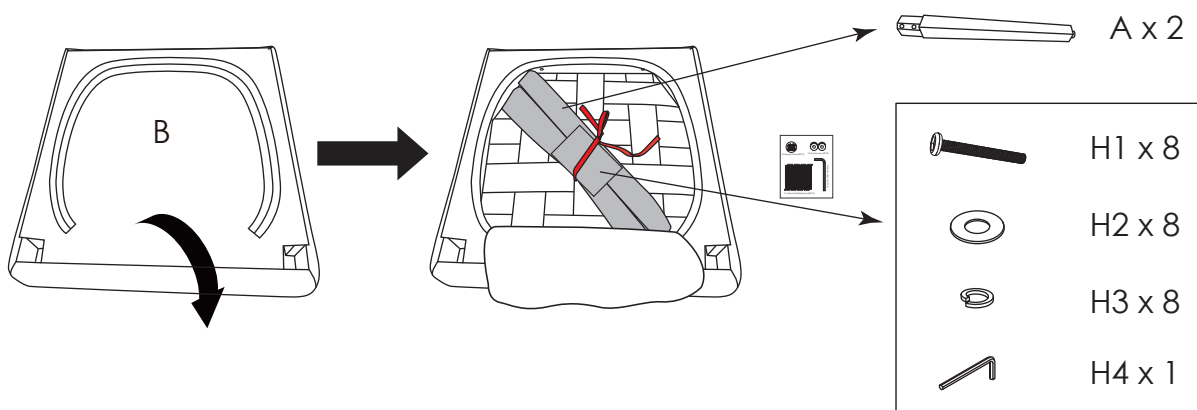

- 3 Attach Seat Cushion (B) to Back Cushion (C) using Bolts (H1x4), Spring Washers (H3x4), Flat Washers (H2x4), and Allen Wrench (H4).  
**Note: Do not fully tighten yet.**

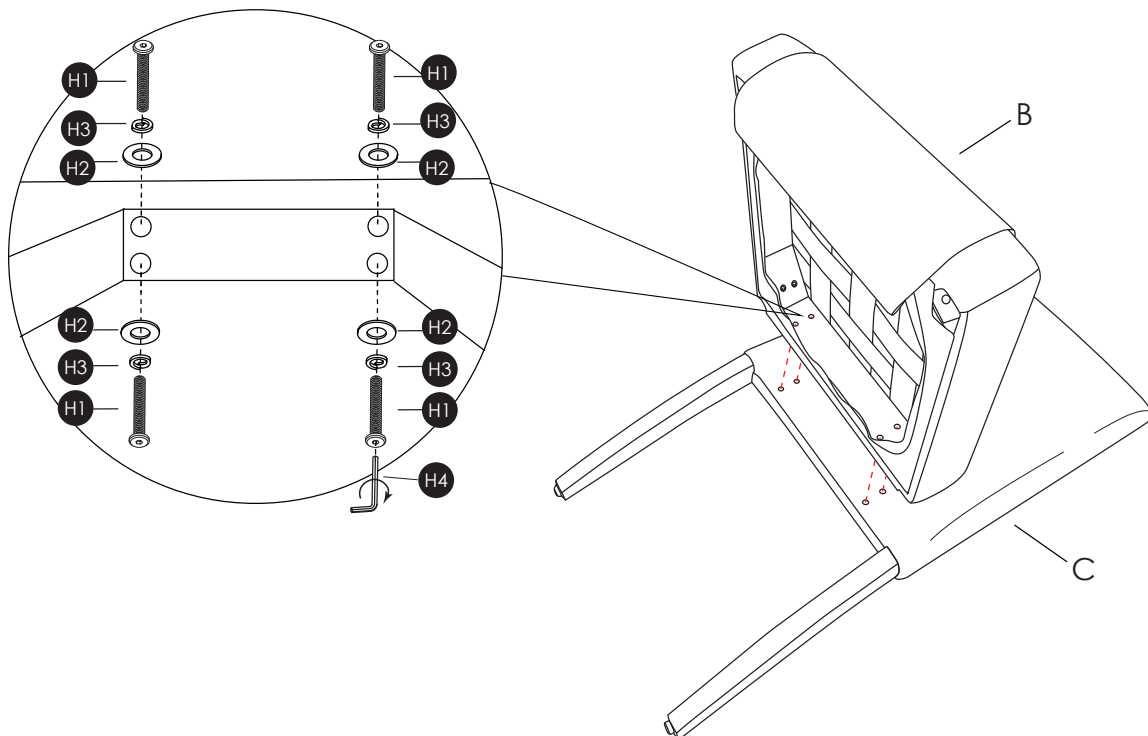

### ASSEMBLY INSTRUCTIONS

- 4** Attach Front legs (A x 2) to Seat Cushion (B) using Bolts (H1 x 4), Spring Washers (H3 x 4), Flat Washers (H2 x 4), and Allen Wrench (H4).  
**Note: Do not fully tighten yet.**

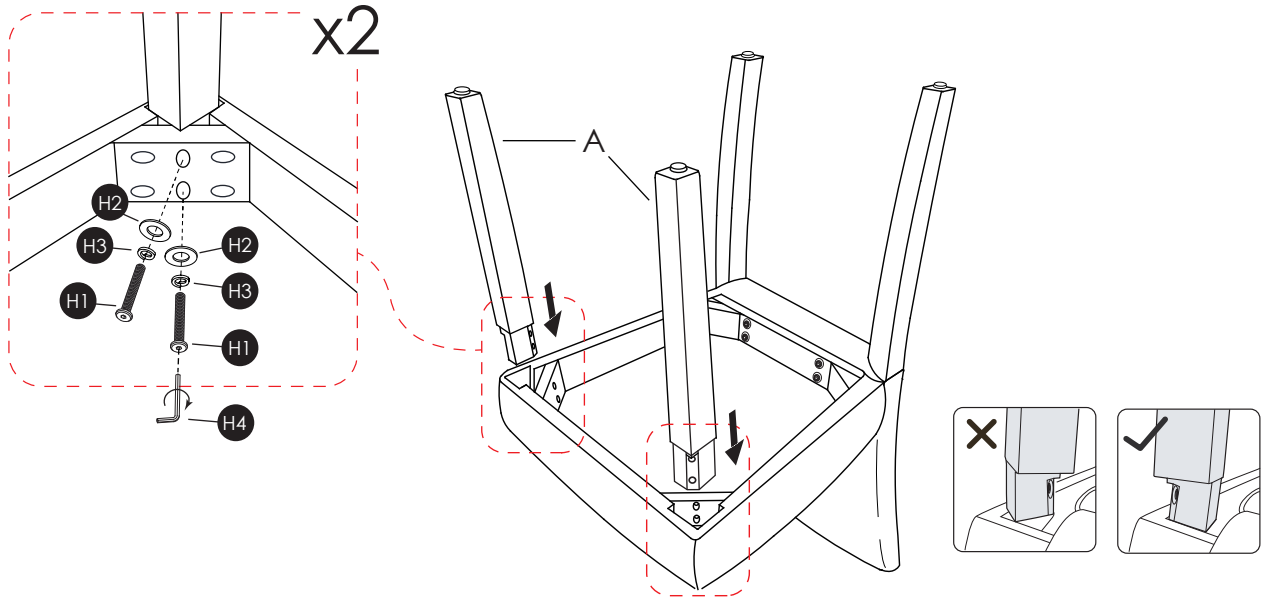

- 5** Flip the chair over and press down on seat over legs to secure in place.

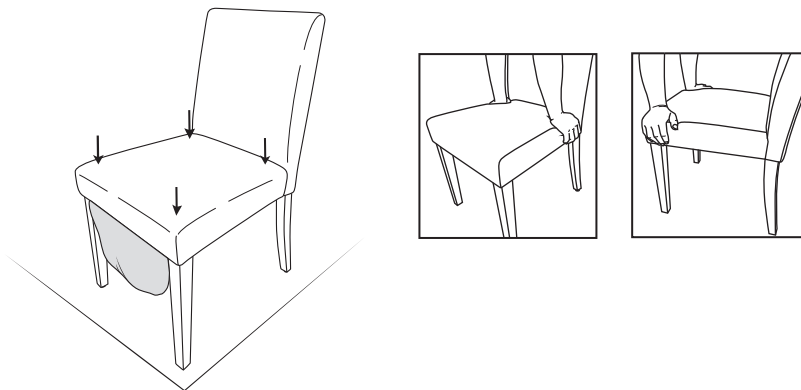

Tighten all bolts and close the dust cover.

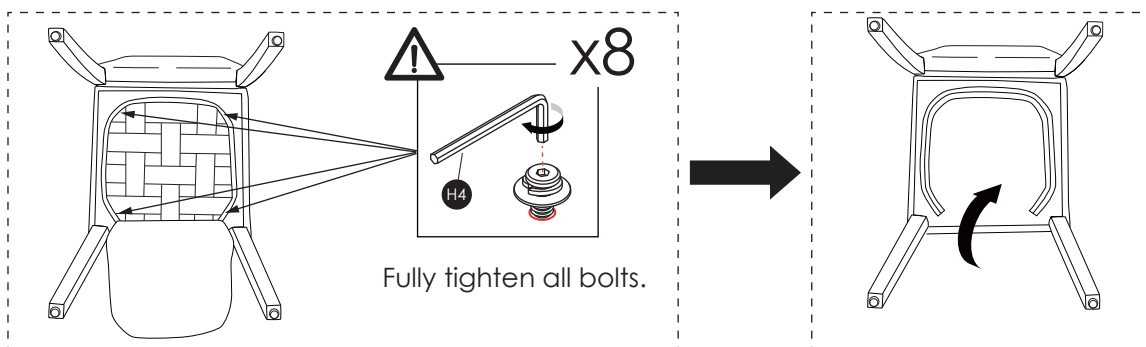

### ASSEMBLY INSTRUCTIONS

- 6** Please double check the balance of the chair, adjust the foot levelers again if needed.

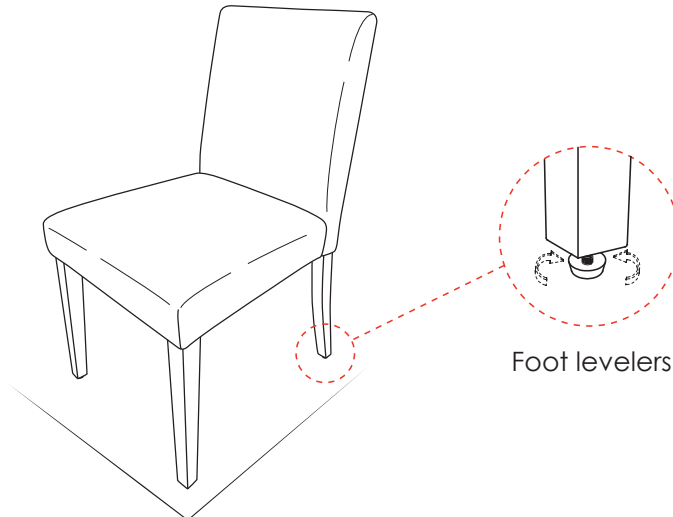

- 7** Put the Cloth Cover (D) on the chair. Assembly completed.

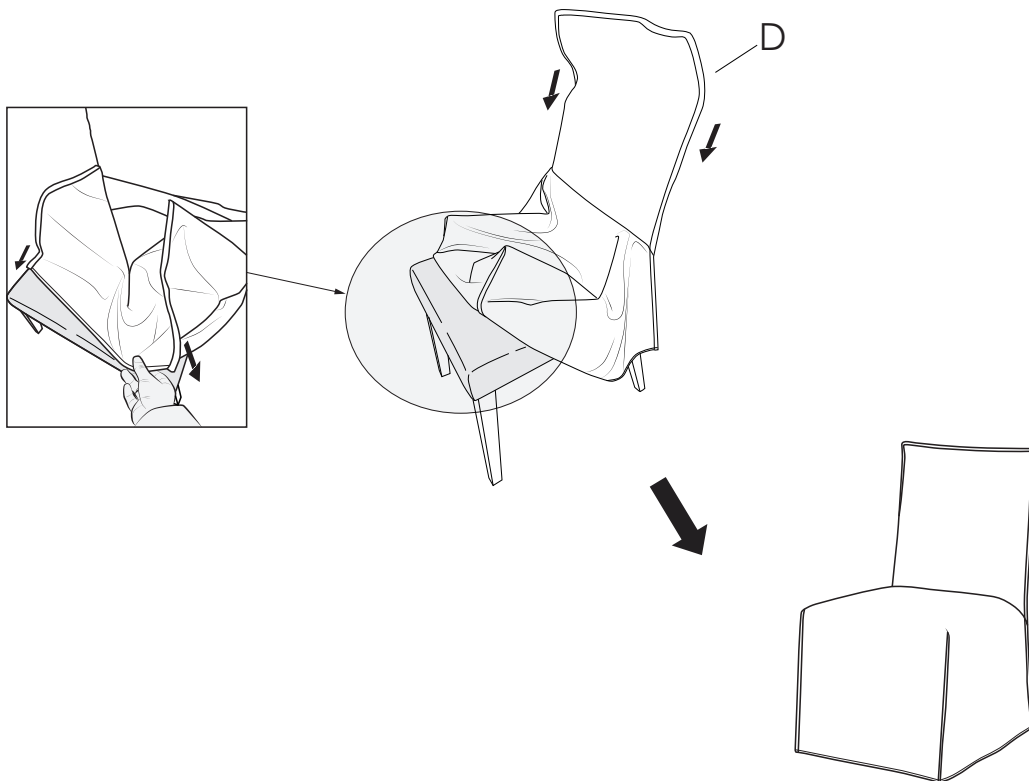

Note: Light steaming may be necessary to remove wrinkles.