

---

# 8063/8063-1

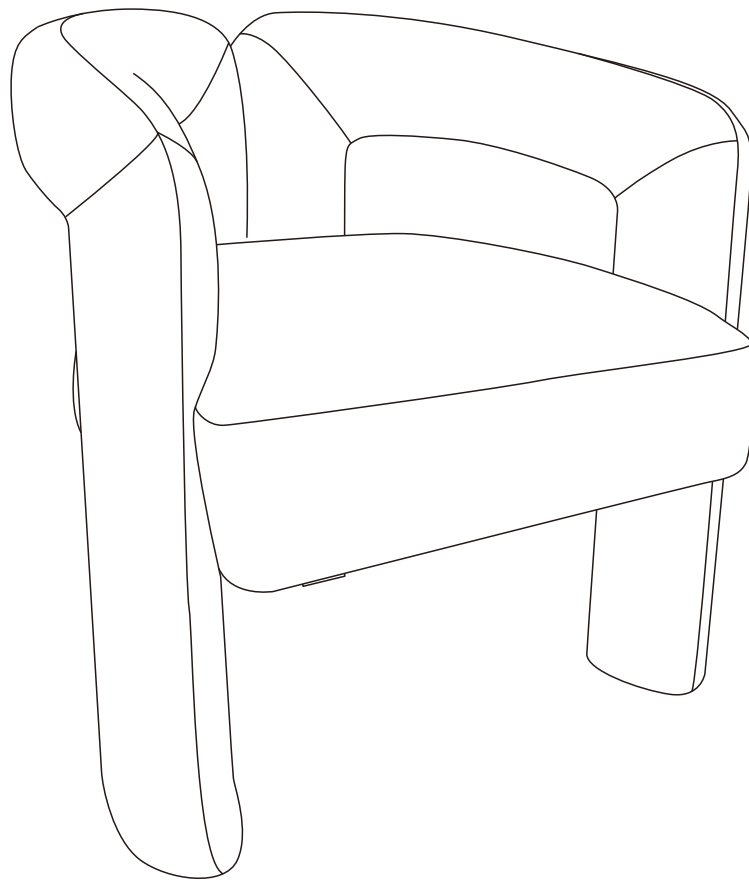

As this item contains many parts, please read the installation instruction carefully before installation . Please use tools properly and carefully. If you have any questions about the product and installation, please contact us.

**[admin@ajyshoming.com](mailto:admin@ajyshoming.com)**

Our professional after-sales team will serve you online all day.

---

# Before You Start

- ✓ Read through each step carefully and follow the proper order
- ✓ Separate and count all your parts and hardware
- ✓ Give yourself enough room for the assembly process

# Helpful Hints

## PEOPLE NEEDED FOR ASSEMBLY: 1-2

---

- Open your item in the area you plan to keep it to avoid excessive heavy lifting.
- Identify, sort and count the parts before attempting assembly.
- Do NOT use harsh chemicals or abrasive cleaners on this item.
- Never push, pull, or drag your furniture.



---

# Part List

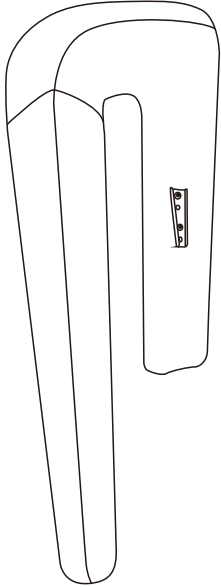

Ⓐ LEFT ARMREST  
QTY:1

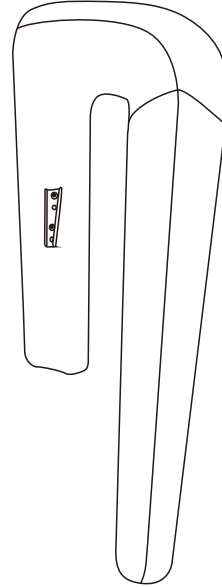

Ⓑ RIGHT ARMREST  
QTY:1

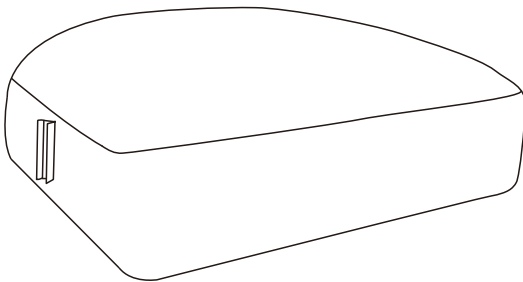

Ⓒ SEAT  
QTY:1

**STEP1** Place the seat(C) upside down on a clean bench.

---

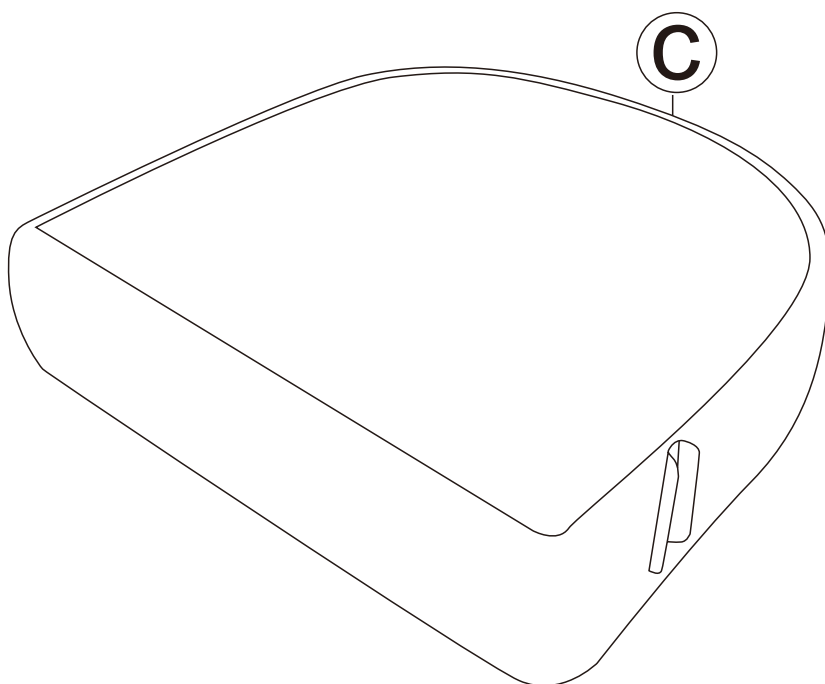

**STEP2** Carefully align male and female metal brackets on both sides then push the left armrest(A) to seat (C) all the way down to secure.

---

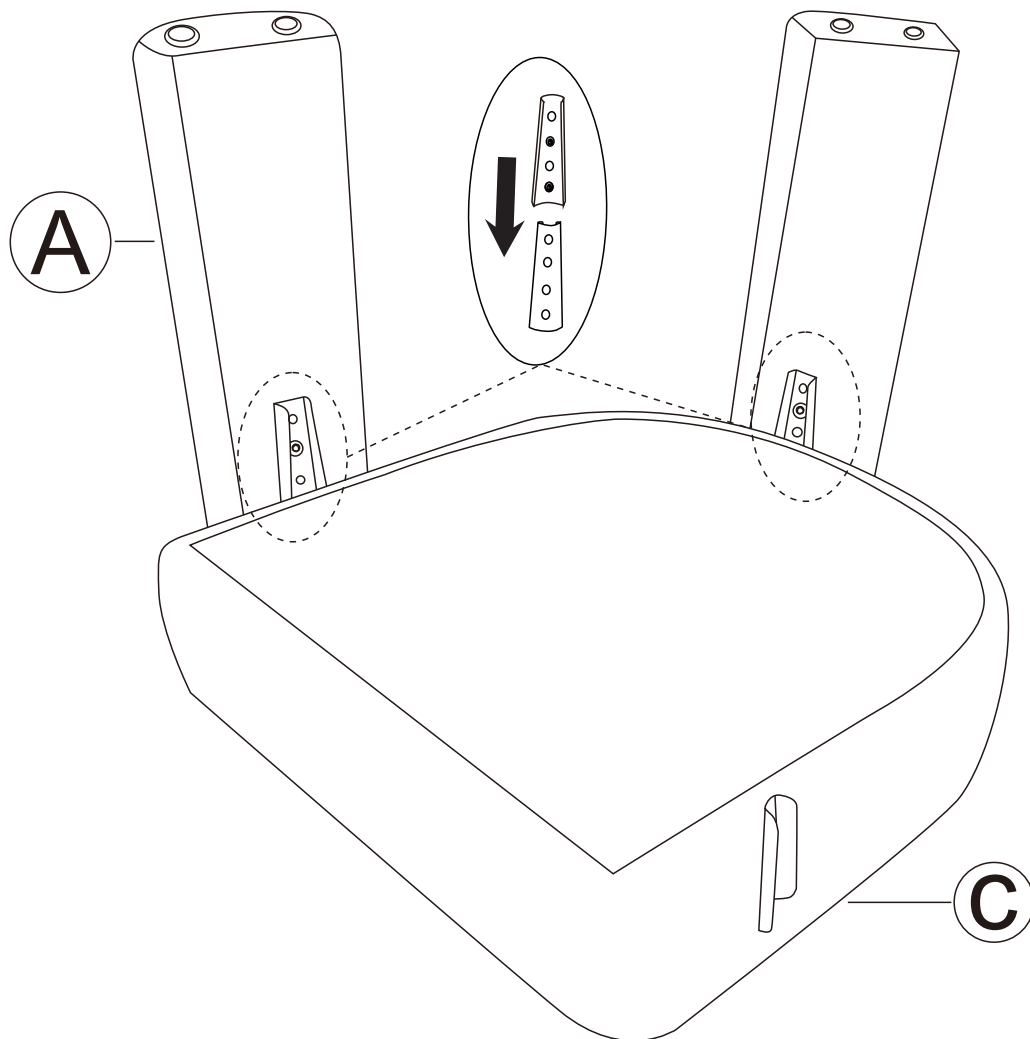

**STEP 3** Carefully align male and female metal brackets on both sides then push the right armrest(B) to seat (C) all the way down to secure.

---

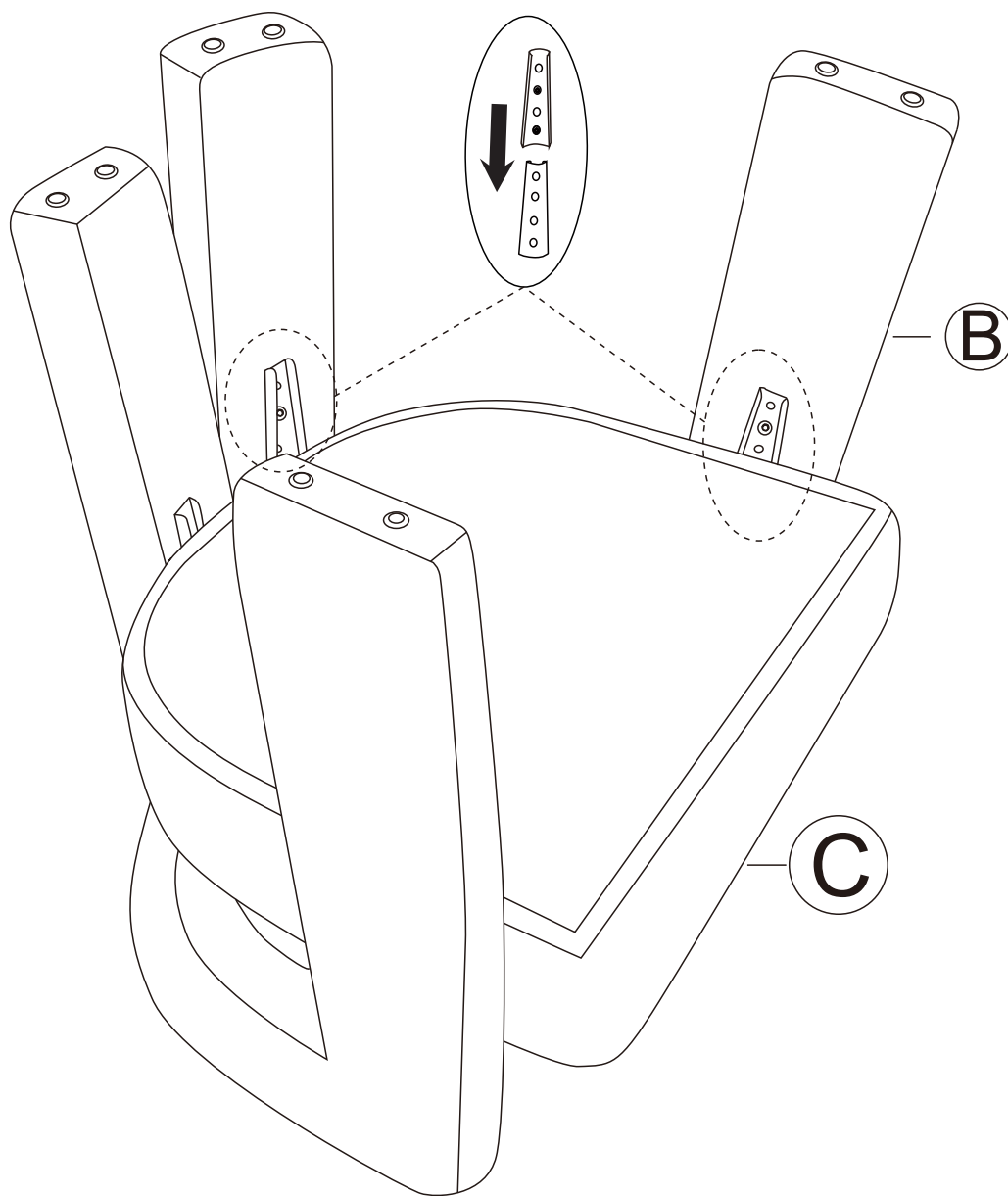

**STEP 4** Turn the assembled seat upright.  
If you find the chair not level, please adjust by rotating the feet pads on the legs.

---

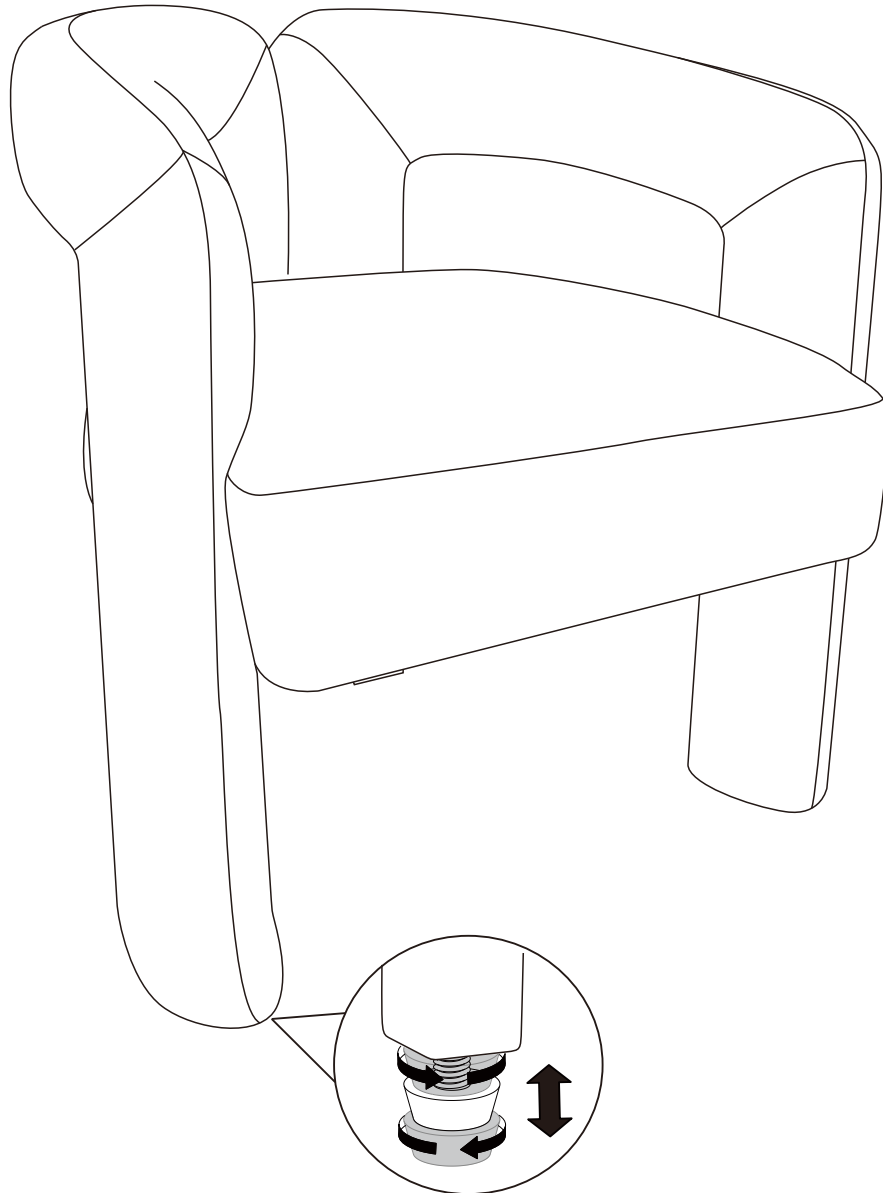

**STEP5** Assembly completed.

---

