

# POUNDEX

## ASSEMBLY INSTRUCTIONS

ITEM NO. F2564/F2565

ROUND DINING TABLE



This page lists all the contents included in the Box. Please take time to identify the hardware as well as the individual components to this product. As you unpack and prepare for assembly, place the contents on a carpeted or padded area to protect them from damage.

### Cleaning & Care

Treat the surface with care, clean with a dry or damp soft cloth.  
Do not use abrasive cleaners. Hardware may be loosen over time.  
Periodically check that all connections are tight.  
A Phillips screwdriver is necessary for assembly.

## GENERAL INFORMATION, TIPS & TRICKS

1. Please read the assembly instructions prior to assembling this product.
2. To avoid damages, assemble this product on a non-abrasive surface such as a carpet.
3. Make sure all bolts and nuts are tightly fastened before the product is used.
4. Not for commercial use.
5. Care: Wipe with a damp cloth. Use furniture polish or lemon oil on the wood as needed. Avoid prolonged exposure to moisture.

---

Please make sure you have all parts before beginning assembly. Please wait until all steps are completed before tightening bolts. We recommend two people to assemble.

---

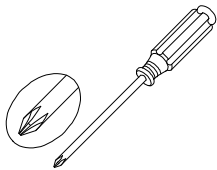



A Phillips screwdriver is necessary for assembly.





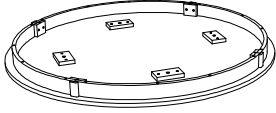

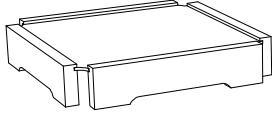
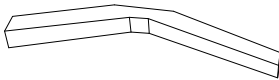
---

Do not put hot pots or objects which are more than 80 degrees Fahrenheit directly on the table.

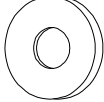
# TABLE PART LIST

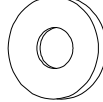
A. Table Top	B. Connector Panels	C. Middle Shelf	D. Table Legs
			
QTY: 1 PC	QTY: 4 PCS	QTY: 1 PC	QTY: 4 PCS

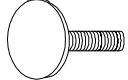
# TABLE HARDWARE LIST

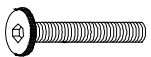
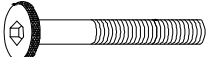
1. SPRING WASHERS	2. FLAT WASHERS	3. SPRING WASHERS	4. FLAT WASHERS
			
SIZE: 5/16" DIA	SIZE: 5/16" DIA	SIZE: 1/4" DIA	SIZE: 1/4" DIA
QTY: 8 PCS	QTY: 8 PCS	QTY: 8 PCS	QTY: 8 PCS
5. LONG BOLTS	6. LEVELERS	7. ALLEN KEY	8. SHORT BOLTS
			
SIZE: 5/16" x 1 1/4"	SIZE: 1/4" DIA	SIZE: 1/4" DIA	SIZE: 1/4" x 1"
QTY: 4 PCS	QTY: 4 PCS	QTY: 1 PC	QTY: 8 PCS
9. SHORT BOLTS			
			
SIZE: 5/16" x 2 3/8"			
QTY: 8 PCS			

# TABLE ASSEMBLY INSTRUCTIONS

## STEP 1

Attach the Connector Panels (B) to the Table Legs (D) by using Long Bolts (5). Tighten by using Allen Key (7).

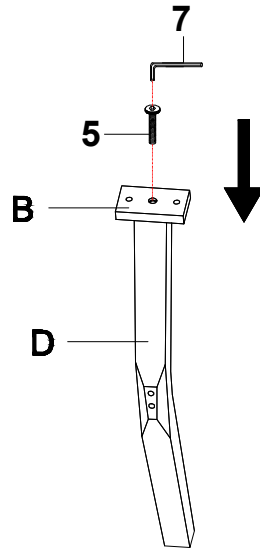

## STEP 2

Attach the Table Legs (D) to the Table Top (A) by using Short Bolts (8), Spring Washers (3), and Flat Washers (4) with Allen Key(7). Do not tighten all bolts at this step.

Attach Middle Shelf (C) to the Table Legs (D) by using Short Bolts (9), Spring Washers (1), and Flat Washers (2) with Allen Key (7). Do not tighten all bolts at this step.

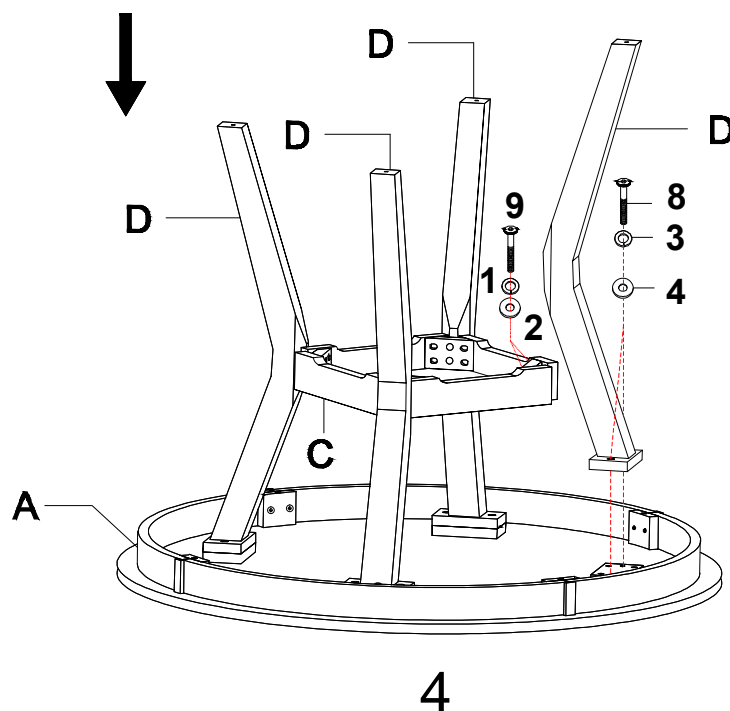

# TABLE ASSEMBLY INSTRUCTIONS

## STEP 3

Attach the Levelers (6) to the base of the Table Legs (D) in clockwise direction.

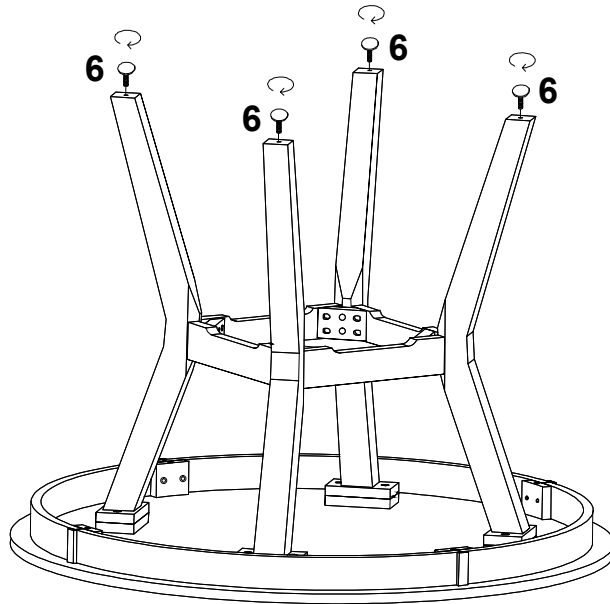

## STEP 4

Turn the table to the upright position carefully. Make sure the table is level, and then securely tighten all bolts at this stage. Assembly is now completed.

