

User's Manual



**Please Do Not Return the Product to the Store.
Contact us with any questions.**

INSTALLATION INSTRUCTIONS

Installation Manual



IAPMO RESEARCH AND TESTING, INC.
5001 East Philadelphia Street, Ontario, California 91761-2816 - USA - 909-472-4100 - 909-472-4244 - www.iapmort.org

CERTIFICATE OF LISTING

IAPMO Research and Testing, Inc. is a product certification body which tests and inspects samples taken from the supplier's stock or from the market or a combination of both to verify compliance to the requirements of applicable codes and standards. This activity is coupled with periodic surveillance of the supplier's factory and manufacturing as well as the assessment of the supplier's Quality Assurance System. This listing is subject to the conditions set forth in the regulations which apply and is not to be construed as any recommendation, assurance or guarantee by IAPMO Research and Testing, Inc. of the product or its performance.

This certificate is not evidence of current listing. To verify listing status, visit the IAPMO RAT Product Listing Directory at pid.iapmo.org

Effective Date: December 2019 -Rev. 2/24/2020- Void After: December 2024
Product: Flexible Water Connectors File No. 5311

Issued To: Fankui Group Inc.
Mechanical & Electrical
Industrial Zone,
Yuhuan County,
Yuhuan 317600, ZHEJIANG
China

Identification: Products shall be marked with manufacturer's name or trademark, a statement "For use with water in accessible locations only." The products shall also bear the cUPC® certification mark. Markings shall be by means of either a permanent mark on the product, a label on the product or a tag attached to the product.

Characteristics: Flexible water connectors manufactured in various sizes, lengths and metal end fittings for hot or cold water applications that consist of an inner tube, which may or may not have an outer braided cover. Connectors are to be installed for use in accessible locations only. To be installed in accordance with the manufacturer's instruction, and the latest edition of the Uniform Plumbing Code and National Plumbing Code of Canada.

Products listed on this certificate have been tested by an IAPMO RAT recognized laboratory. This recognition has been granted based upon the

Tom Collins Chairman, Product Certification Committee *Ran Chang* CEO, The IAPMO Group

This listing period is based upon the last date of the month indicated on the Effective Date and Void After Date shown above. Any change in material manufacturing process, marking or design without having first obtained the approval of the Product Certification Committee, or any evidence of non-compliance with applicable codes and standards or of false markings, may be deemed sufficient cause for revocation of this listing. Production of or reference to this form for advertising purposes may be made only by specific written permission of IAPMO Research and Testing, Inc. Any alteration of this certificate could be grounds for revocation of the listing. This document shall be reproduced in its entirety.



IAPMO RESEARCH AND TESTING, INC.
5001 East Philadelphia Street, Ontario, California 91761-2816 - USA - 909-472-4100 - 909-472-4244 - www.iapmort.org

CERTIFICATE OF LISTING

IAPMO Research and Testing, Inc. is a product certification body which tests and inspects samples taken from the supplier's stock or from the market or a combination of both to verify compliance to the requirements of applicable codes and standards. This activity is coupled with periodic surveillance of the supplier's factory and manufacturing as well as the assessment of the supplier's Quality Assurance System. This listing is subject to the conditions set forth in the regulations which apply and is not to be construed as any recommendation, assurance or guarantee by IAPMO Research and Testing, Inc. of the product or its performance.

This certificate is not evidence of current listing. To verify listing status, visit the IAPMO RAT Product Listing Directory at pid.iapmo.org

Effective Date: November 2019 Void After: November 2024
Product: Plumbing Fixture Fittings File No. 10633

Issued To: Aqua Gallery Co., Ltd
13th-15th AIO Block
International Ceramic
Sanitary City, 528000
Foshan,
China

Identification: Plumbing supply fittings complying with this Standard shall be marked with the manufacturer's recognized name, trademark, or other mark or, in the case of private labeling, the name, trademark or other mark of the customer for whom the fitting was manufactured. The marking shall be accomplished by use of a permanent mark or by placing a permanent label on the product. Markings on plumbing supply fittings shall be visible after installation.

Single-handle, single-control, and automatic compensating mixing bath and shower valves shall have identifiable temperature control settings in which the settings are indicated by words "cold", "warm", "hot", etc.), by numbers, or graphically.

Packages shall be marked with the manufacturer's name, trademark, or other mark as well as the model number or, in the case of private

Tom Collins Chairman, Product Certification Committee *Ran Chang* CEO, The IAPMO Group

This listing period is based upon the last date of the month indicated on the Effective Date and Void After Date shown above. Any change in material manufacturing process, marking or design without having first obtained the approval of the Product Certification Committee, or any evidence of non-compliance with applicable codes and standards or of false markings, may be deemed sufficient cause for revocation of this listing. Production of or reference to this form for advertising purposes may be made only by specific written permission of IAPMO Research and Testing, Inc. Any alteration of this certificate could be grounds for revocation of the listing. This document shall be reproduced in its entirety.



IAPMO RESEARCH AND TESTING, INC.
5001 East Philadelphia Street, Ontario, California 91761-2816 - USA - 909-472-4100 - 909-472-4244 - www.iapmort.org

CERTIFICATE OF LISTING

IAPMO Research and Testing, Inc. is a product certification body which tests and inspects samples taken from the supplier's stock or from the market or a combination of both to verify compliance to the requirements of applicable codes and standards. This activity is coupled with periodic surveillance of the supplier's factory and manufacturing as well as the assessment of the supplier's Quality Assurance System. This listing is subject to the conditions set forth in the regulations which apply and is not to be construed as any recommendation, assurance or guarantee by IAPMO Research and Testing, Inc. of the product or its performance.

This certificate is not evidence of current listing. To verify listing status, visit the IAPMO RAT Product Listing Directory at pid.iapmo.org

Effective Date: March 2019 Void After: March 2024
Product: Plumbing Fixture Fittings - Components File No. MC-9703

Issued To: Ningbo Manhai Cartridge Technology Co., Ltd.
Xiaohen Zone, Chunyu
Fenghua, ZHEJIANG 315518
China

Identification: Each fitting component shall bear permanent legible markings to identify the manufacturer. This marking shall be the trade name, trademark, or other mark known to identify the manufacturer. The product shall also bear all other markings required by the standard. The marking shall be applied so as to be visible after installation. The product or packaging shall also bear the cUPC® certification mark along with the term "COMPONENT" above.

Characteristics: Plumbing fixture fitting components to be installed in accordance with the manufacturer's instructions and the requirements of the latest edition of the Uniform Plumbing Code.

Products listed on this certificate have been tested by an IAPMO RAT recognized laboratory. This recognition has been granted based upon the laboratory's compliance to the applicable requirements of ISO/IEC 17025.

Products are in compliance with the following code(s):
Uniform Plumbing Code (UPC®)

Tom Collins Chairman, Product Certification Committee *Ran Chang* CEO, The IAPMO Group

This listing period is based upon the last date of the month indicated on the Effective Date and Void After Date shown above. Any change in material manufacturing process, marking or design without having first obtained the approval of the Product Certification Committee, or any evidence of non-compliance with applicable codes and standards or of false markings, may be deemed sufficient cause for revocation of this listing. Production of or reference to this form for advertising purposes may be made only by specific written permission of IAPMO Research and Testing, Inc. Any alteration of this certificate could be grounds for revocation of the listing. This document shall be reproduced in its entirety.



Installation precautions

- a) After opening the product package, please check the completeness of the parts listed in the "Standard Parts List". If there are any defects, please contact your local dealer immediately.
- b) The installation size of the faucet should match the installation size of the embedded water inlet pipe.
- c) The main part of the faucet has been tested and debugged by the factory. Do not disassemble it by yourself to avoid affecting the performance.
- d) The faucet must be connected with the hot and cold water pipes. Pay special attention to the hot water on the left and cold water on the right.
- e) Before installing the faucet, be sure to remove the impurities and sludge in the buried pipeline first, so as not to block and affect the water output function.
- f) After installation, please turn on the water source switch, and then check whether the links are tightly connected to ensure that there is no leakage.
- g) The internal structure of the faucet contains non-high temperature resistant components such as silica gel. Do not use it in high temperature environments. Do not use it for a long time at a water temperature exceeding 90 ° C.
- h) It is recommended to use water pressure: 0.05Mpa-0.75Mpa.
- i) Do not bend the hose excessively. Make sure that the hose is not deformed after installation.

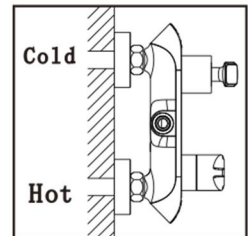
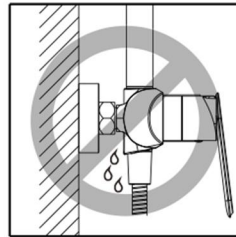
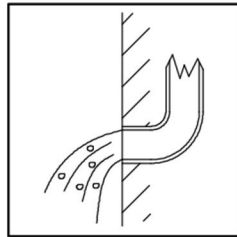
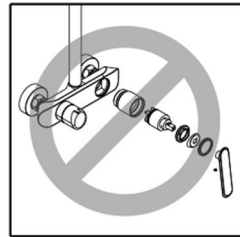

Recommend Tools And Materials

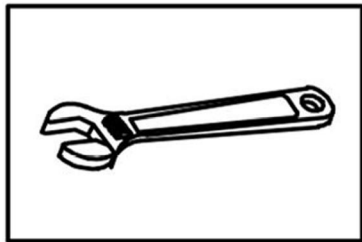

Adjustable Wrench

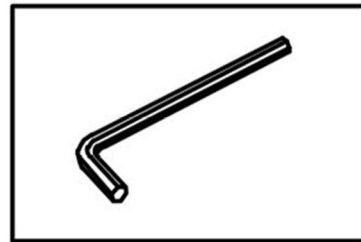

Hexagon wrench

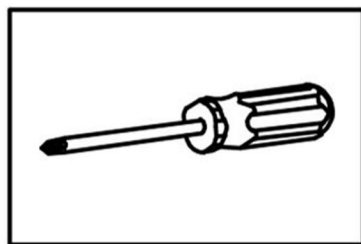

Philips Screwdriver

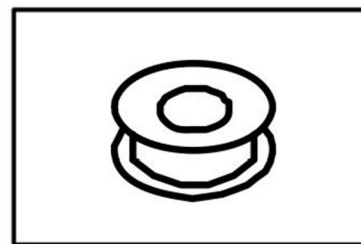

Pipe Tape

Product size

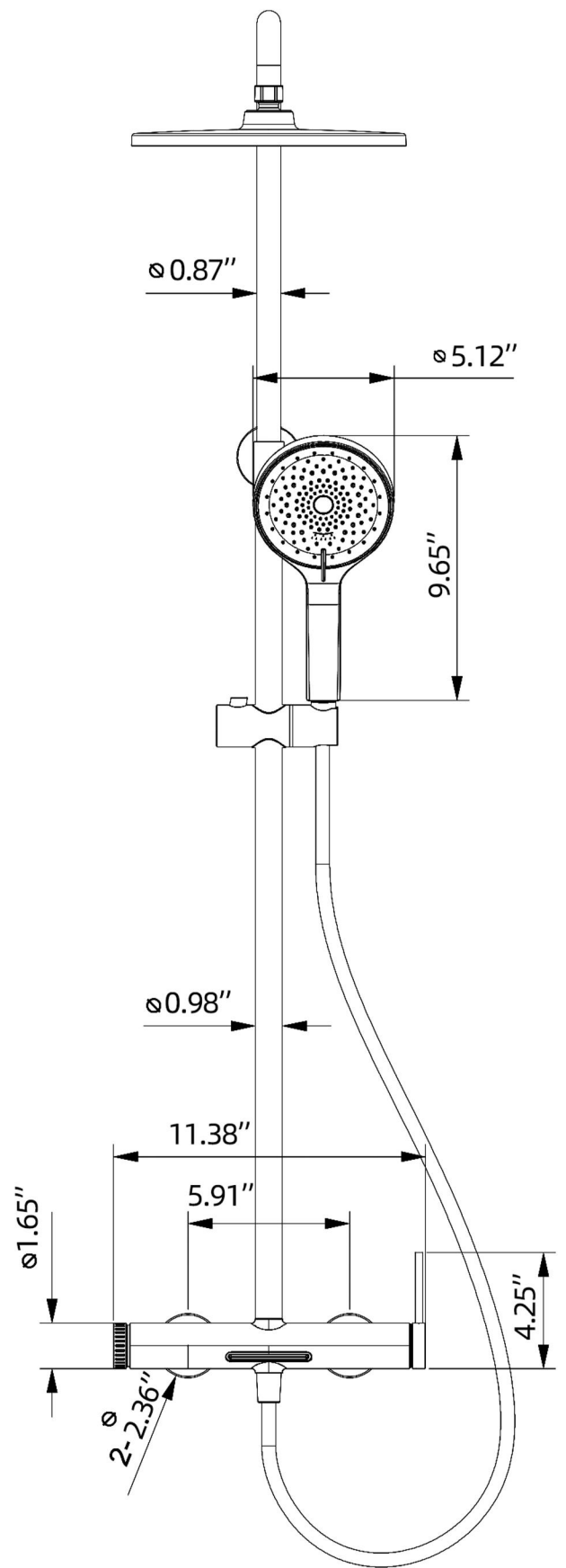
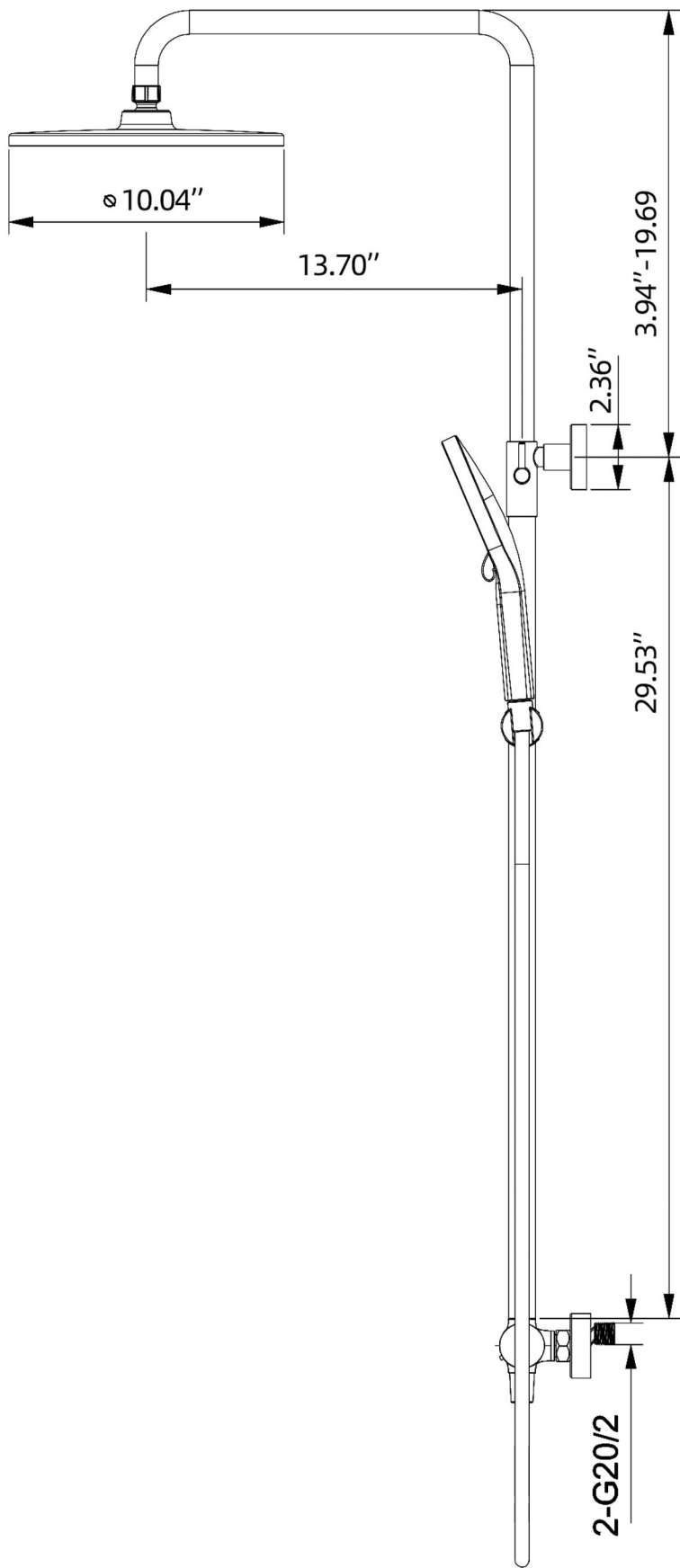

INSTALLATION STEPS

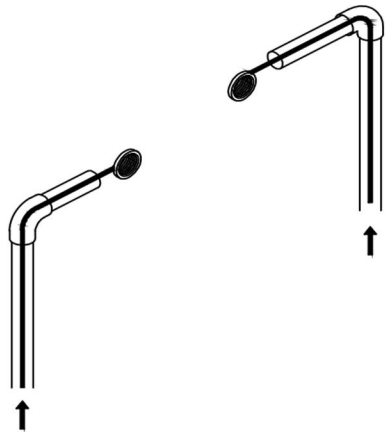
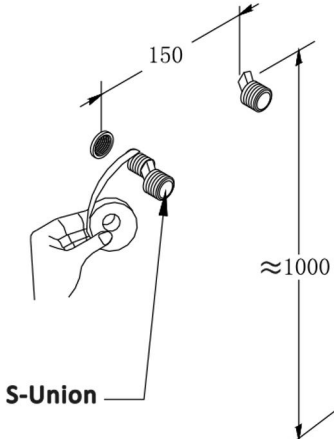
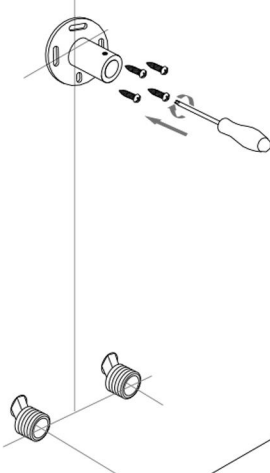
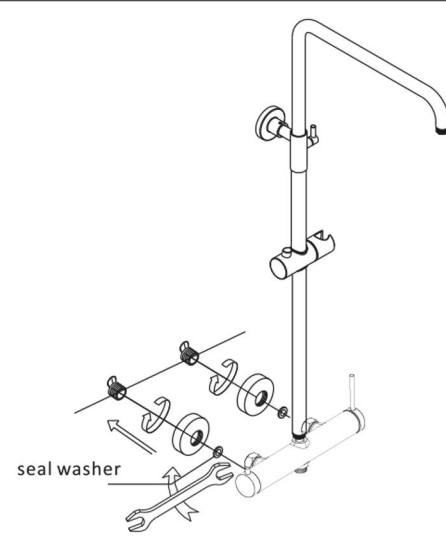
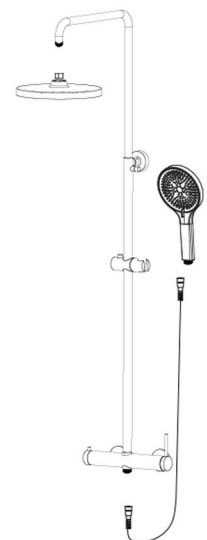
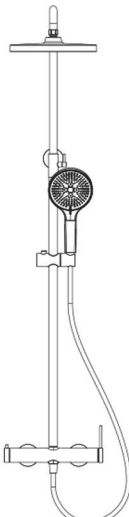
<p>1</p> 	<p>2</p>  <p>S-Union</p>
<p>a) The embedded pipeline must be flushed before installing the faucet.</p>	<p>b) The S-Union is wrapped with raw material tape and connected with the buried outlet pipe joint.</p>
<p>3</p> 	<p>4</p>  <p>seal washer</p>
<p>c) According to the size of the shower pipe, the fixing base is fixed on the wall with self-tapping screws.</p>	<p>d) Tighten the main body and the S-Union, and fix the shower pipe to the upper wall fixer at the same time.</p>
<p>5</p> 	<p>6</p> 
<p>e) Connect the hand shower and head shower to the shower pipe and the main body separately.</p>	<p>f) Turn on the water source switch and check whether there is water leakage at each connection.</p>

Care and maintenance

To keep the surface of the faucet smooth and bright, please follow the procedure below:

- a) Often clean the surface of the faucet with water, and dry the faucet with a soft cloth.
- b) Do not rub the surface of the faucet with detergents such as polishing powder and decontamination powder to avoid abrasion and scratching the product.
- c) Never use acid detergent to clean the faucet, so as not to cause acid detergent to corrode the faucet plating layer.
- d) When using the product, please do not operate the movable parts of the product with force, so as not to affect the service life of the product.



**Please Do Not Return the Product to the Store.
Contact us with any questions.**