





ASSEMBLY INSTRUCTIONS.

SECTIONAL RIGHT

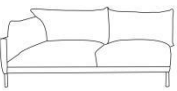
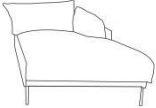

THANK YOU FOR YOUR PURCHASE!

PARTS AND HARDWARE.

No.	Description	IMAGE	QTY
P1	2 SEATER		1
P2	CHAISE		1
P3	SCREW		16
P4	Flat		16
P5	Wrench		1
P6	Metal leg		8

NOTES.

Thank you for purchasing this quality product! Be sure to check all packing material carefully.

Caution: The item is heavy, assembly should be performed by two people.

STEP 1.

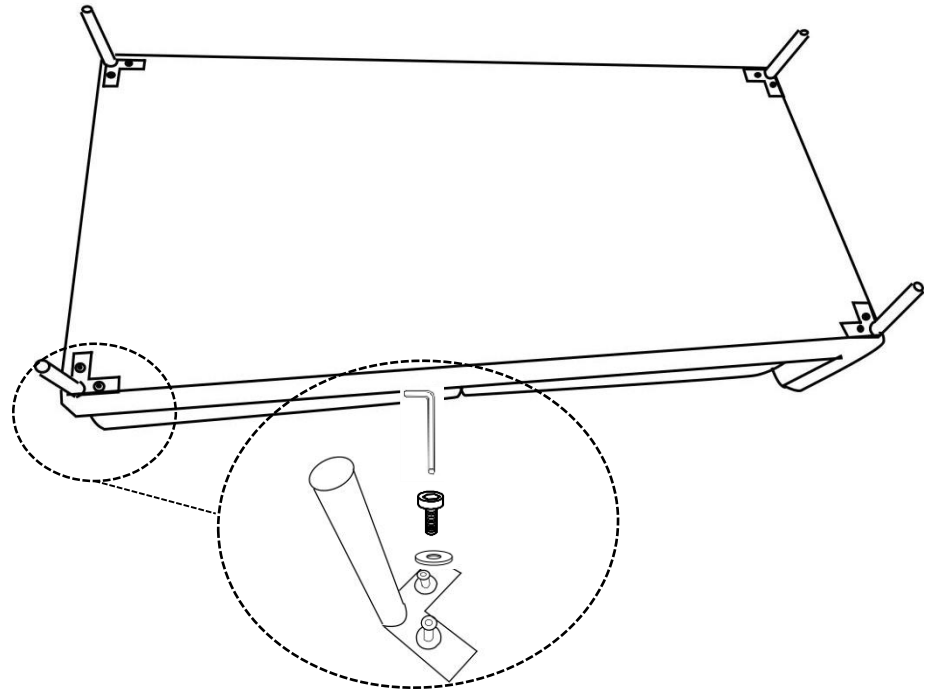

STEP 2.

