

# ASSEMBLY INSTRUCTIONS

## BATHROOM VANITY



PRODUCT  
INSTRUCTION  
VIDEO

# PRODUCT SIZE: 42"





**NOTE:** Any size of the vanity's installation steps are the same.

## INSTALLATION STEPS

**1. Prepare the Vanity:** Make sure the vanity is in place and securely attached to the wall.

**2. Seal the Edges:** To prevent water damage and ensure a clean finish, apply a bead of silicone caulk along the edges where the countertop meets the vanity.

(For Example)

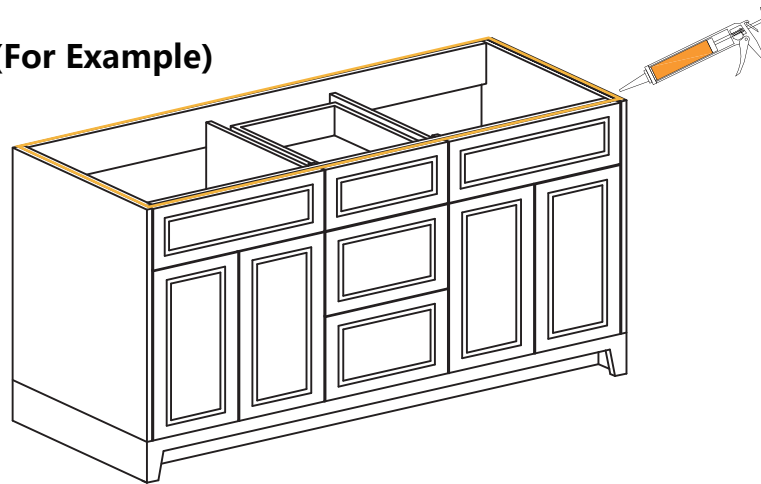

**3. Attach the Countertop:** Secure the solid surface countertop on the vanity.

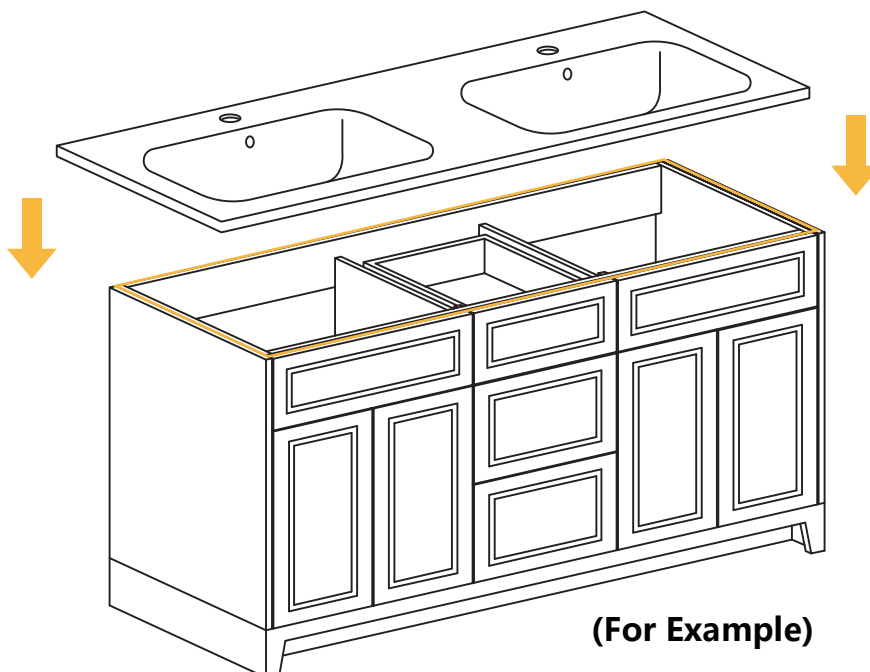

(For Example)

# HOME SERVICES



INSTALLATION VIDEO

## Missing Part or Defective?

Please Contact the Customer Service Team

✉ [service@getprohome.com](mailto:service@getprohome.com)

☎ 626 679 3588