

1. Place the cabinet at the required height, and mark the holes and walls in the cabinet with a marker pen.

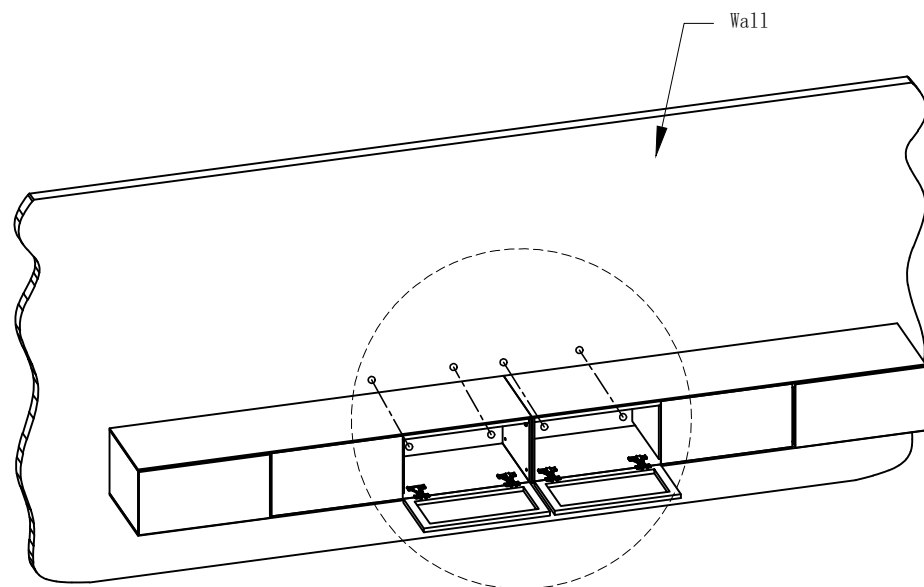

(1) After marking the position with a marking pen, use an electric drill to drill holes in the wall

punching by electric rotation
(Drill to a depth of 80mm using a 12mm diameter drill bit)

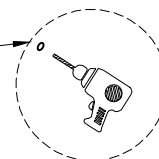

(2) Use a hammer to drive the expansion screw into the wall hole

Wall entry expansion
(M8*80)

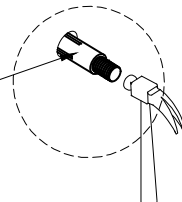

(3) Align the cabinet with the expansion screw, put in the nut and tighten it

hole position in cabinet

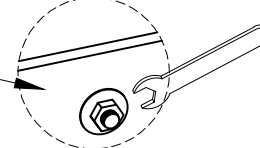

2. Place the support frame at the corresponding position at the bottom of the cabinet, and mark the location of the hole punched into the wall with a marker pen, and then punch the hole

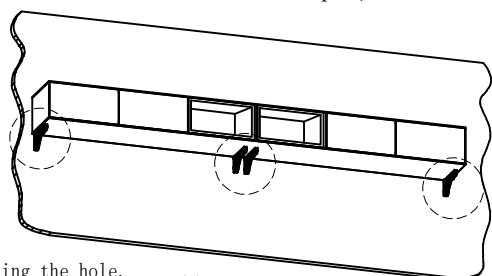

(1) After drilling the hole, drive the expansion screw into the wall with a hammer

(2) Put in the nut and tighten it

(3) Tighten the self-attack screw with a screwdriver

Wall entry expansion
(M6*60)

self-attack
screw (M4*12mm)

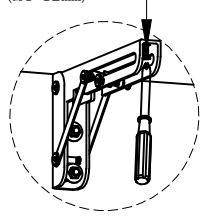
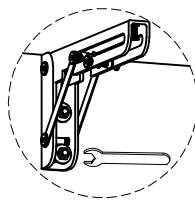
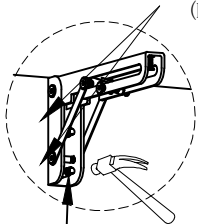

(Drill to a depth of 60mm using a 10mm diameter drill bit)

3. Installation completed

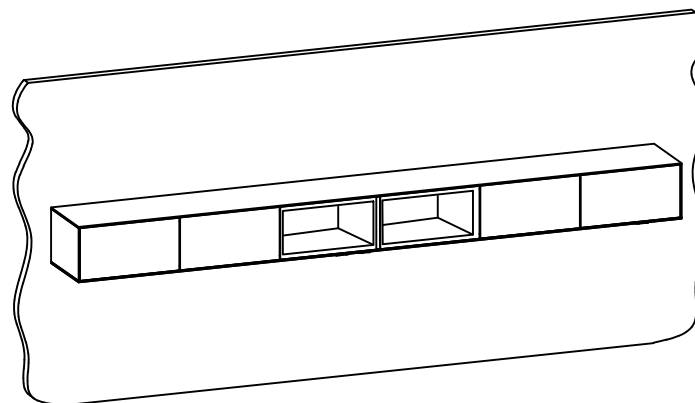

Assembly instructions

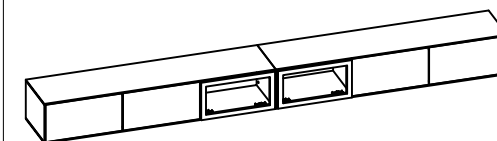

Installation

The number of people needed for installation: 2

- ① Please read the manual carefully before installing this product. And strictly follow the installation process
- ② Please take good care of this manual for your next installation
- ③ Note: Before installation, screw all the screws to 1/2 of the length of the installation. After all screws are half screwed in, tighten them all together.

| Parts list | | On a red ribbon are furniture installation accessories | | |
|---------------|-------|--|------------------------------------|----------------|
| Serial number | Shape | Name | Quantity required for installation | Spare quantity |
| A | | wall entry expansion screw (M8*80mm) | 4 | 0 |
| B | | wall entry expansion screw (M6*60mm) | 8 | 0 |
| C | | self-attack screw (M4*12mm) | 4 | 0 |
| D | | TV cabinet support frame | 4 | 0 |
| E | | | | |
| F | | | | |
| G | | | | |