

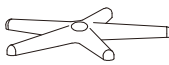





PART Pièce Pieza		Qty Qte Ctd
A		5
B		1
C		1
D		1
E		1
F		1
G		4
H		1

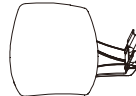

ATTENTION / ATTENTION / ATENCION

Make sure all bolts and screws are fully tightened before using chair. Lubricate all moving parts and tighten all bolts/screws every 6 month or whenever needed.

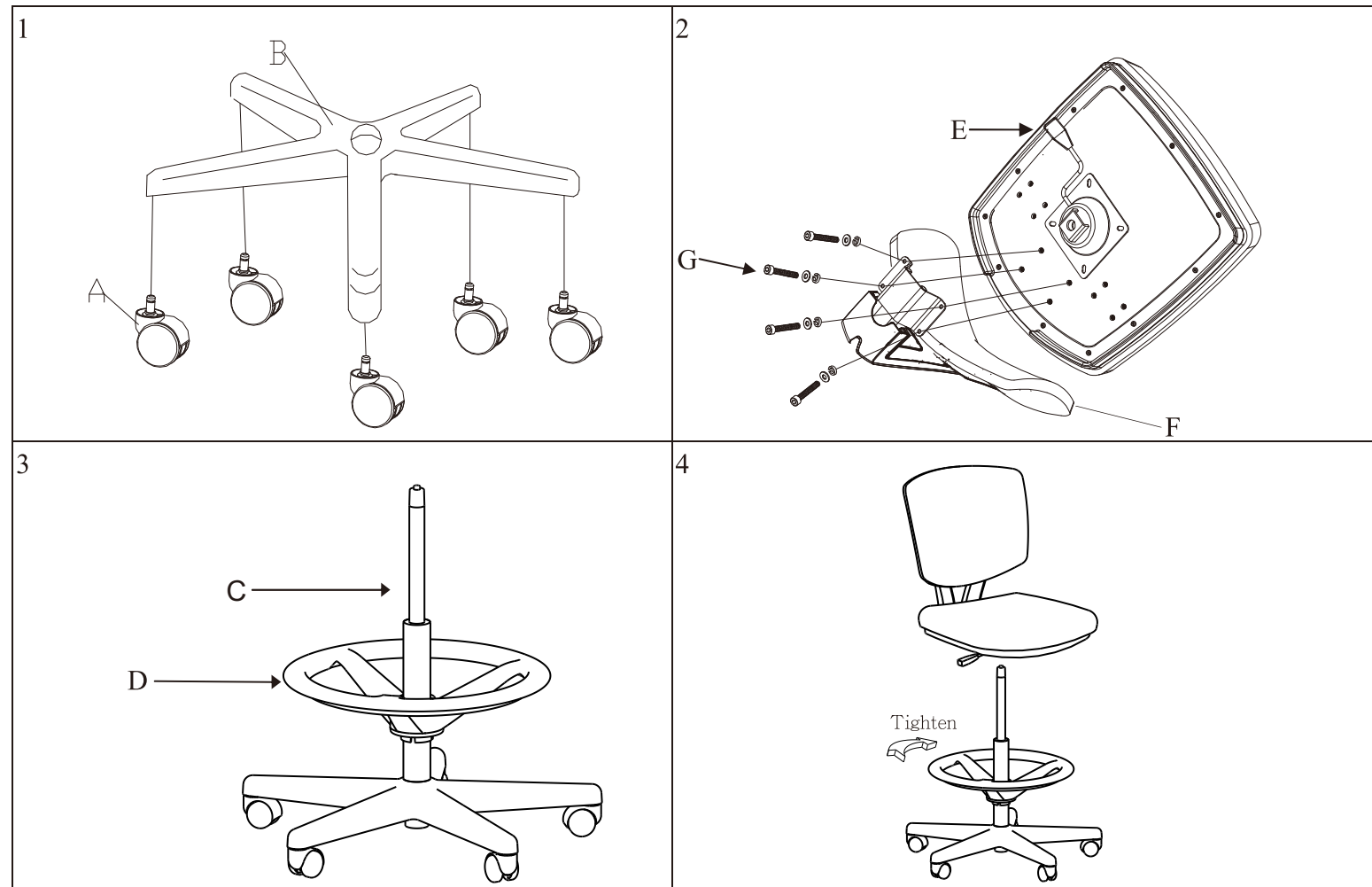
S'assurer que tous les boulons et vis sont serrés à fond avant d'utiliser la chaise. Lubrifier toutes les pièces mobiles et serrer tous les boulons/vis tous les 6 mois ou selon le besoin.

Asegúrese que todos los pernos y tornillos estén completamente apretados antes de usar la silla. Lubrique todas las piezas móviles y apriete todos los pernos/tornillos cada 6 meses o como sea necesario.

▲ WARNING / AVERTISSEMENT / ADVERTENCIA

To ensure proper assembly, follow all steps and use all parts. Failure to follow this warning can result in serious injury to yourself or others.

Effectuer toutes les opérations et utiliser toutes les pièces pour être sûr que l'assemblage est correct. L'inobservation de cet avertissement peut entraîner des blessures graves pour soi ou pour les autres.

Para asegurar un armado correcto, siga todos los pasos indicados y utilice todas las piezas. Si no se observa esta advertencia, se pueden causar lesiones graves a su persona o a los demás.