

# INSTALLATION INSTRUCTIONS

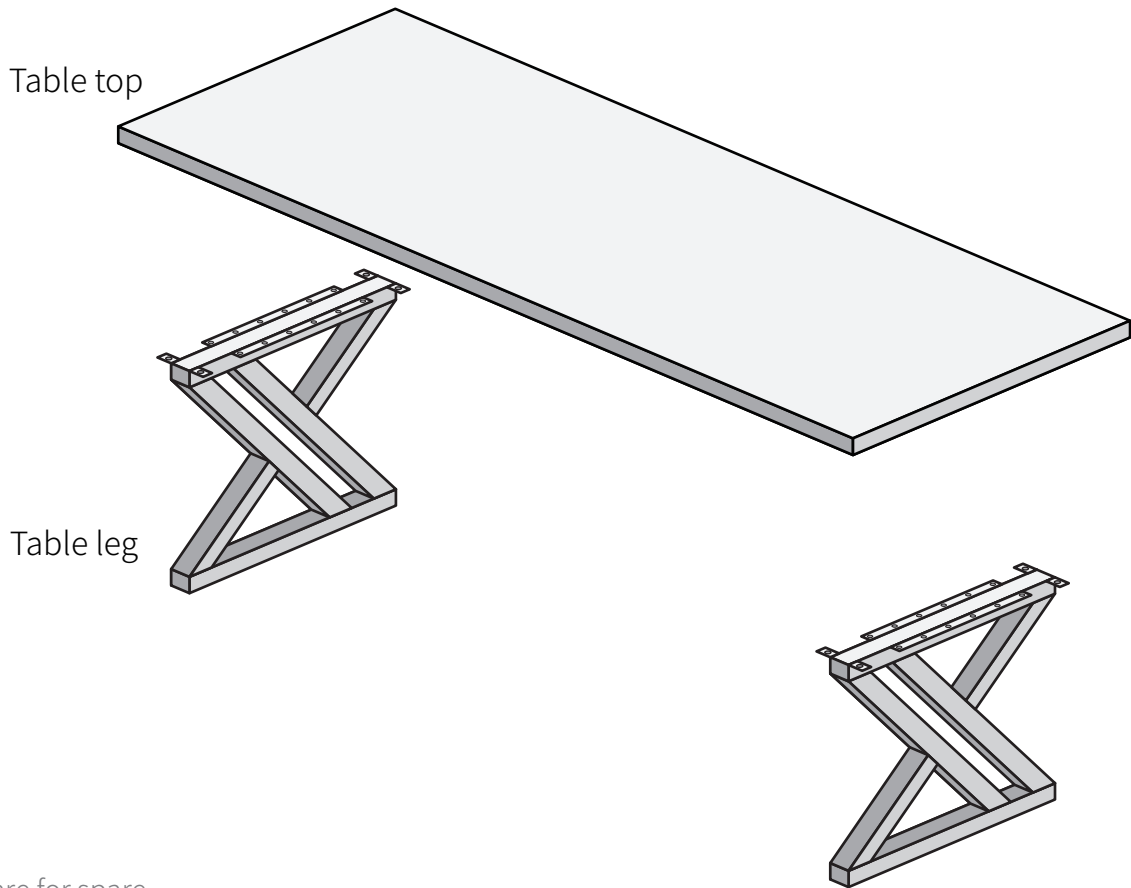

## PARTS LIST

The extra parts are for spare

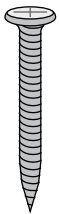

Tapping screw x24

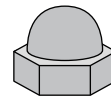

Nut cap x8

On the back surface of the table

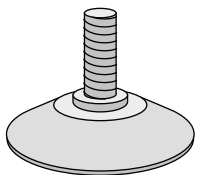

Adjustable foot pads  
x4

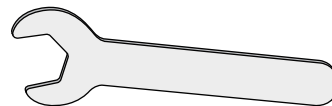

Wrench

## MAINTENANCE OF FURNITURE

Solid wood furniture is derived from nature and requires proper maintenance methods

1. Avoid prolonged exposure to strong sunlight
2. Avoid placing it at the air conditioning outlet or near the heater, at least 1.5 meters apart
3. Keep the indoor dry humidity stable, do not dry today wet tomorrow
4. Do not contact high-temperature items directly
5. The water stains on the surface of the furniture should be dried as soon as possible
6. Do not place any corrosive objects on the surface  
(such as alcohol/aromatherapy/nail polish remover/soft rubber and other products)

## STEP 1

Turn the tabletop upside down.  
then unscrew the nut cap.  
Install the table legs on the back of the tabletop.

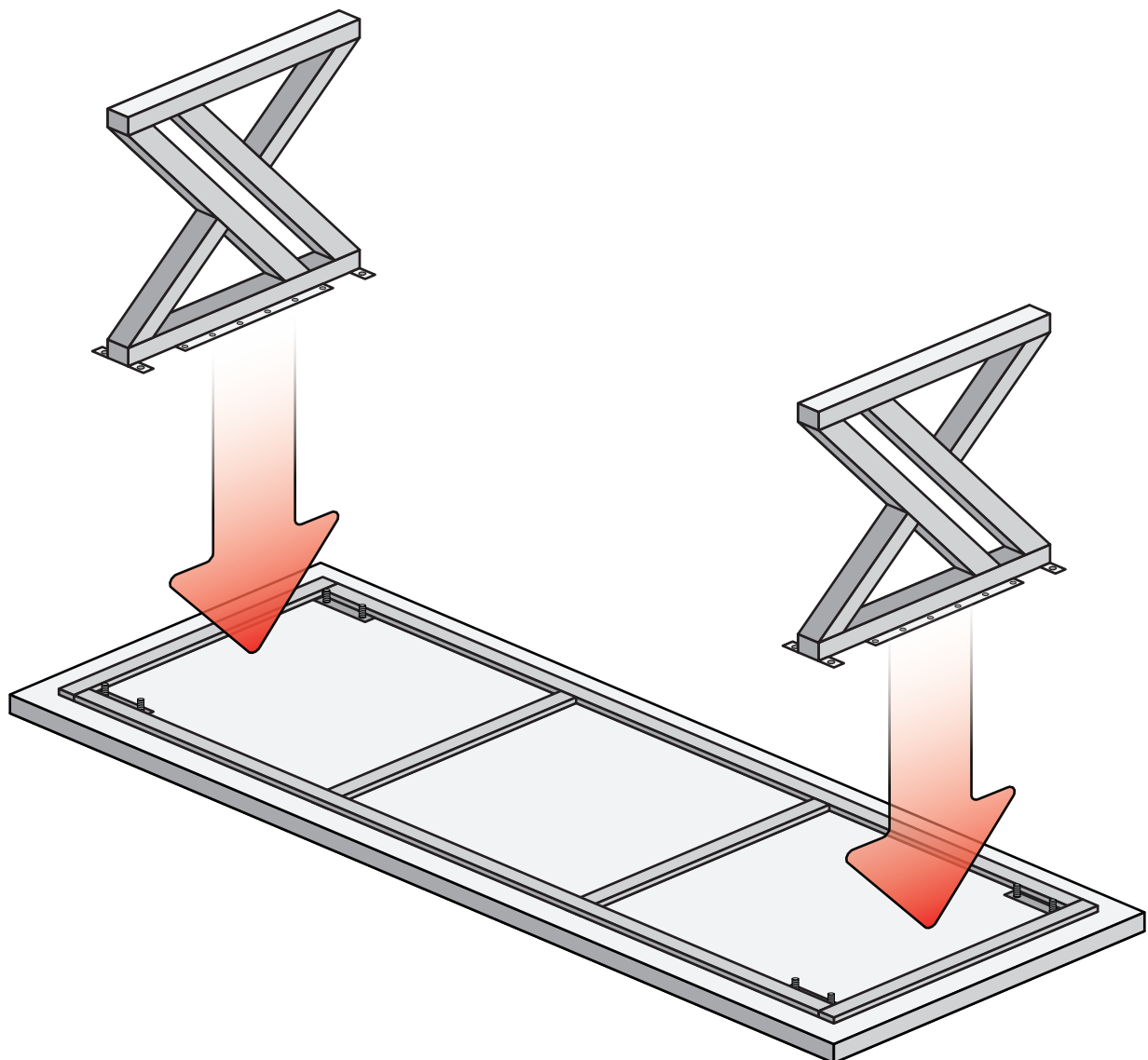
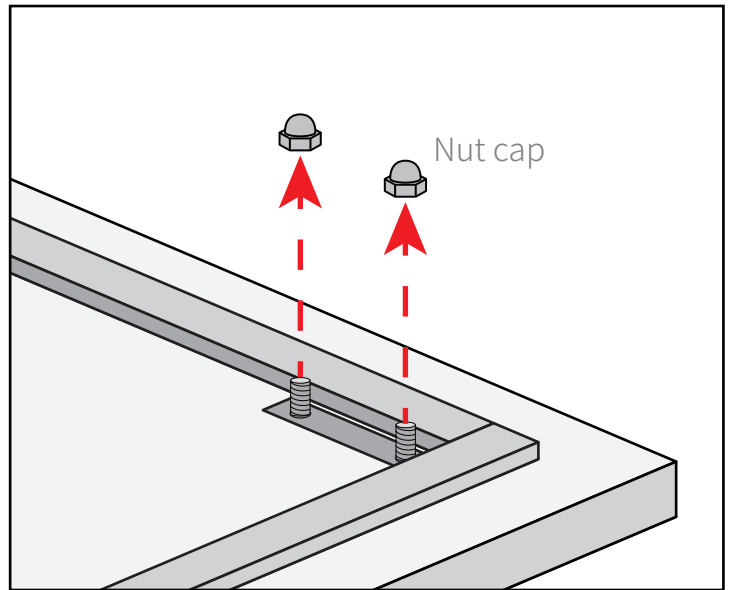

## STEP 2

Fix the table legs with nut caps and self-tapping screws

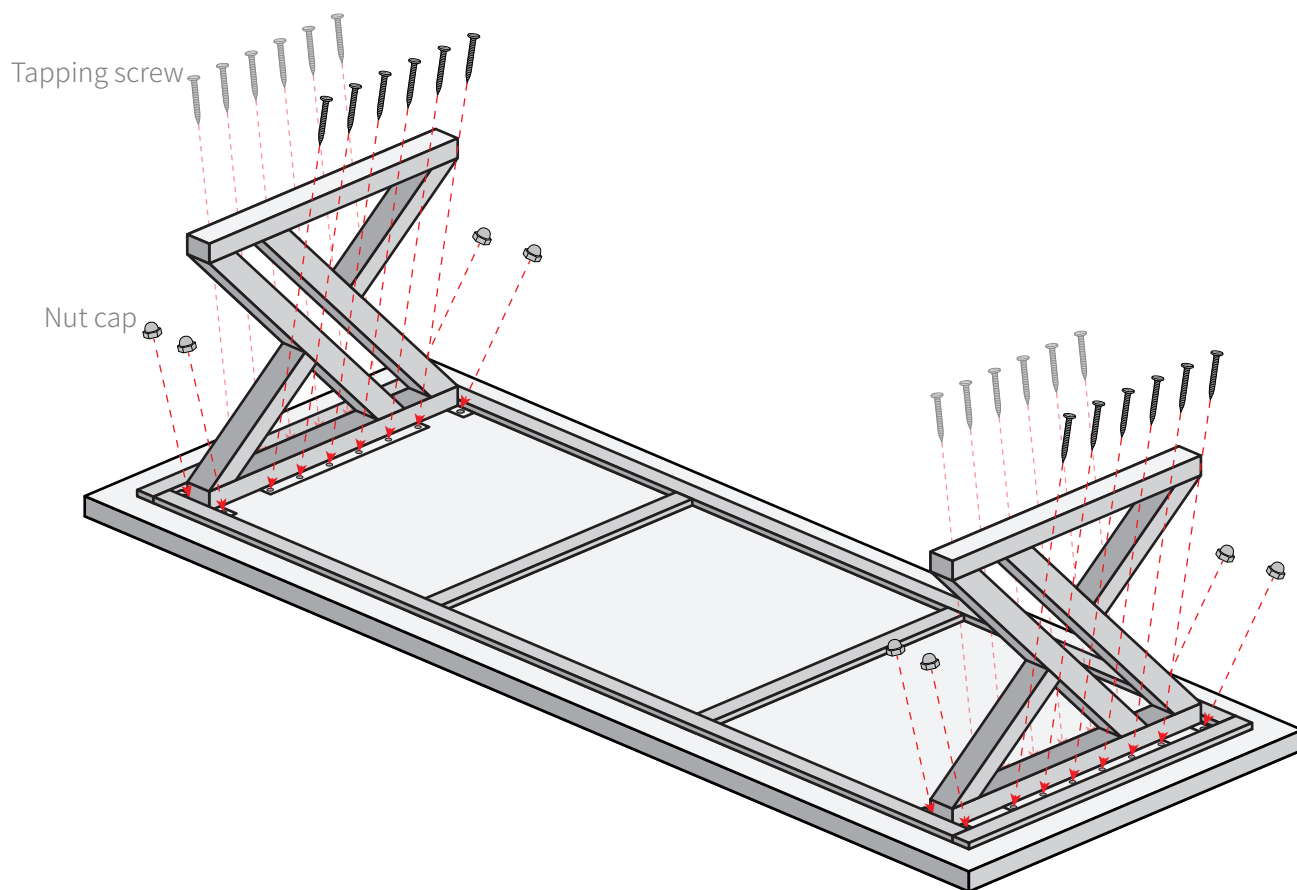
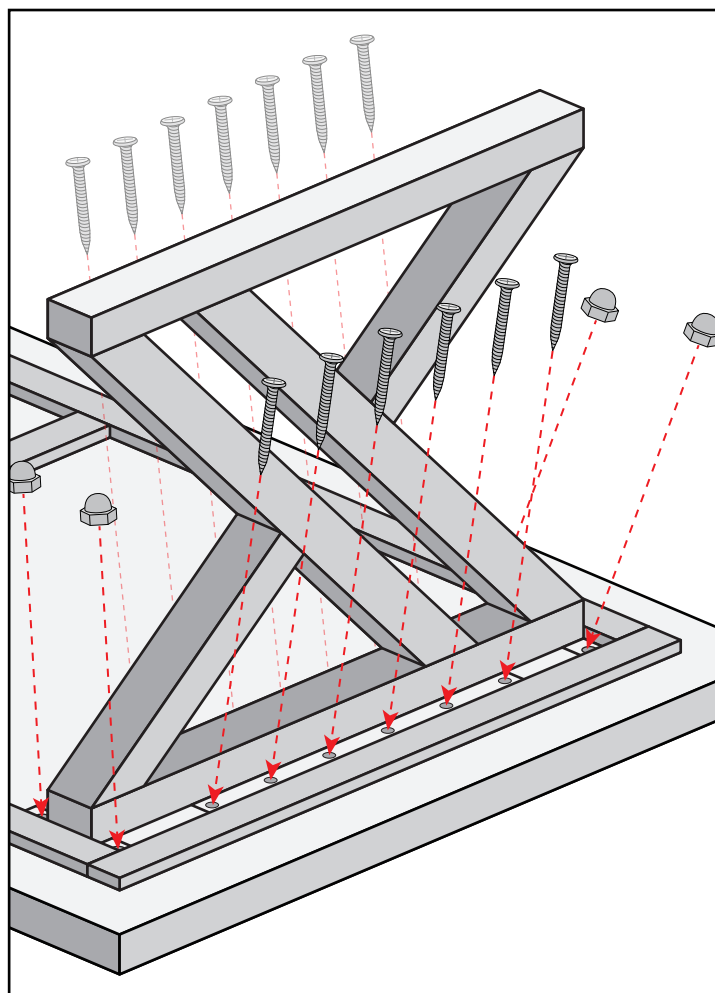

### STEP 3

Install adjustable anti-slip pads at the bottom of the table legs

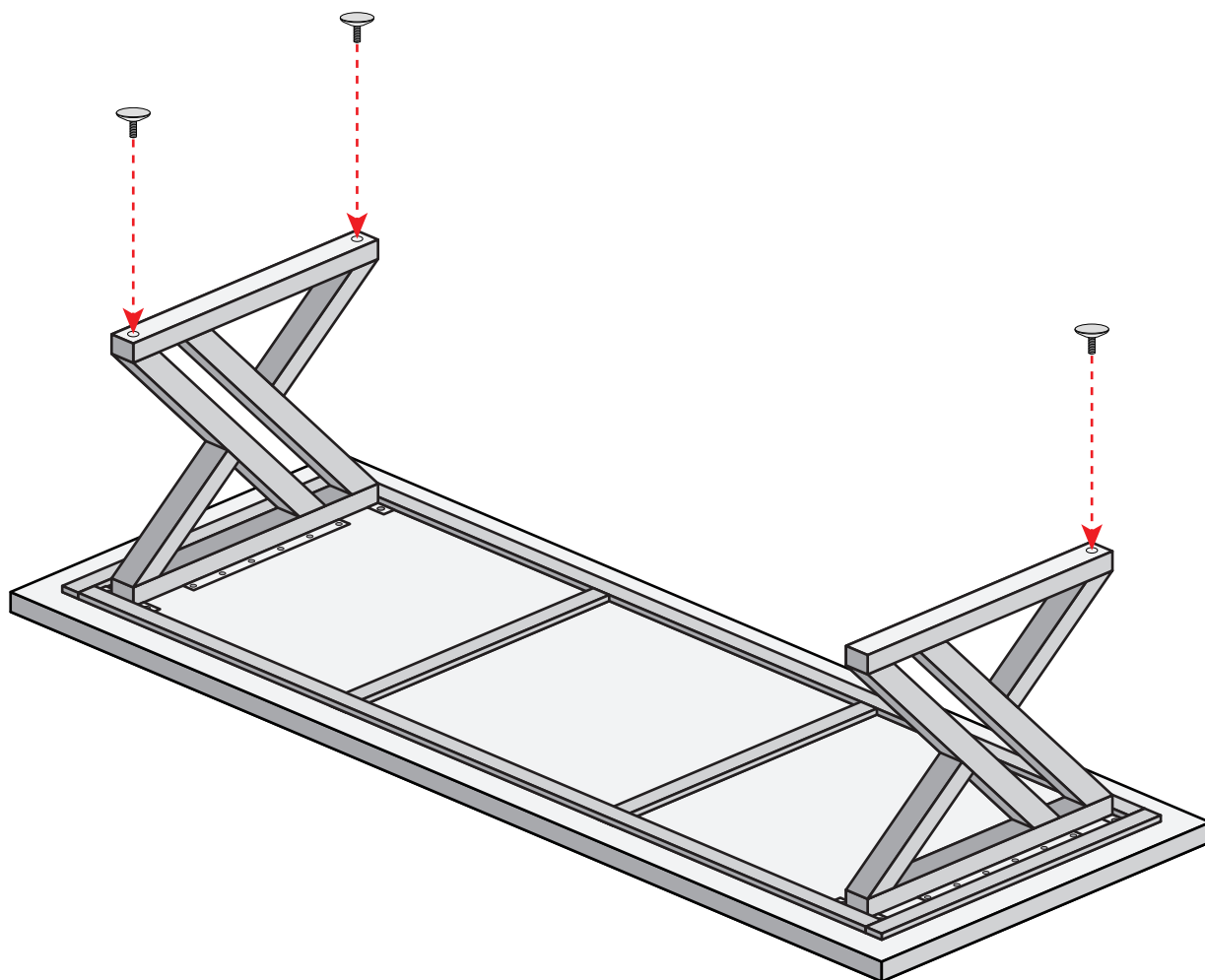

### INSTALLATION COMPLETED

