

ASSEMBLY INSTRUCTION

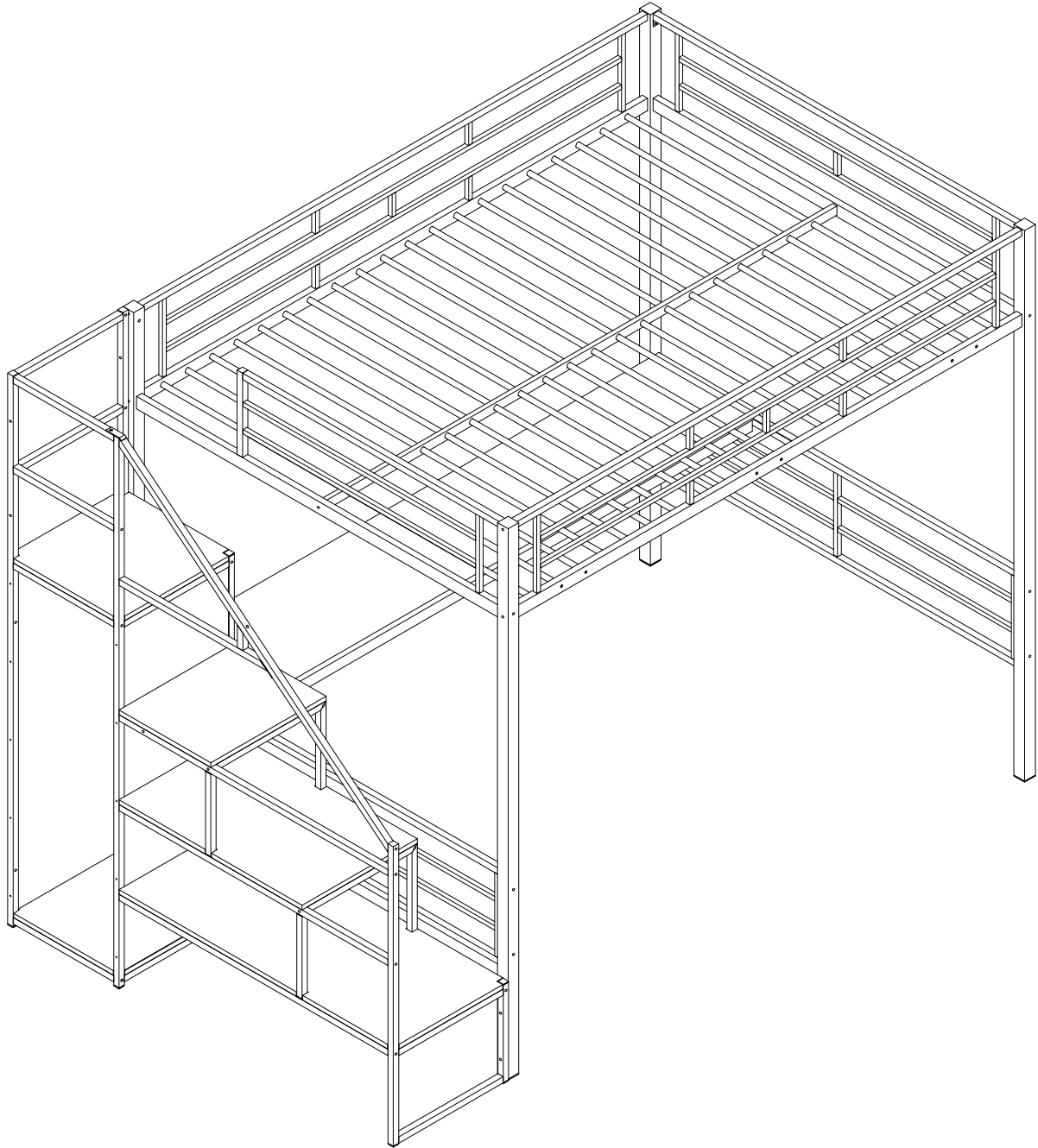

Minimum no. 2 of people
recommended to assemble
this product: Approx.
assembly time: 60 mins

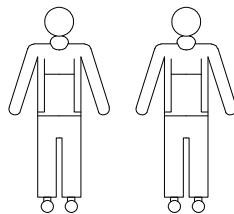

ASSEMBLY INSTRUCTION

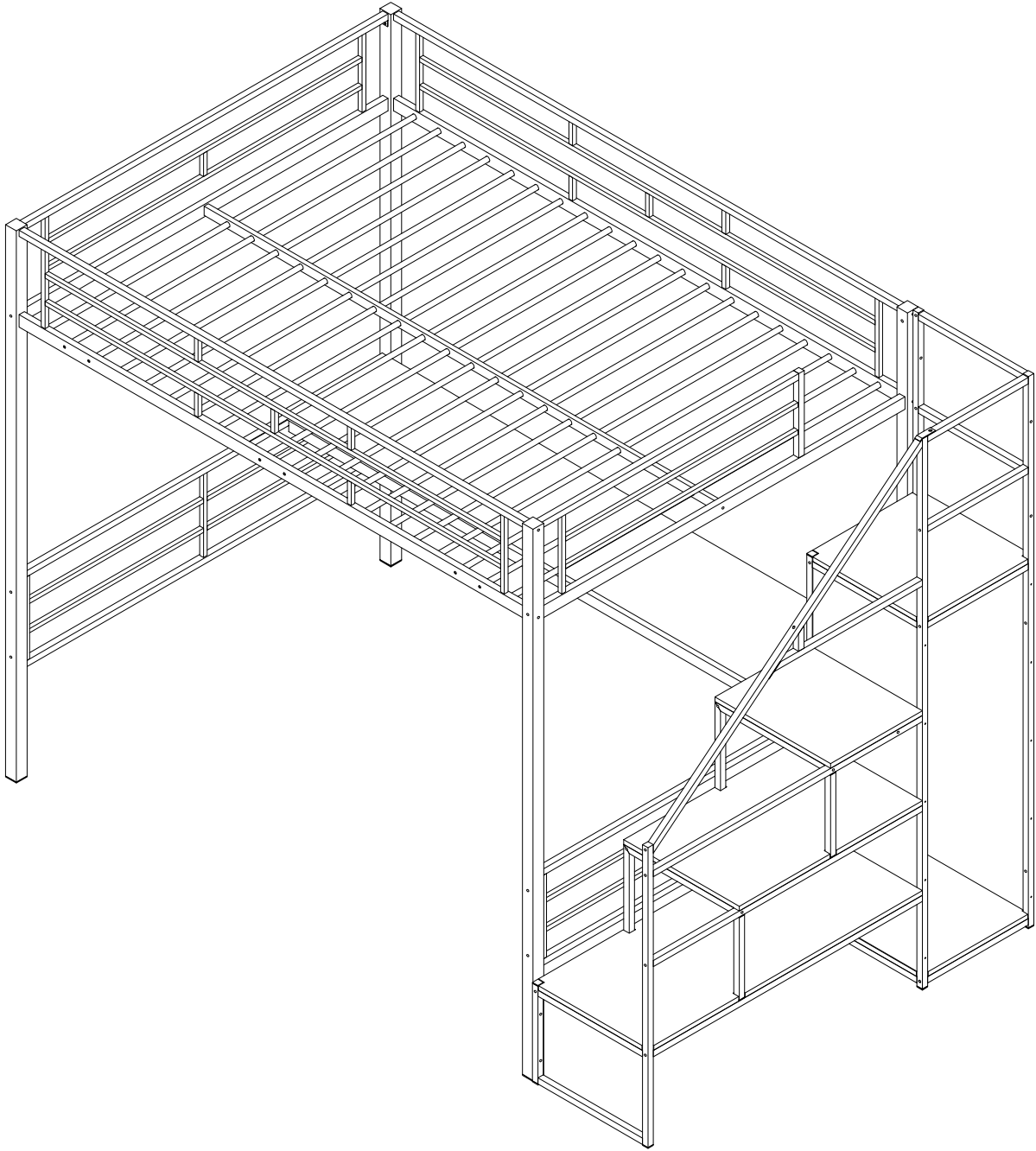

Minimum no. 2 of people
recommended to assemble
this product: Approx.
assembly time: 60 mins

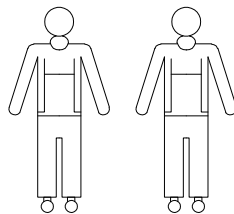

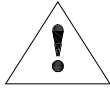

SAFETY WARNING









1. This bed is designed for use only mattress(es) meeting the following specifications on the upper bunk
Upper bunk





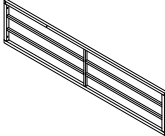
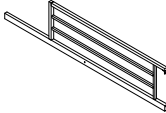
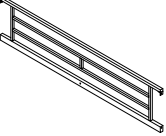
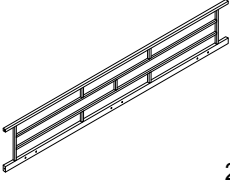
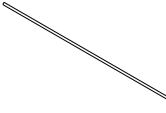
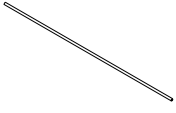
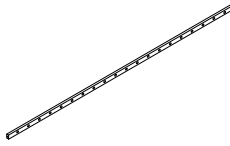
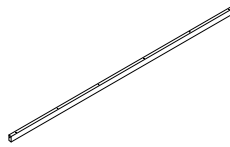

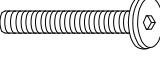

Bed type	Length	Width	Thickness
Full Standard	74"- 75"	53"- 54"	6" Max

2. Replacement parts, including additional guardrails, maybe obtained from any for our
3. Follow the Information on the warnings appearing on the upper bunk bed end structure and on the carton. Do not remove warning label from bed.
4. Always use the recommended size mattresses or mattress supports, or both, to help prevent the likelihood of entrapment or falls.
5. Surface of mattress must be at least 5" (127mm) below the upper edge of guardrails .
6. Do not allow children under 6 years of age to use the upper bunk.
7. Periodically check and ensure that the guardrail , ladder , and other components are in their proper position , free from damage , and that all connectors are tight .
8. Do not allow horseplay on or under the bed and prohibit Jumping on the bed .
9. Always use the ladder for entering and leaving the upper bunk .
10. Do not use substitute part . Contact the manufacturer or dealer for replacement part .
11. Use of a night light may provide added safety precaution for a child using the upper bunk .
12. Always use guardrails on both long sides of upper bunk . If the bunk bed will be placed next to the wall , the guardrail that runs the full length of the bed should be placed against the wall to prevent entrapment between the bed and wall .
13. The use of water or sleep flotation mattresses is prohibited .
14. **STRANGULATION HAZARD** - Never attach or hang items to any part of the bunk bed that are not designed for use with the bed ; for example , but not limited to , hook , belts and Jump ropes .
15. Keep these Instructions for future reference .
16. Prohibit more than one person on upper bunk
17. We recommend assembling your bunk bed on the shipping carton to protect your floor or carpet
18. Be certain all staples are out the box before beginning assembly on the shipping carton .

PART LIST

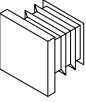
<p>1</p>  <p>1PC</p>	<p>2</p>  <p>1PC</p>	<p>3</p>  <p>1PC</p>
<p>4</p>  <p>1PC</p>	<p>5</p>  <p>2PCS</p>	<p>6</p>  <p>1PC</p>
<p>7</p>  <p>1PC</p>	<p>8</p>  <p>2PCS</p>	<p>9</p>  <p>14PCS</p>
<p>10</p>  <p>6PCS</p>	<p>11</p>  <p>1PC</p>	<p>12</p>  <p>2PCS</p>
<p>25</p>  <p>1PC</p>	<p>32</p>  <p>1PC</p>	

HARDWARE LIST

<p>A</p>  <p>20PCS M$\frac{1}{4}$"X50</p>	<p>B</p>  <p>45PCS M$\frac{1}{4}$"X35</p>	<p>C</p>  <p>25PCS M$\frac{1}{4}$"X15</p>	<p>D</p>  <p>2PCS 20x20</p>
<p>E</p>  <p>1PC M4X23X57</p>	<p>F</p>  <p>4PCS #40x40x16</p>	<p>G</p>  <p>12PCS M4x50</p>	<p>H</p>  <p>54PCS M4x30</p>
<p>i</p> <p>Not included</p>  <p>1PC</p>	<p>j</p>  <p>8PCS #20x20x13</p>		

PART LIST

15

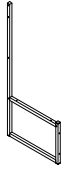

1PC

16



1PC

17

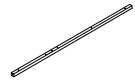

2PCS

18



1PC

19



1PC

20



1PC

21



1PC

22



1PC

23

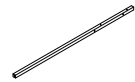

1PC

24



1PC

26



1PC

27



2PCS

28



2PCS

29



1PC

30



1PC

31

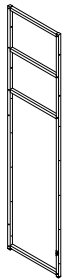

1PC

33

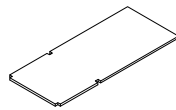

1PC

34

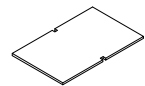

1PC

35



1PC

36

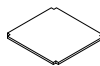

1PC

37

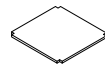

1PC

38



2PCS

13

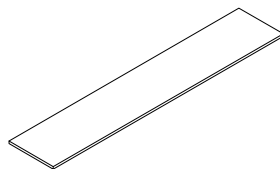

1PC

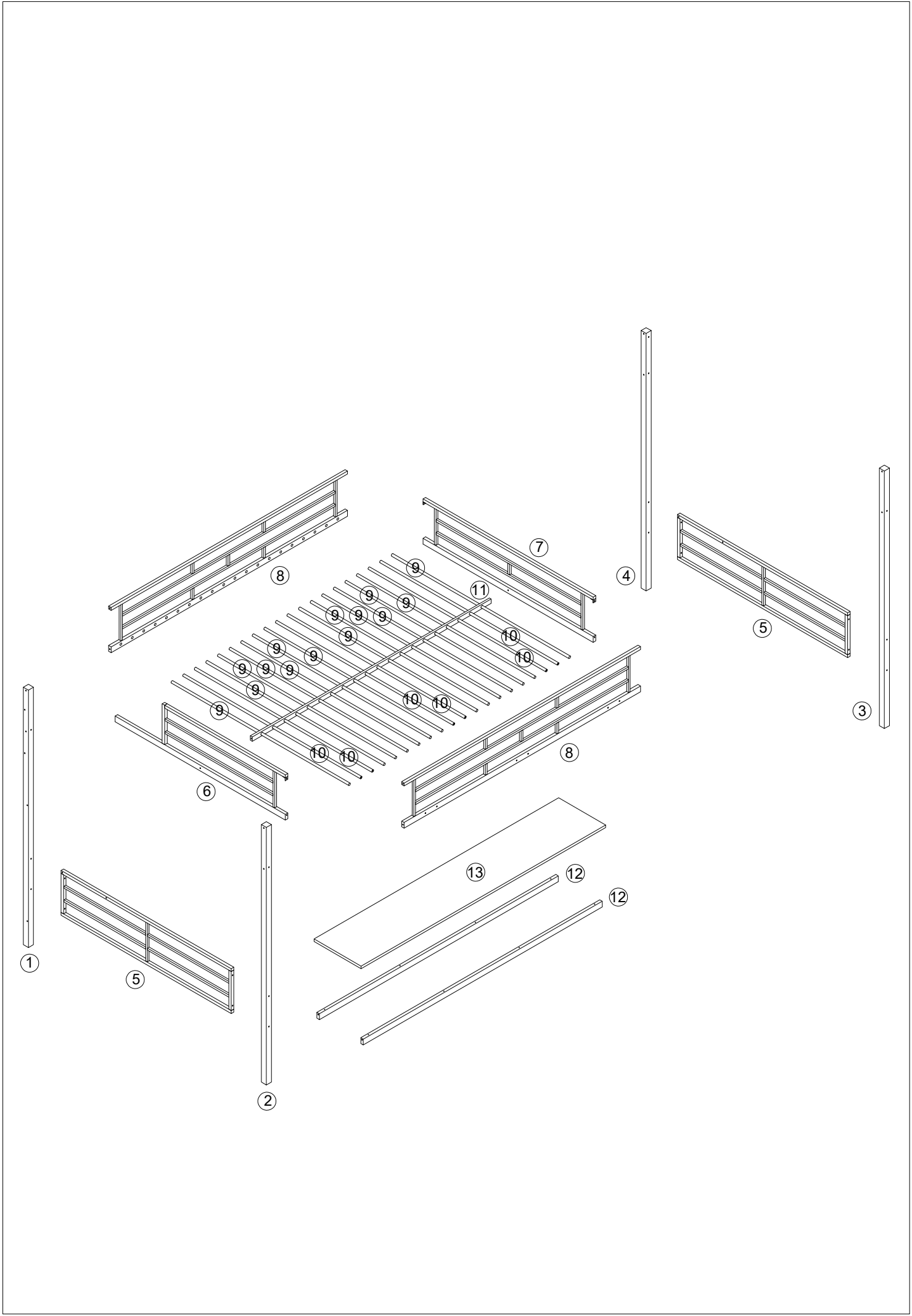

STEP 1

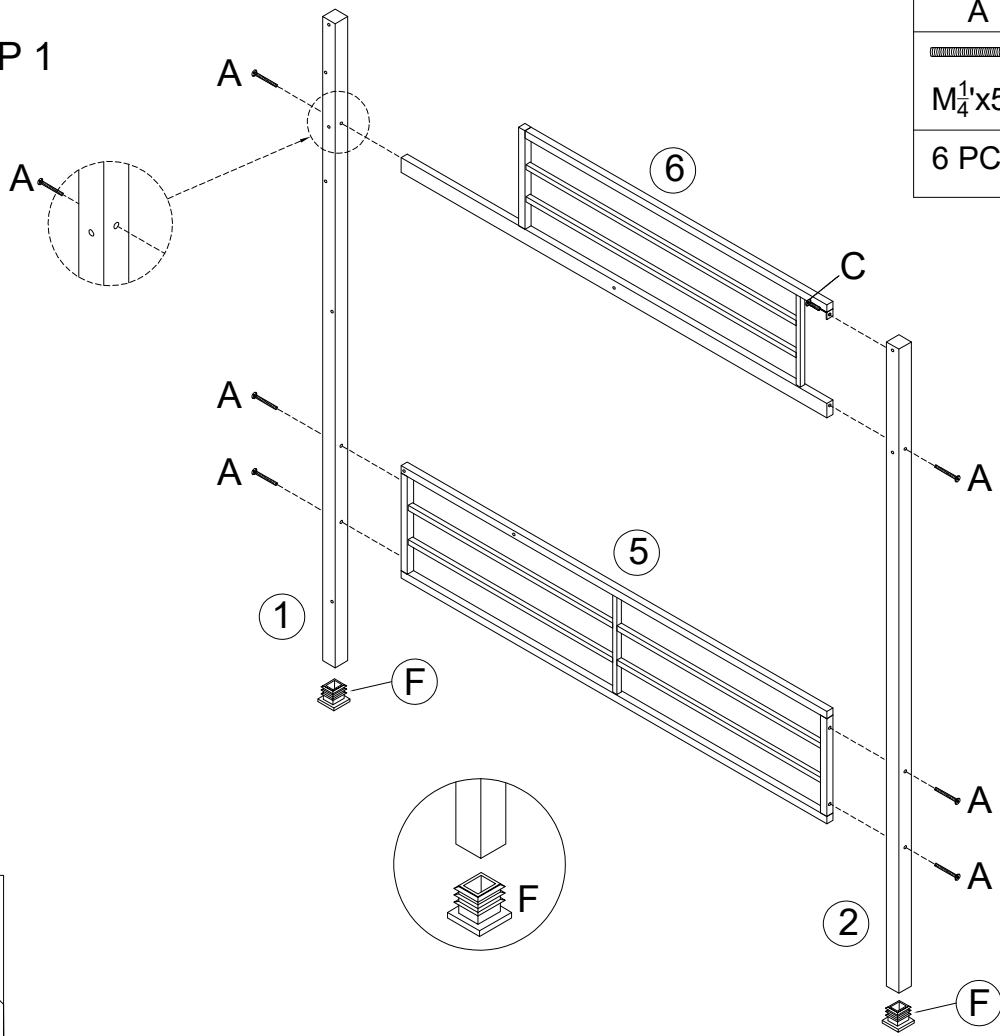

A	C	F
M $\frac{1}{4}$ x50	M $\frac{1}{4}$ x15	#40x40x16
6 PCS	1 PC	2 PCS

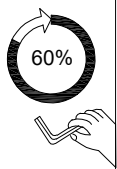

STEP 2

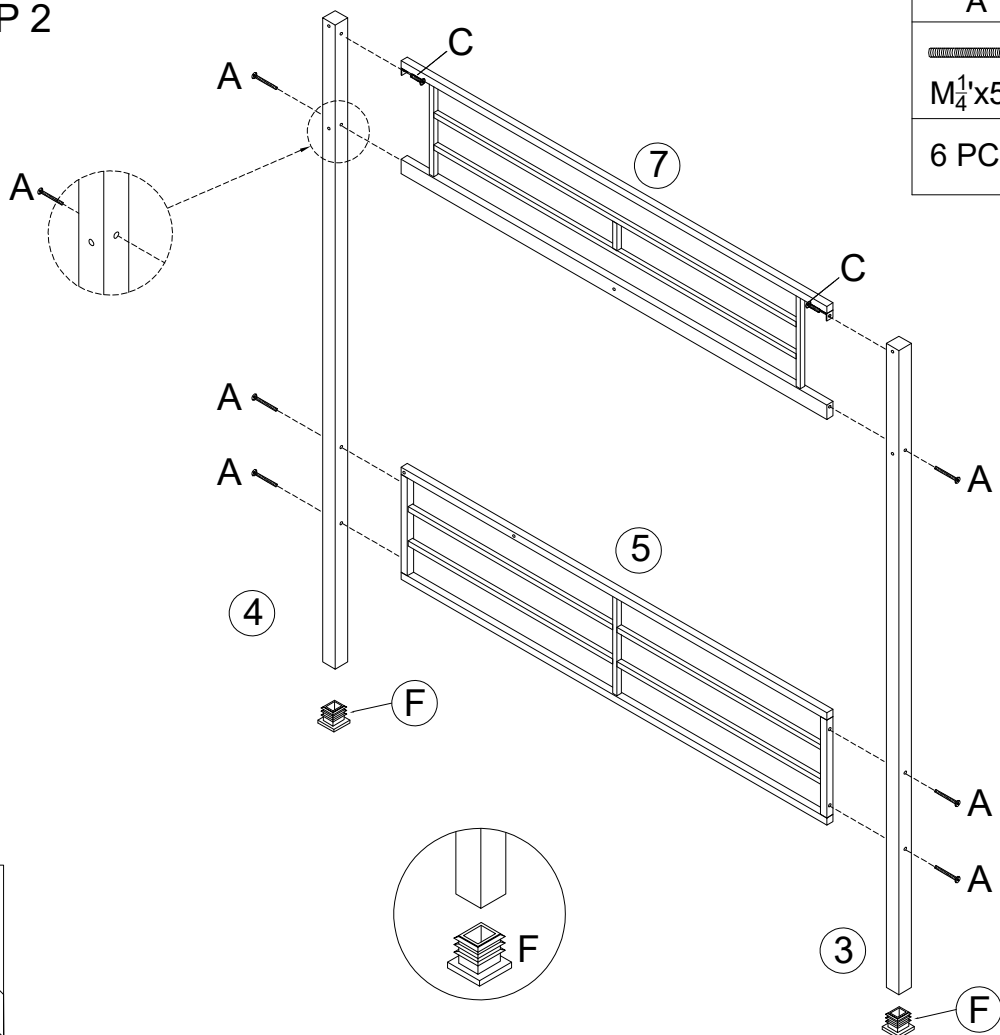

A	C	F
M $\frac{1}{4}$ x50	M $\frac{1}{4}$ x15	#40x40x16
6 PCS	2 PCS	2 PCS

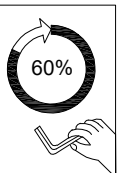

STEP 3

C



M $\frac{1}{4}$ "x15

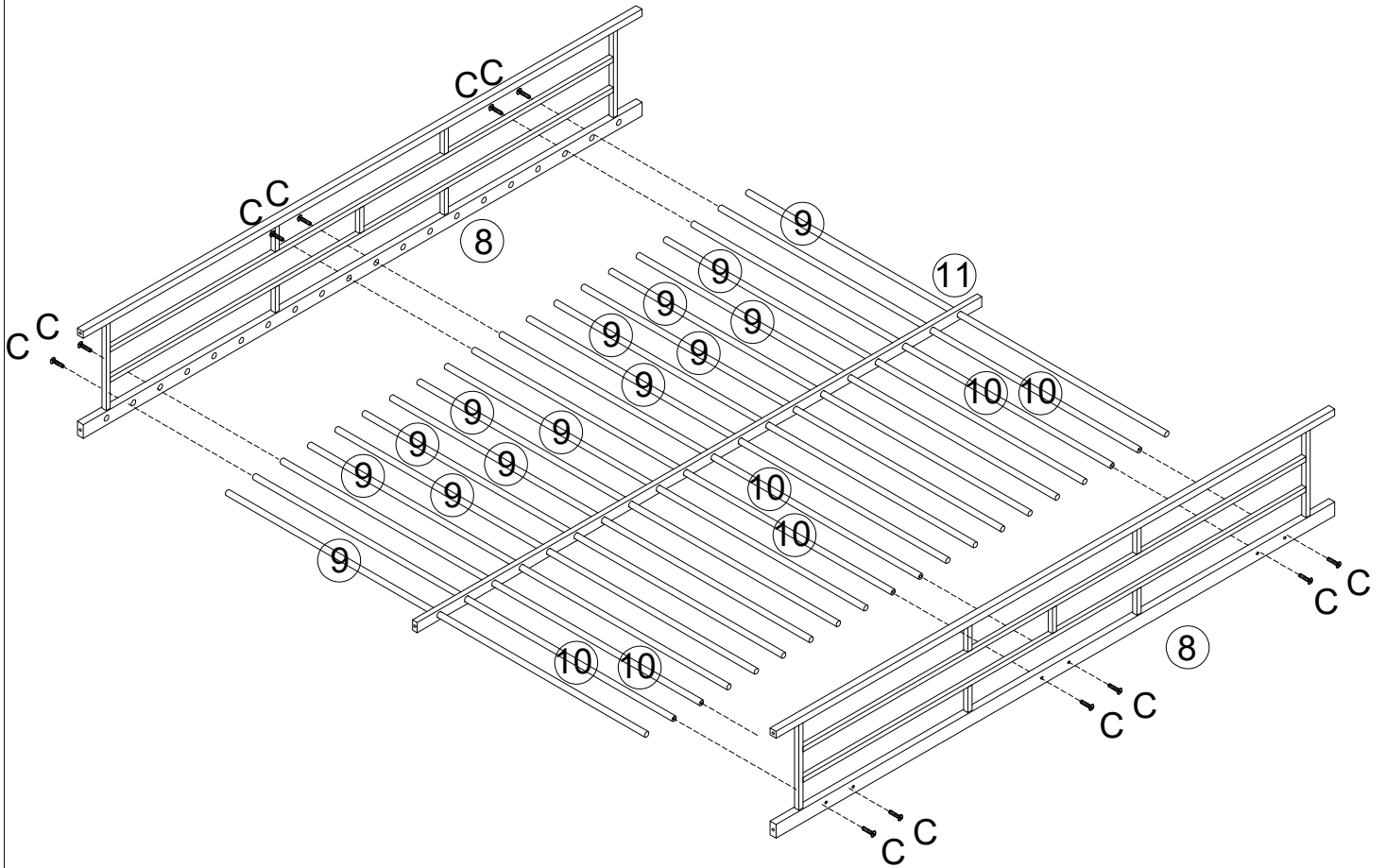

12 PCS



60%



STEP 4

A	B
 M $\frac{1}{4}$ "x50	 M $\frac{1}{4}$ "x35
8 PCS	6 PCS

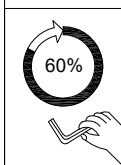
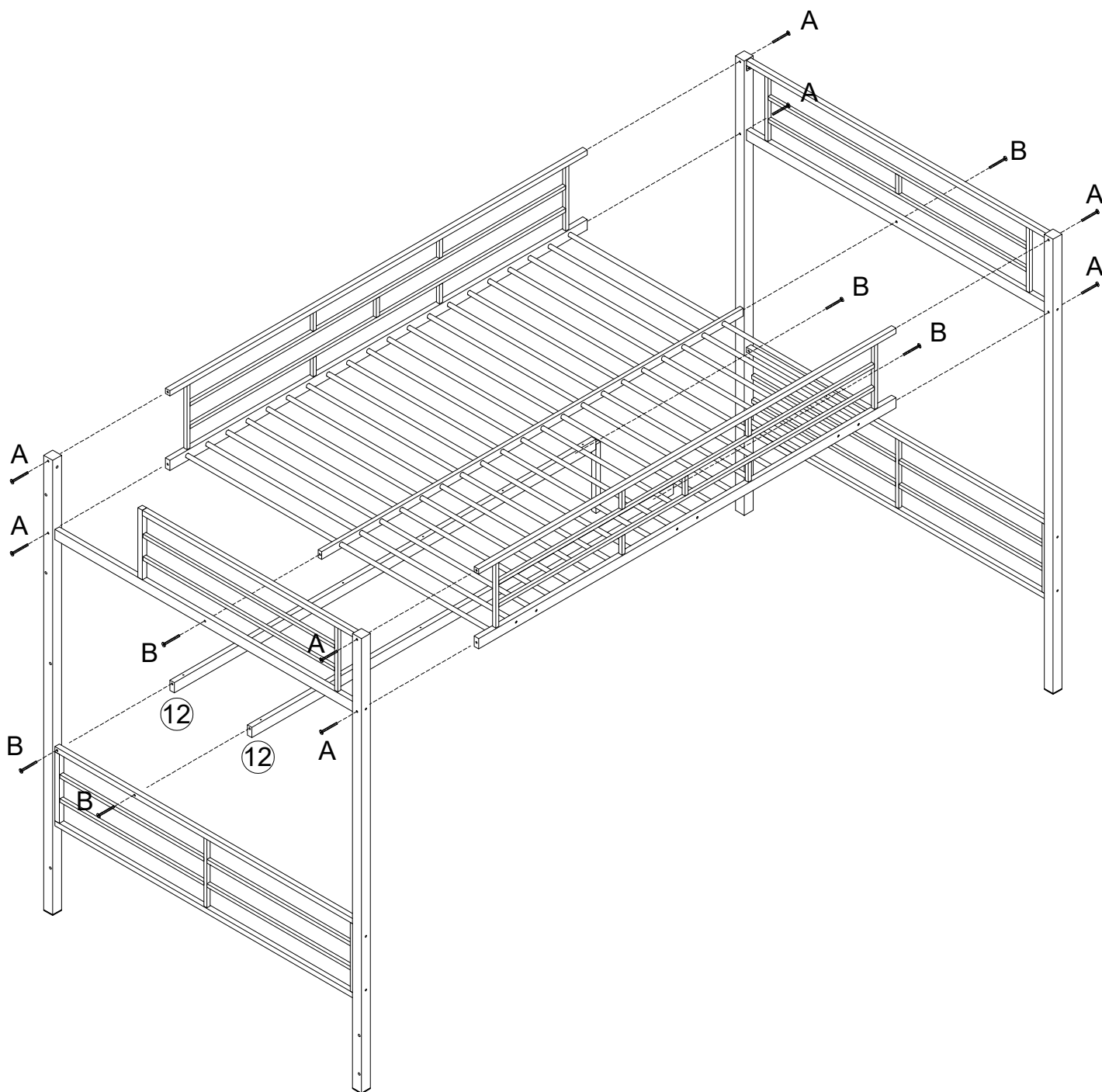

STEP 5

G
 M4x50
12 PCS

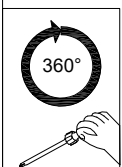
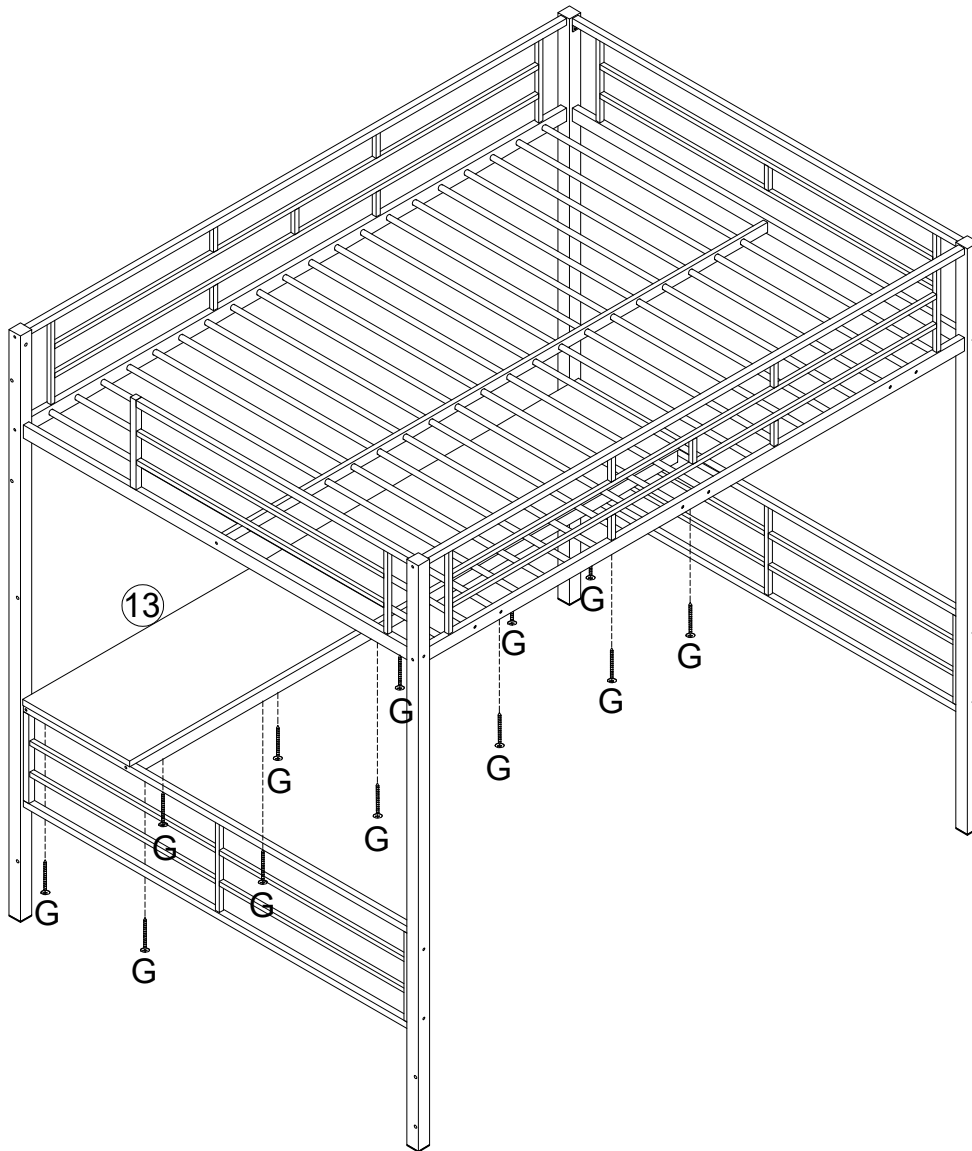

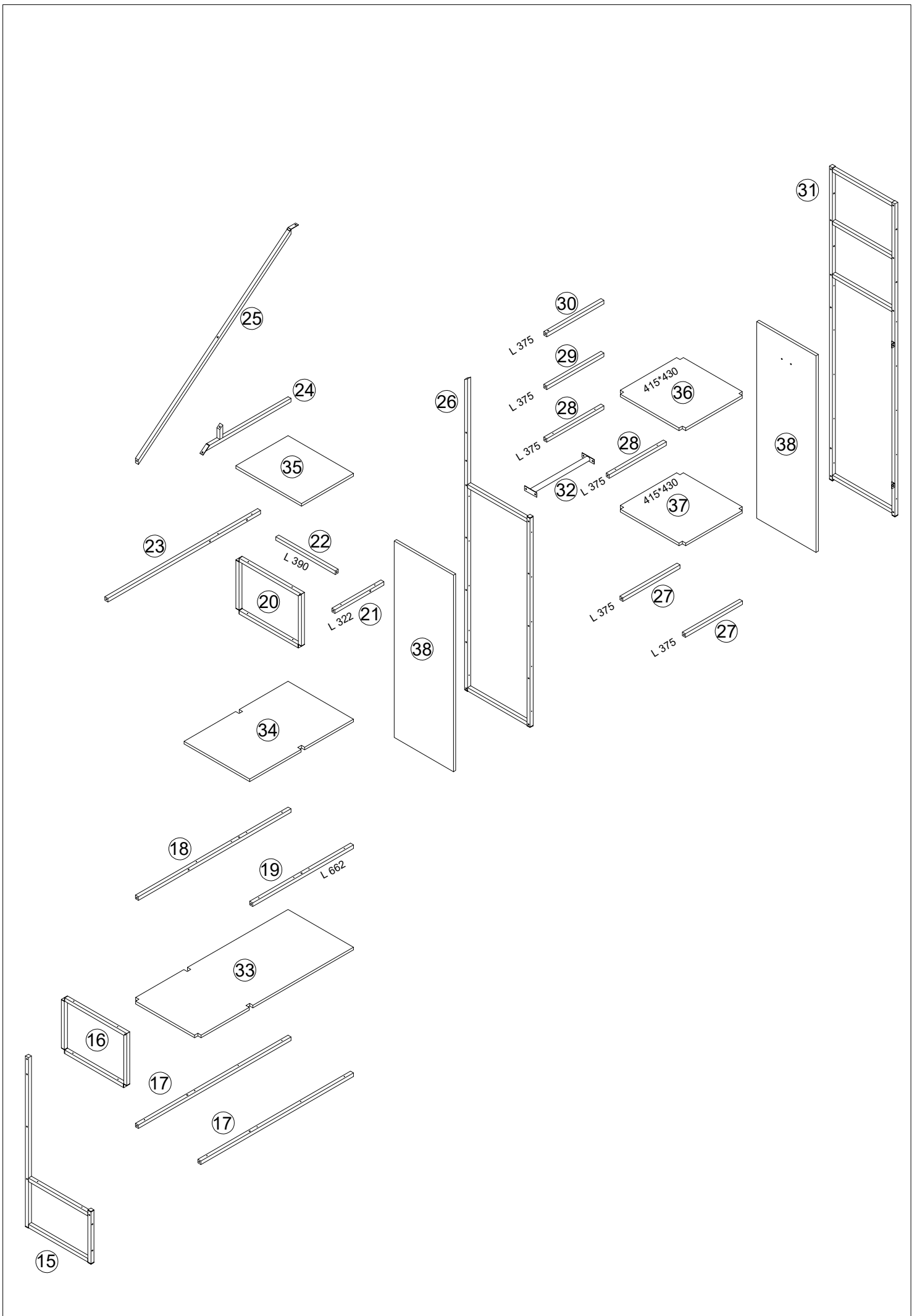

STEP 6

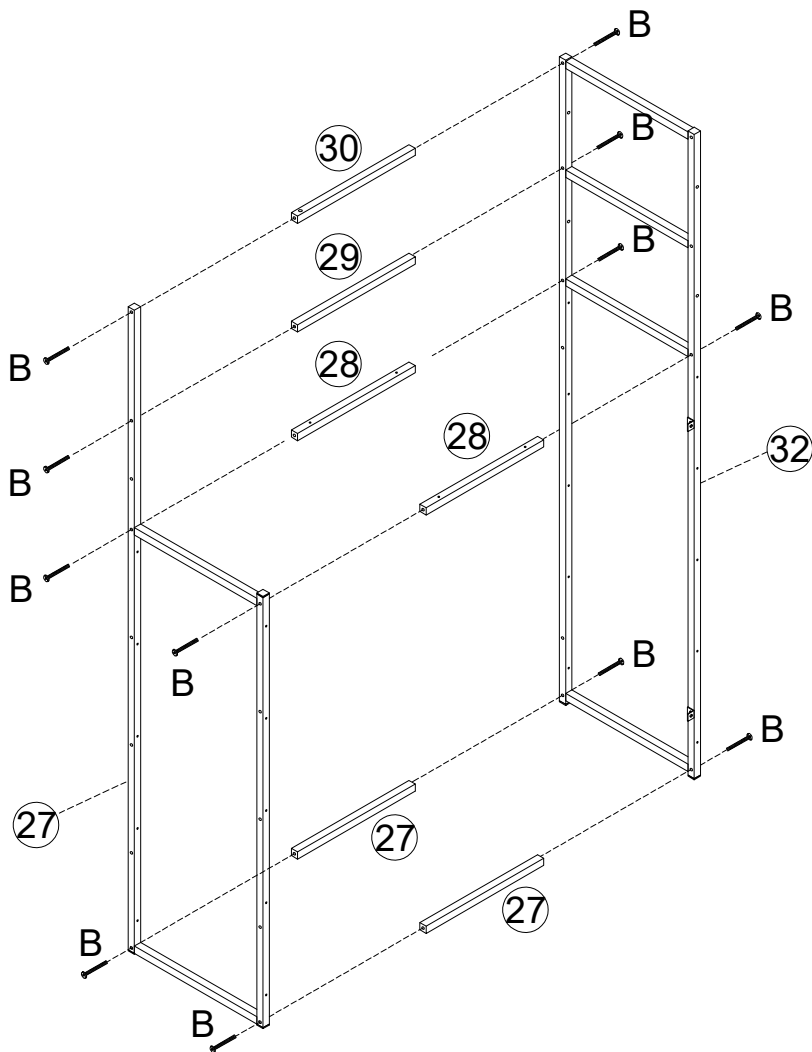

B
M $\frac{1}{4}$ "x35
12 PCS

STEP 7

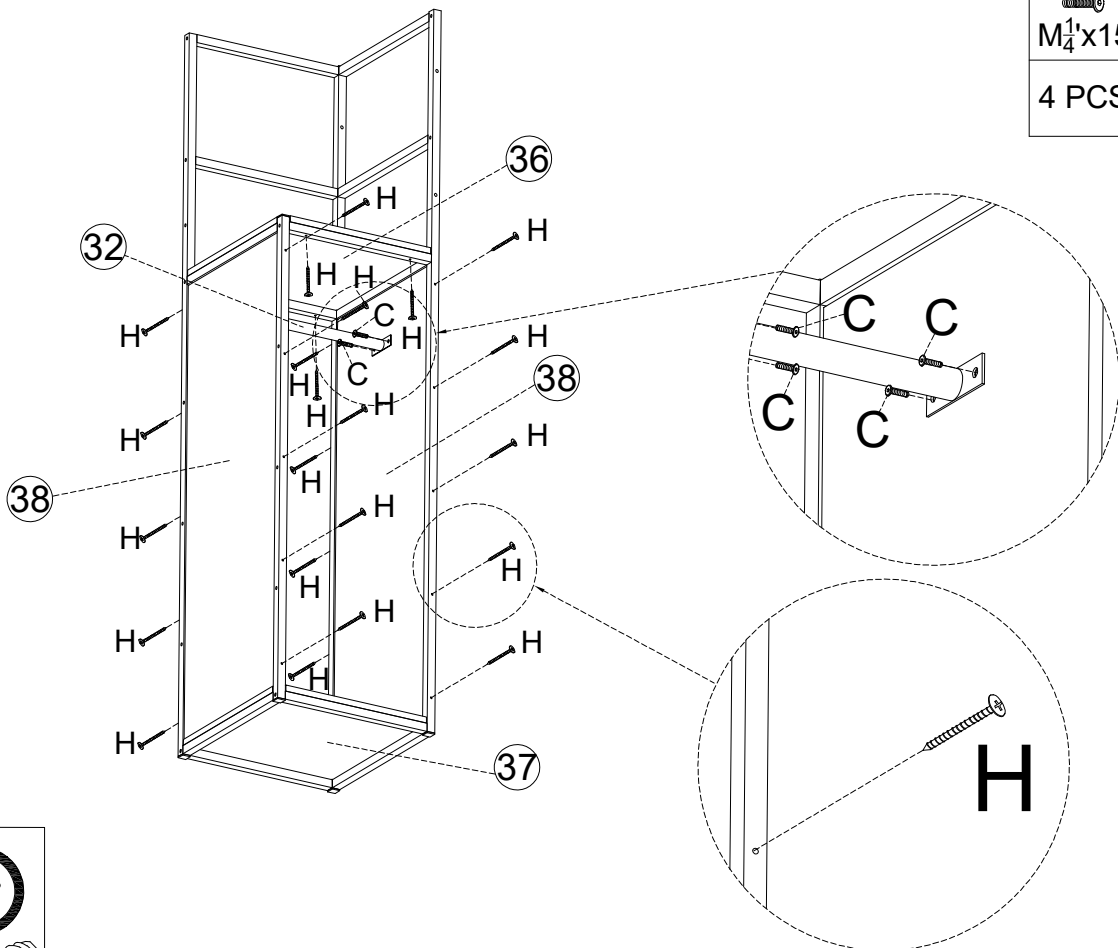

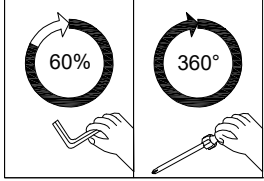

C	H
M $\frac{1}{4}$ "x15	M4x30
4 PCS	24 PCS

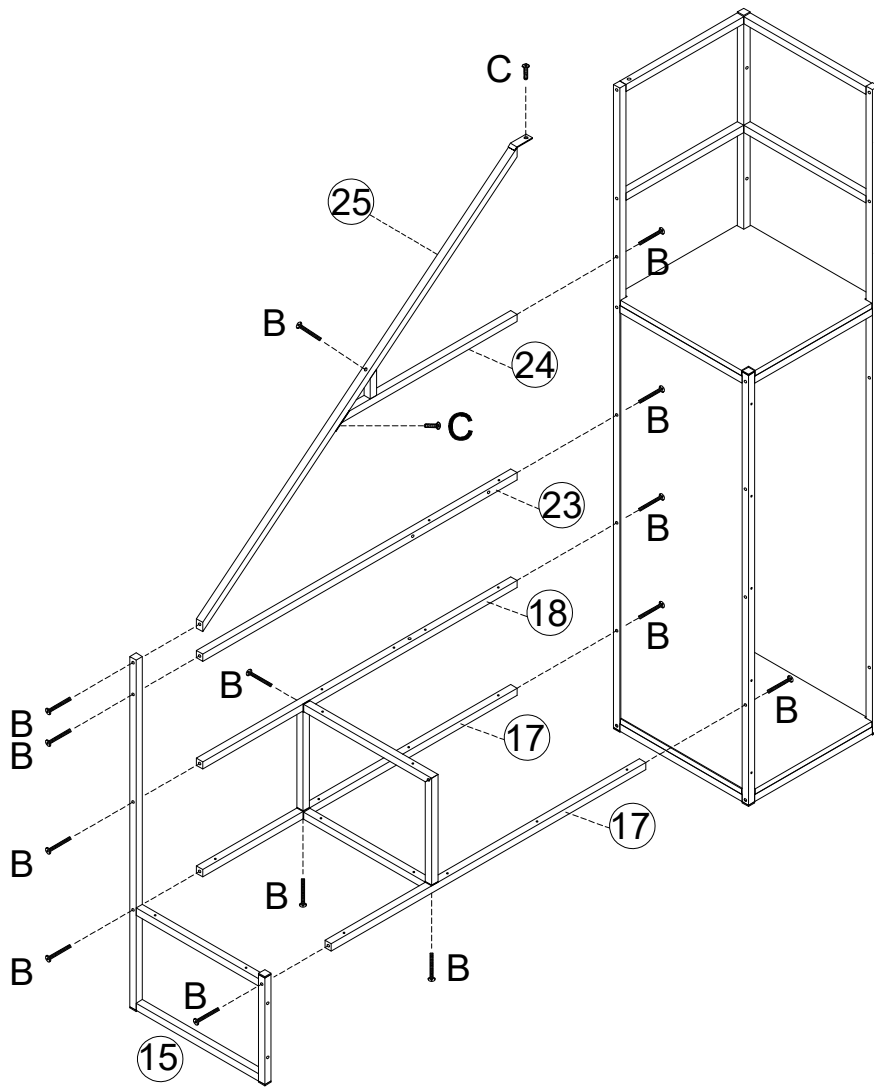

STEP 8



B	C
 M $\frac{1}{4}$ "x35	 M $\frac{1}{4}$ "x15
14 PCS	2 PCS

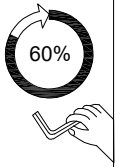



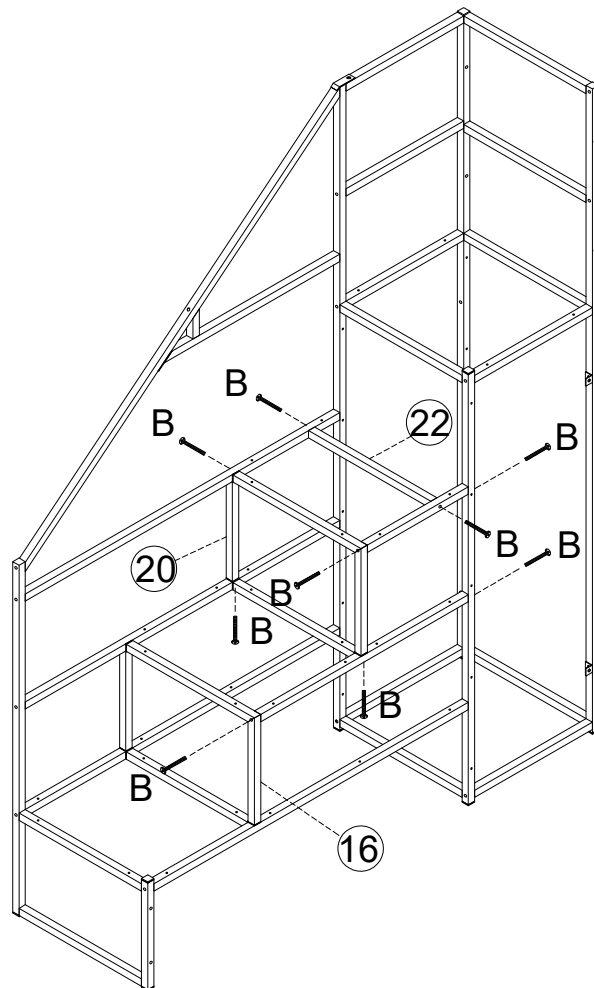

STEP 9

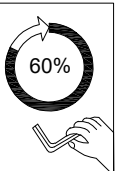

B
 M $\frac{1}{4}$ "x35
9 PCS



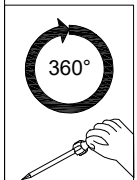
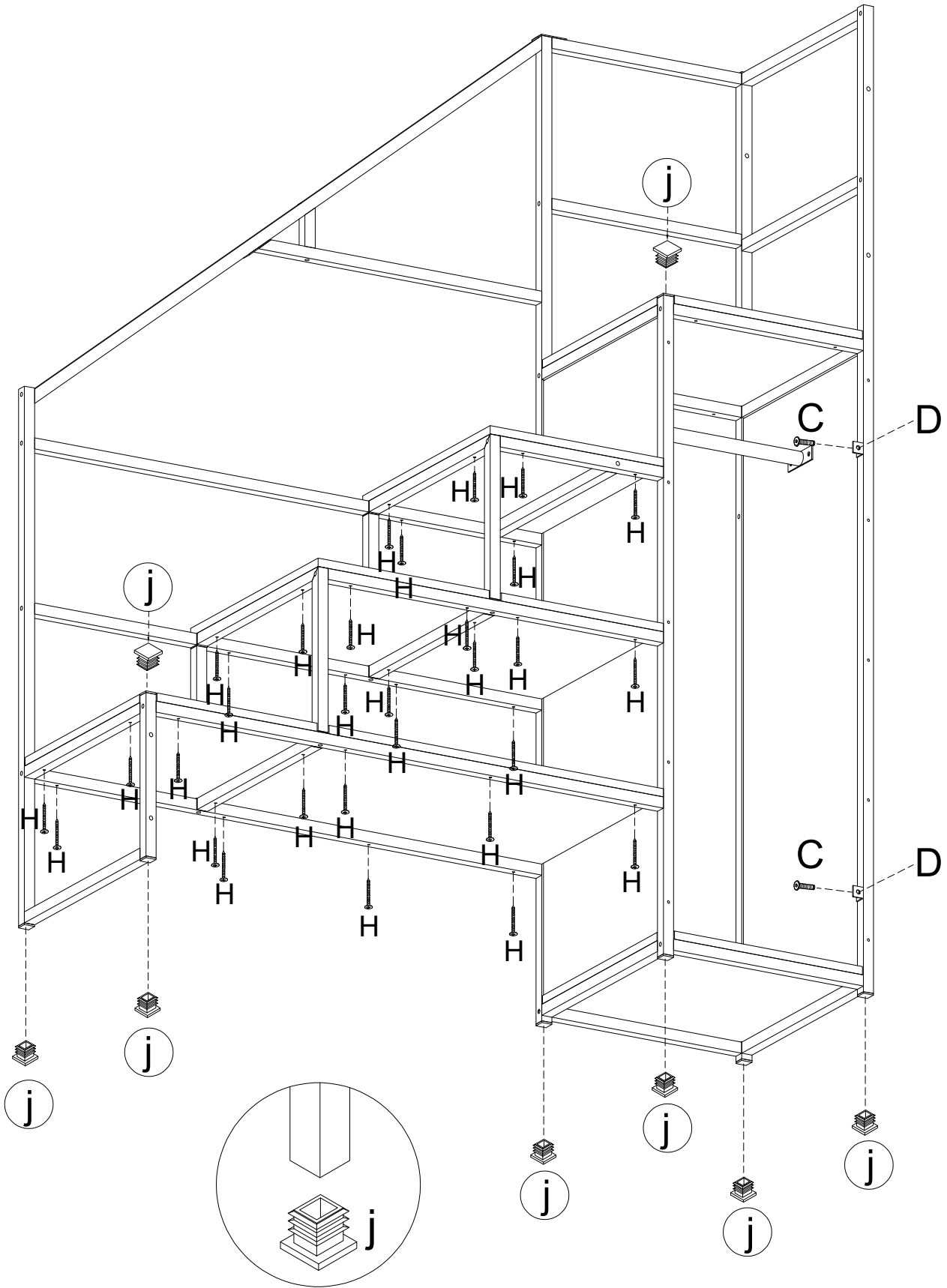

STEP 10

C	H	D	j
 M $\frac{1}{4}$ "x15	 M4x30	 20x20	 #20x20x13
2 PCS	30 PCS	2 PCS	8 PCS



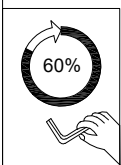
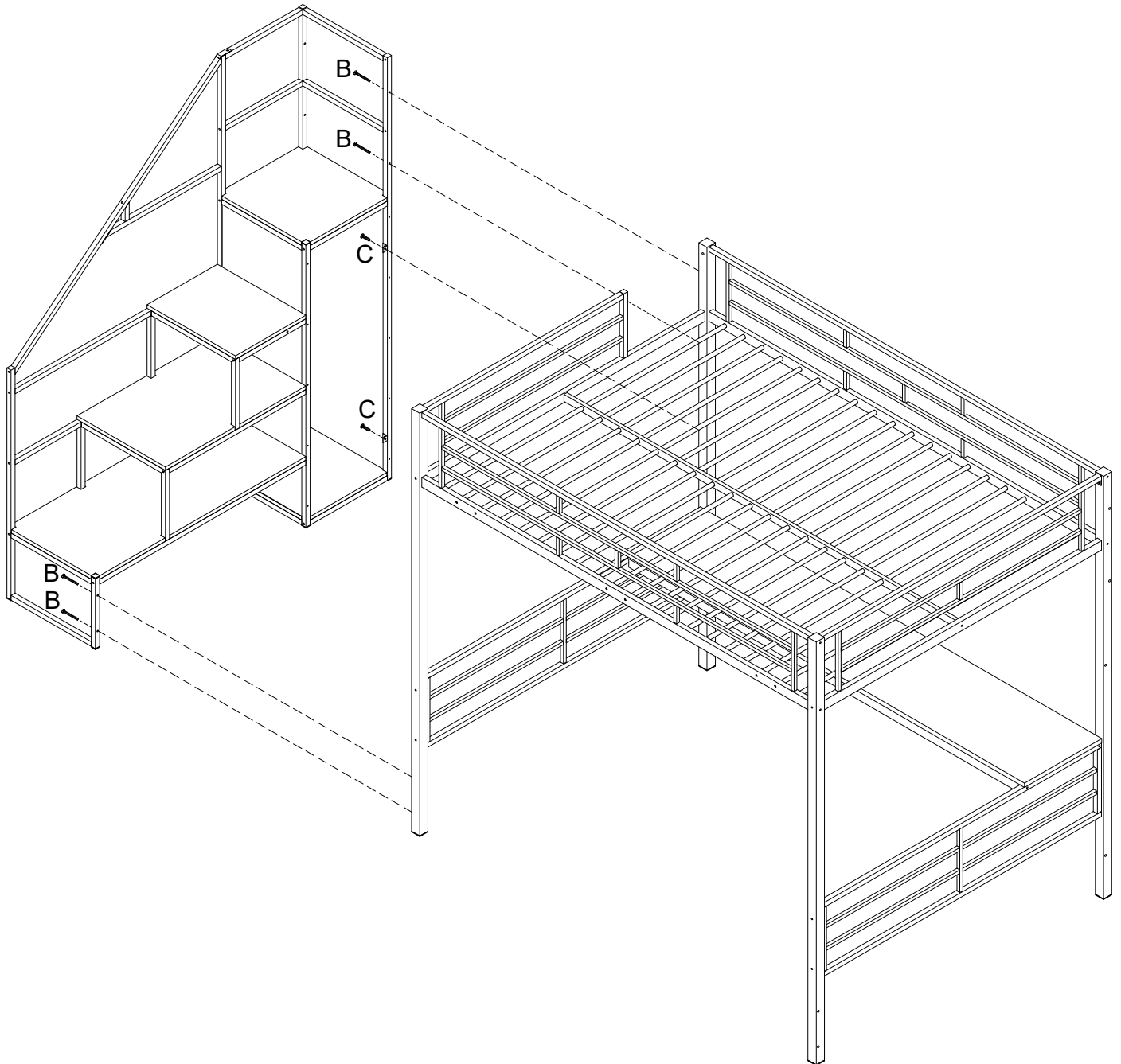

STEP 11

B	C
	
M $\frac{1}{4}$ "x35	M $\frac{1}{4}$ "x15
4 PCS	2 PCS



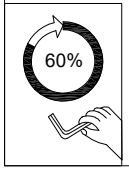
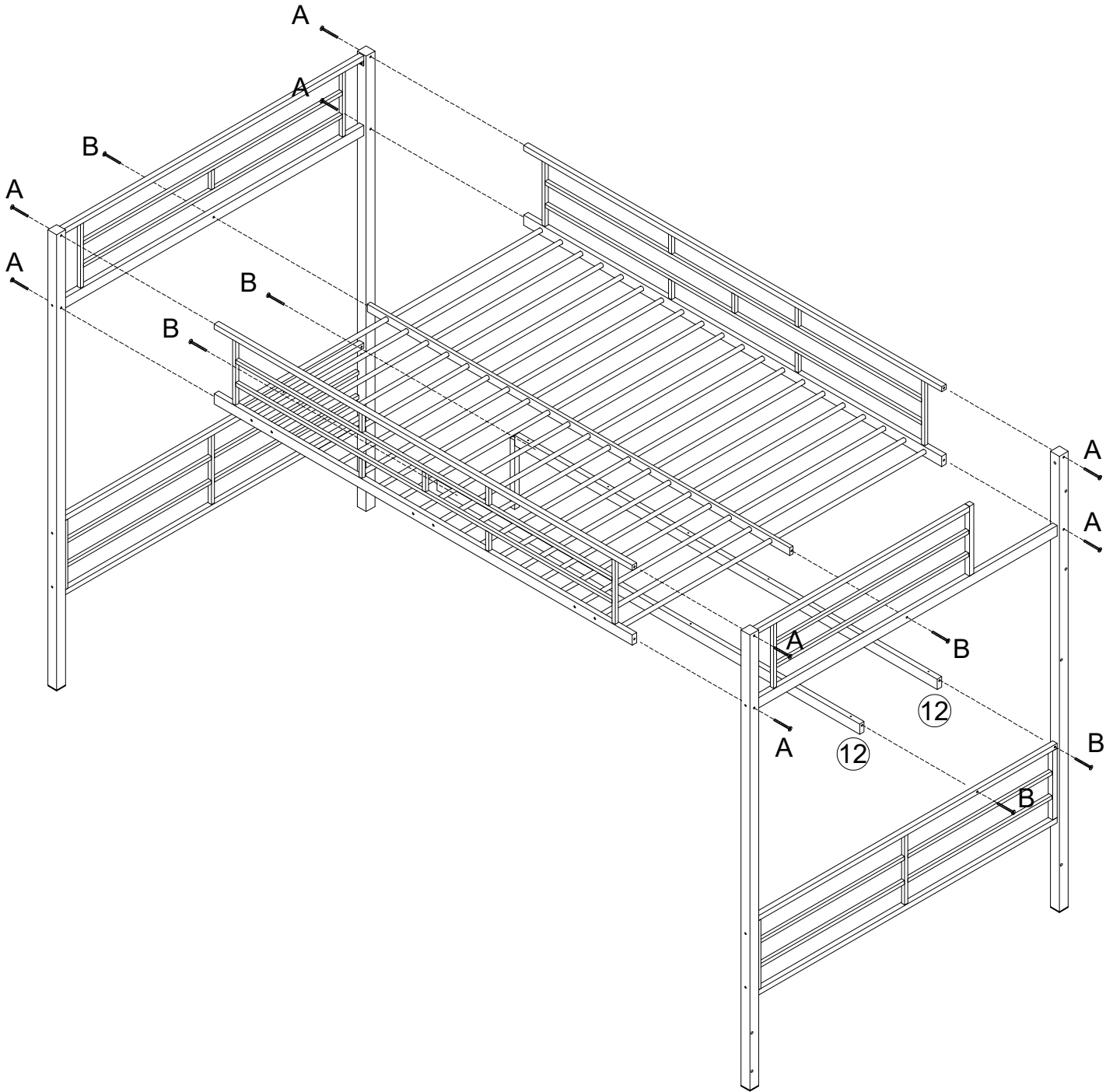

STEP 4

A	B
 M $\frac{1}{4}$ "x50	 M $\frac{1}{4}$ "x35
8 PCS	6 PCS



STEP 11

B	C
 M $\frac{1}{4}$ "x35	 M $\frac{1}{4}$ "x15
4 PCS	2 PCS

