

Chicken Coop

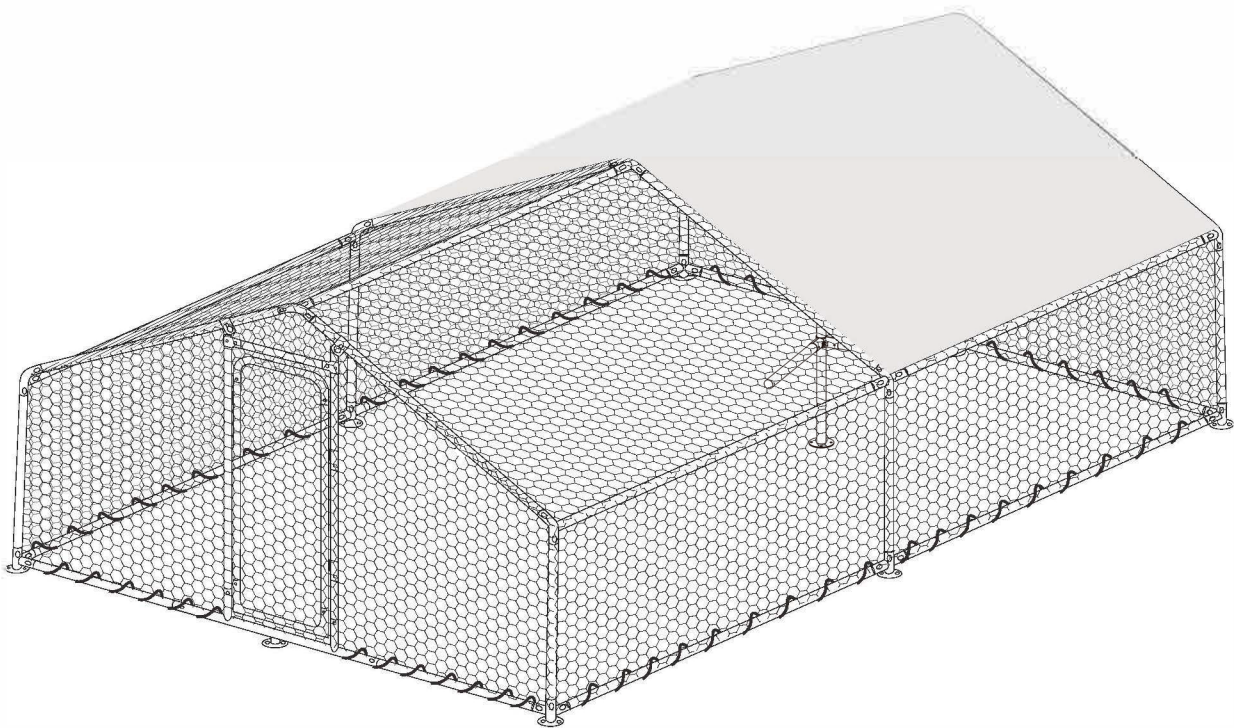



Thank you for shopping from us!

In order to enable you to better install or use this product, please carefully read the precautions and detailed functional operation instructions mentioned in this manual before using this product formally.













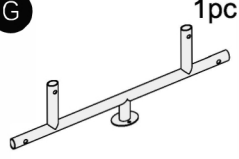





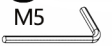
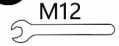



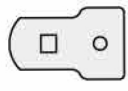





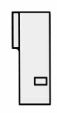
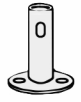





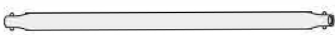

Hope you will have a good experience!

Assembly Guide

This assembly guide includes the Part List, Installation Steps and Warning Tips.

The item may be shipped into shipped in one boxes to facilitate transportation, and please understand that sometimes the packages may not arrive at the same time. Please check your package once you receive it. If any questions or issues with your item, please email us

Parts list

D 5pcs 	E 4 pcs 	F 3pcs 	G 1pc 
H 3pcs 	I 2pcs 	J 2pcs 	K 1pc 
L₁ M14 1pc  L₃ 1pc M5  L₂ 1pc M12 	L M6 2pcs  M 2pcs 	N 1pc 	O 5pcs 
P 4pcs  Q 1pc Roof 	R 18pcs 	S 250pcs  T 18pcs 	U 2pcs 
V 1pc 	W 2pcs M8 	X 1pc 	Y 1pc  Z 4 pcs M10  hexagonal wire netting 1pc  SIZE: 78.74" x 787.4"
 1 10pcs 73.82 inch pipe	 7 1pc 72.24 inch pipe		
 2 6pcs 62.4 inch pipe	 8 2pcs 53.93 inch pipe		
 3 6pcs 38.19 inch pipe	 9 1pcs 72.24 inch pipe		
 4 2pcs 41.73 inch pipe	 10 1pc 66.34 inch pipe		
 5 1pc 66.34 inch pipe	 A 1pcs 23.23 inch pipe		
 6 1pc 23.62 inch pipe	 have hole B 2pcs 57.09 inch pipe  C 1pc 19.49 inch pipe		

Installation Steps

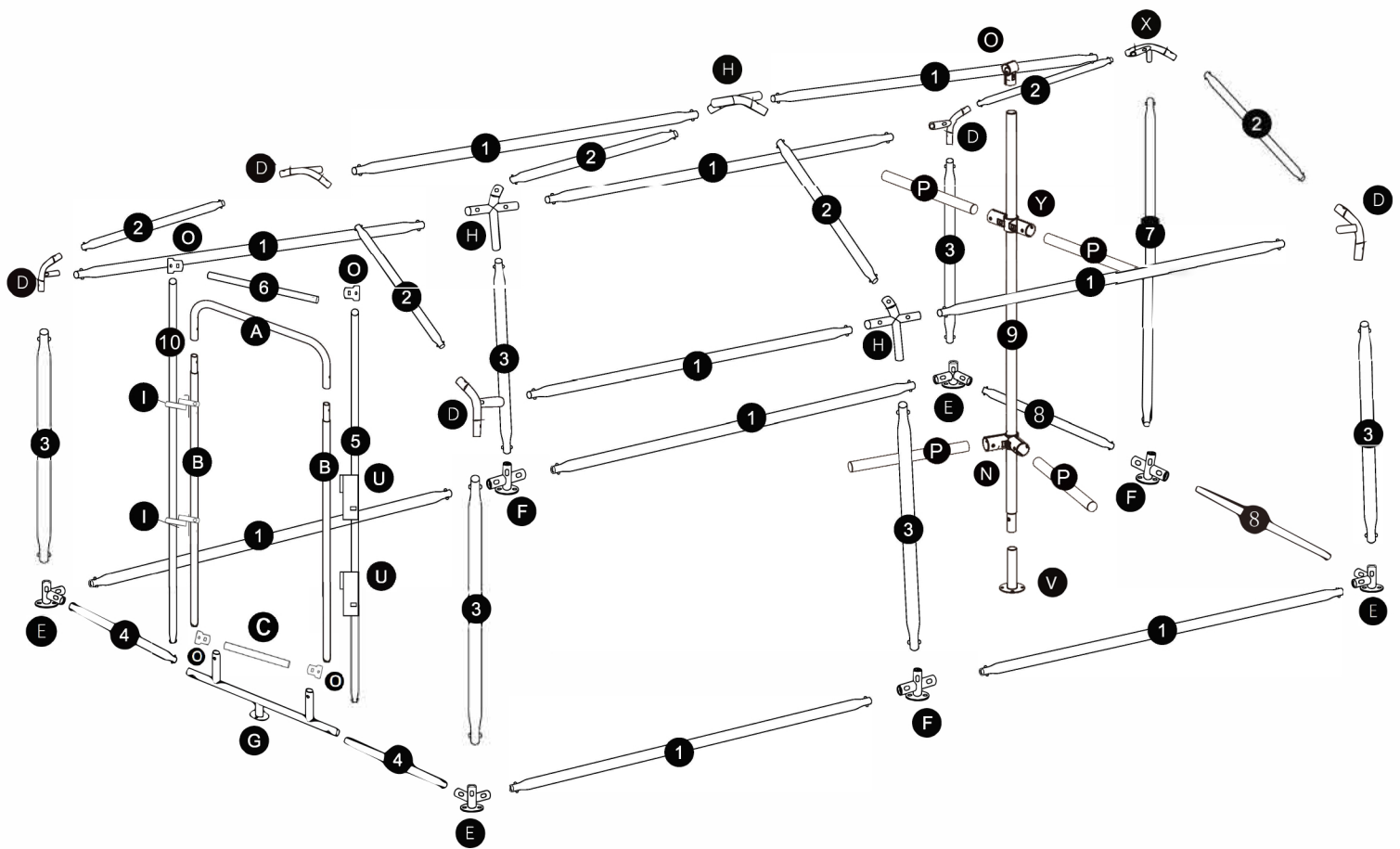





Checking

Check if there is any part missing or damaged.

Ensure the parts and quantities in parcel are accordance with Part List. If any mistakes, please kindly contact us through the purchase platform.

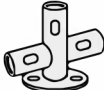
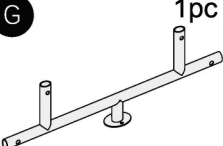
Assembly

Step 1

E  4pcs	F  3pcs	G  1pc	 1 4pcs
			 8 2pcs
			 4 2pcs

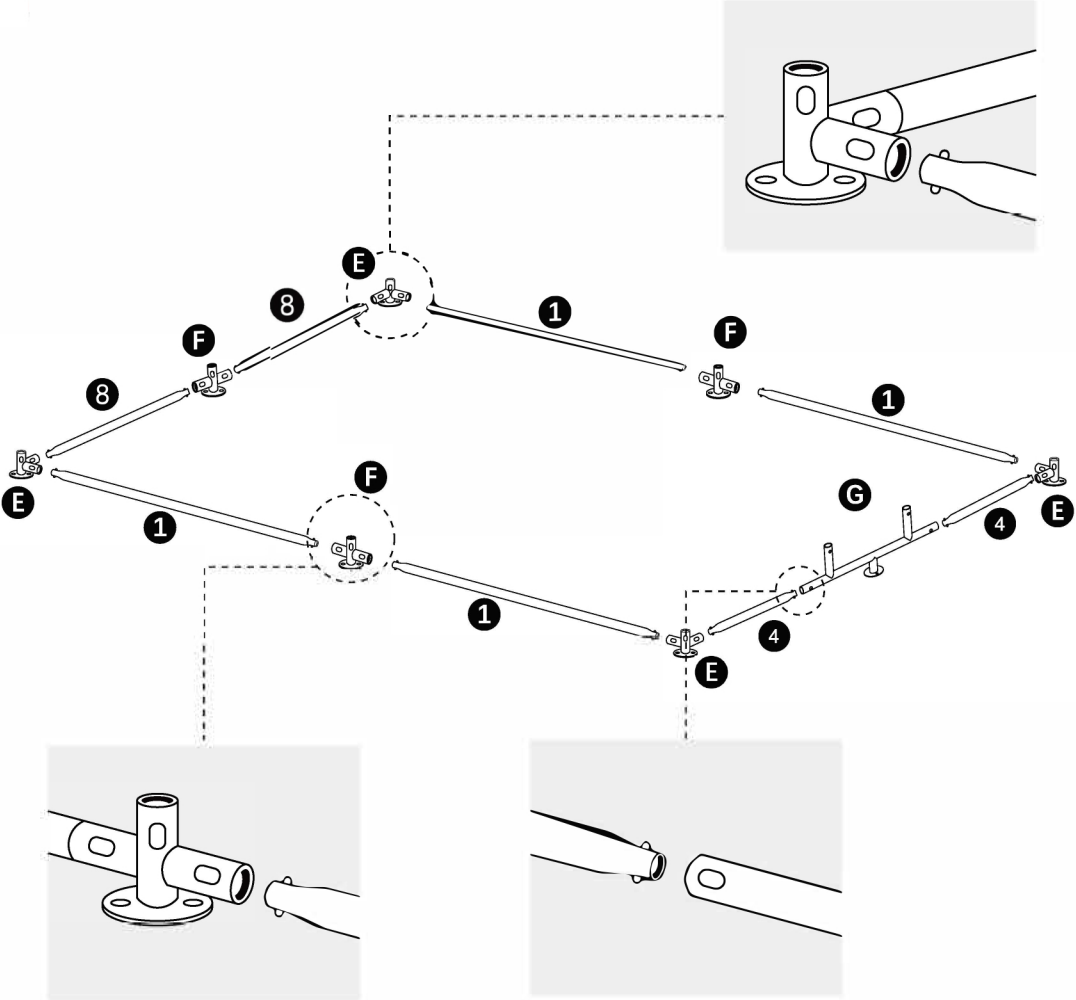

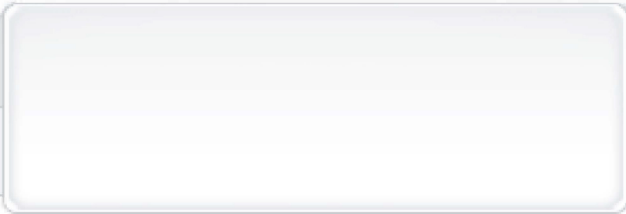

Step 2

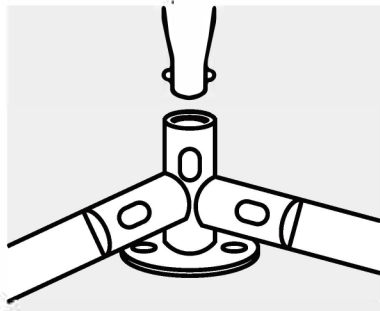
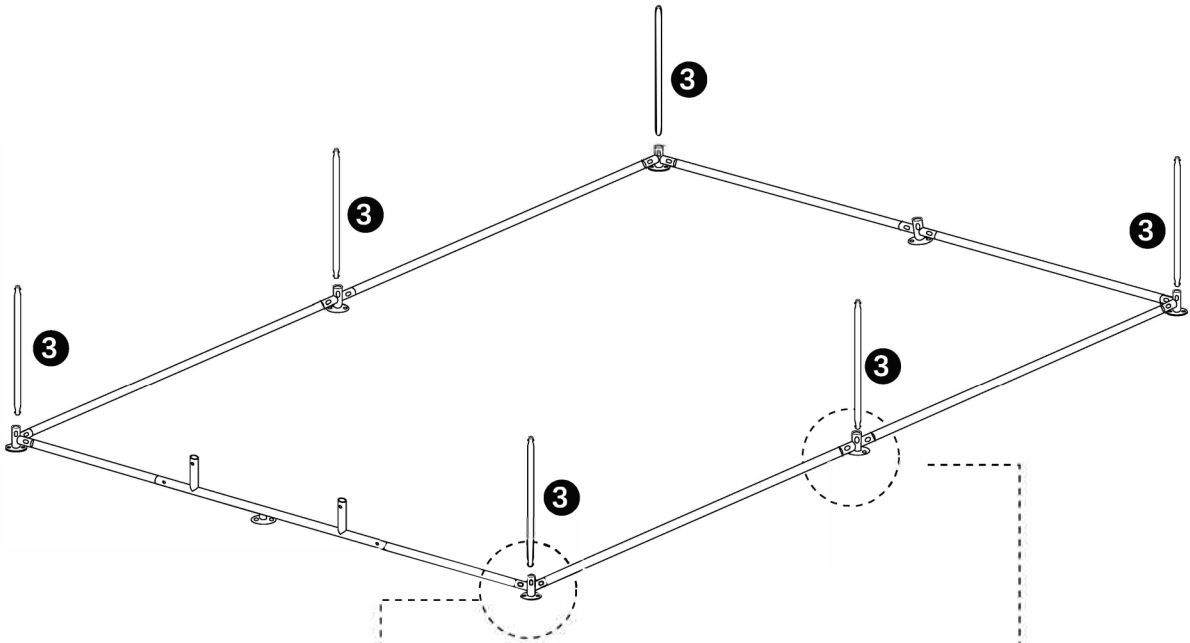
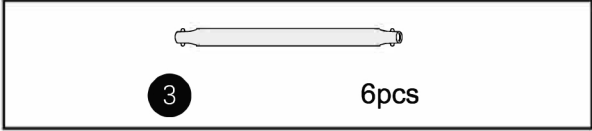

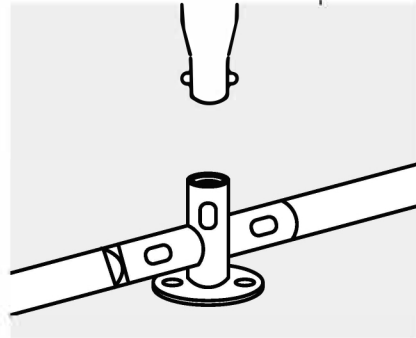

Put # 3 and E together

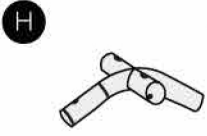
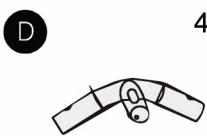

Put # 3 and F together

Step 3



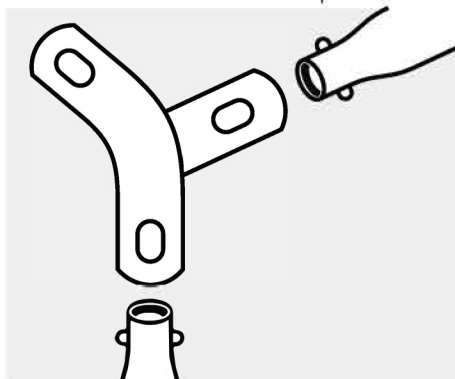
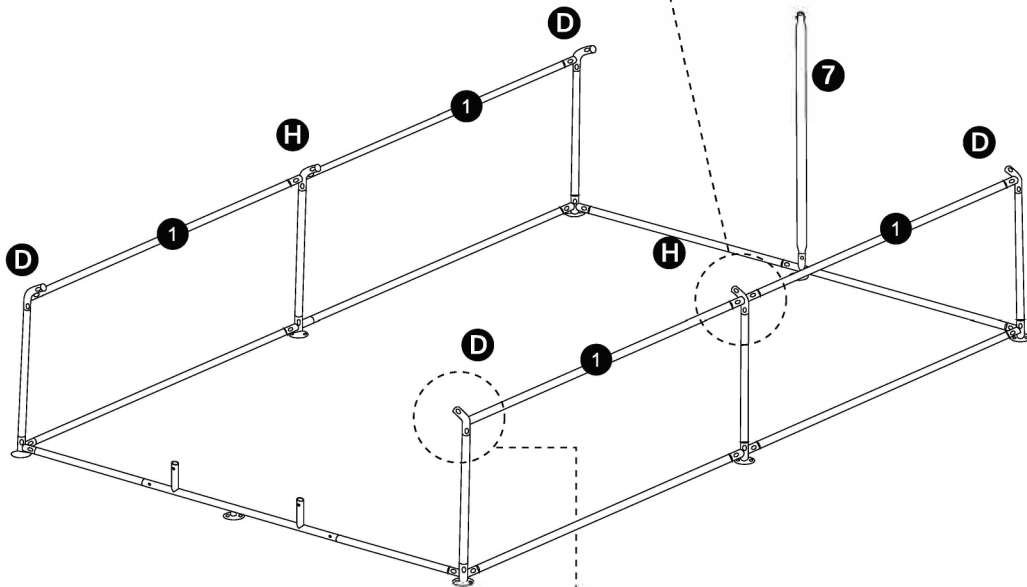
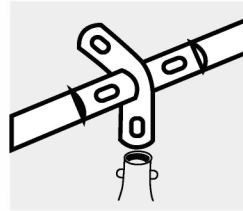

 <p>H 2pcs</p>	 <p>D 4pcs</p>	<p>1 4pcs</p> 
		<p>7 1pc</p> 

Put the H and # 3 together



Put the D and # 3 together

Step 4

<p>D 1pc</p> 	<p>X 1pc</p> 	<p>H 1pc</p> 	<p>2 6pcs</p>  <p>1 2pcs</p> 
------------------------------------------------------------------------------------------------------	-------------------------------------------------------------------------------------------------------	-------------------------------------------------------------------------------------------------------	-------------------------------------------------------------------------------------------------------------------------------------------------------------------------------------------------------------------

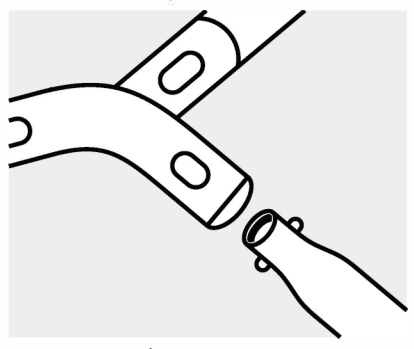
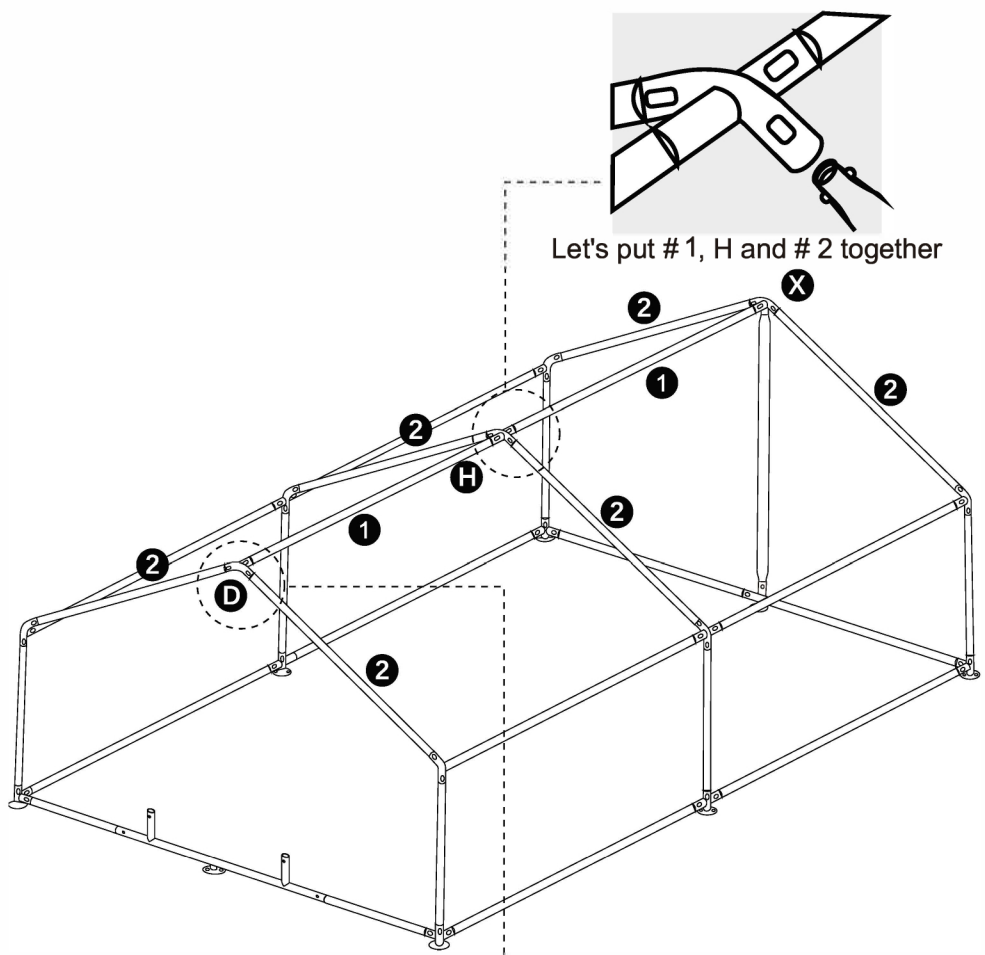



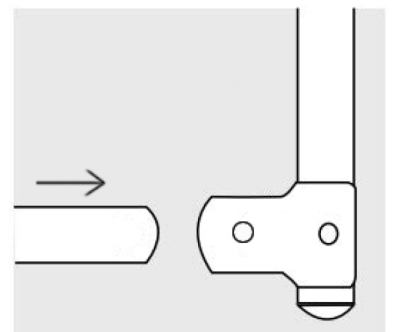
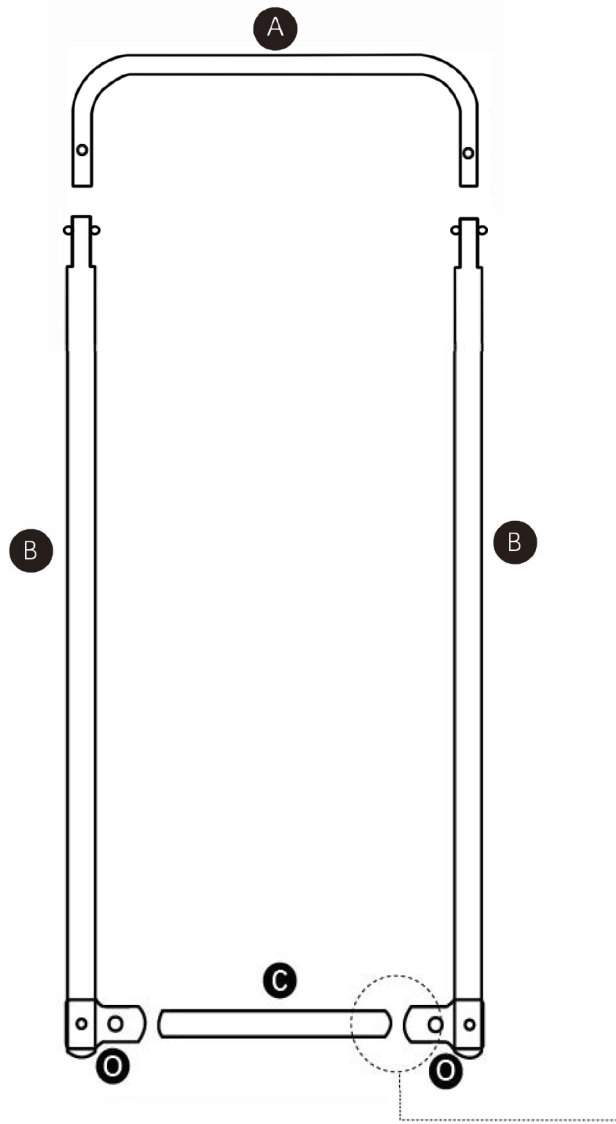
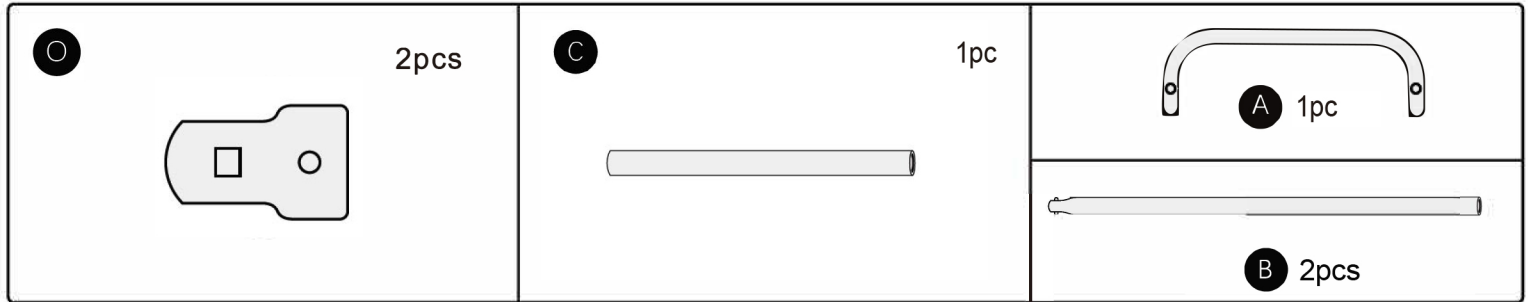





Step 5



Put the O and C together

Step 6

 2pcs 	 1pc 	 1pc 	 1pc 
-----------------------------------------------------------------------------------------------------------------------------------------------------------------------------	----------------------------------------------------------------------------------------------------------------------------------------------------------------------------	-----------------------------------------------------------------------------------------------------------------------------------------------------------------------------	--------------------------------------------------------------------------------------------------------------------------------------------------------------------------------

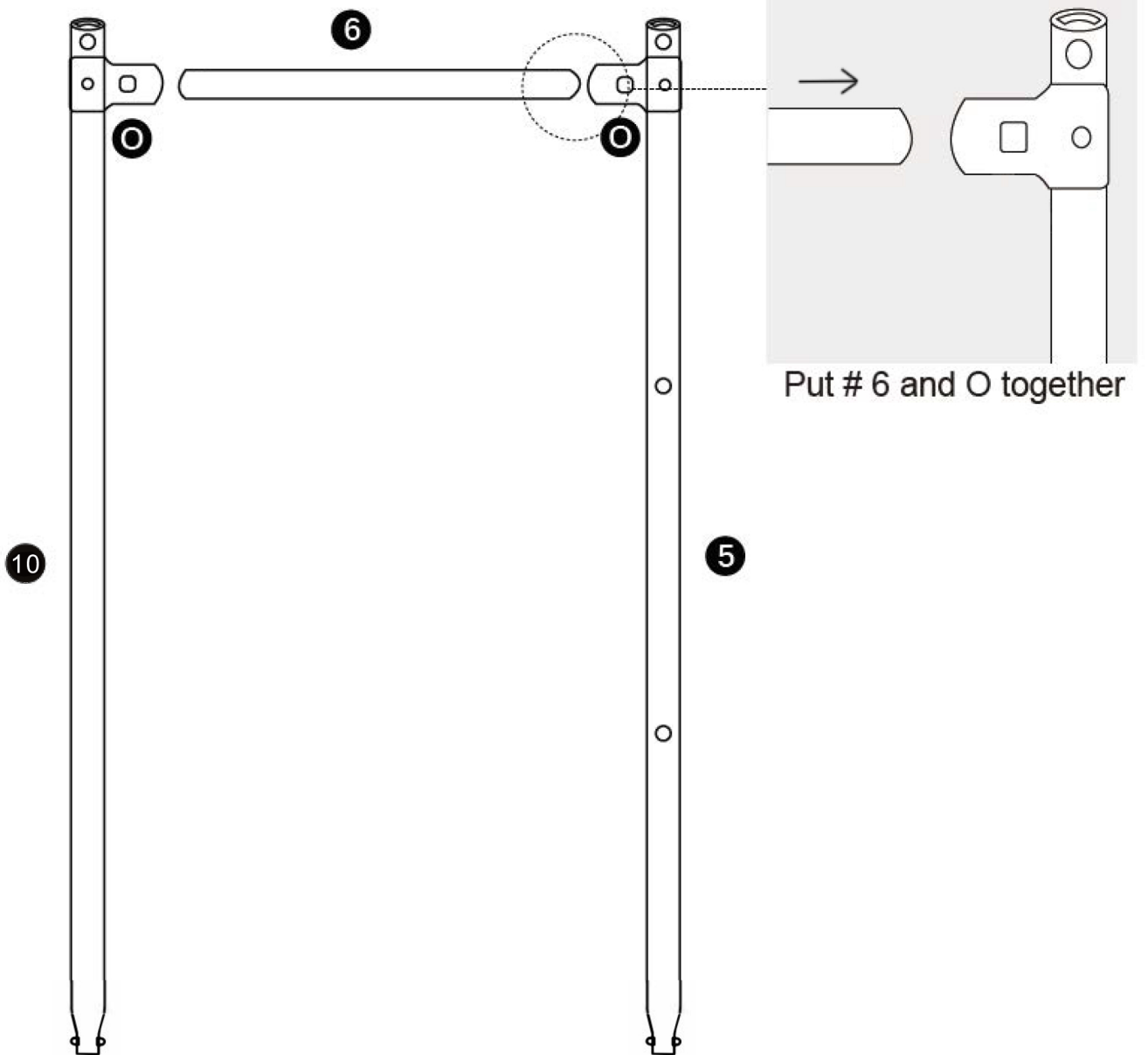

Step 7

<p>I 2pcs</p> 	<p>U 2pcs</p> 	<p>W 2pcs M8</p> 	<p>Z 4pcs M10</p> 
--------------------------------------------------------------------------------------------------------	--------------------------------------------------------------------------------------------------------	----------------------------------------------------------------------------------------------------------------	------------------------------------------------------------------------------------------------------------------

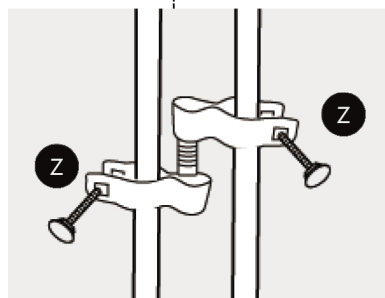
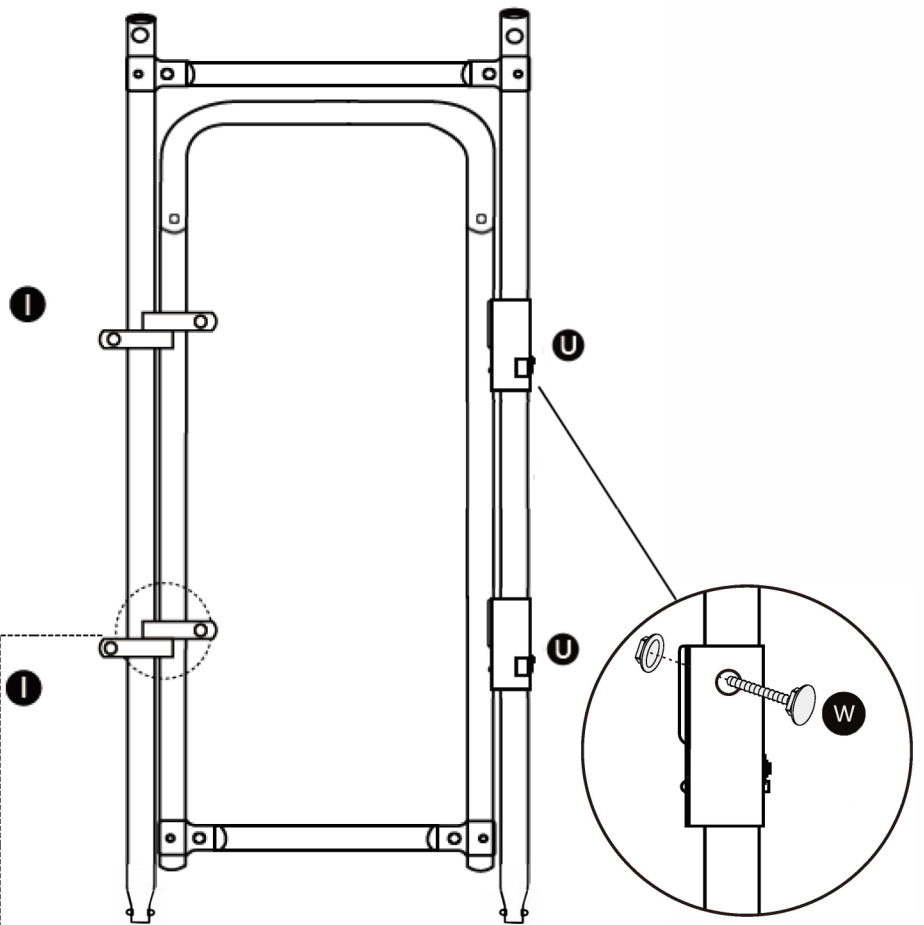



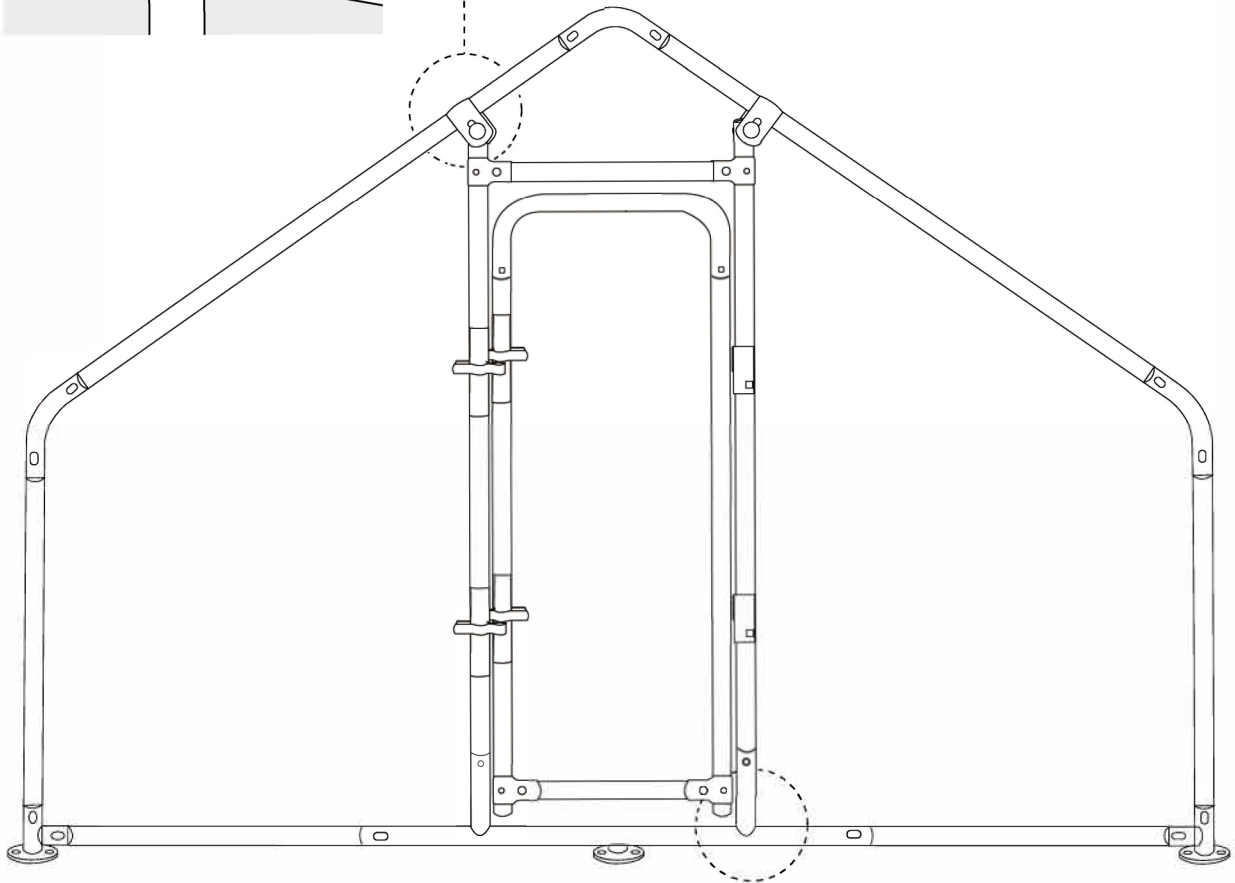
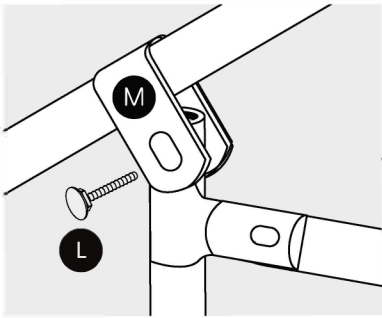
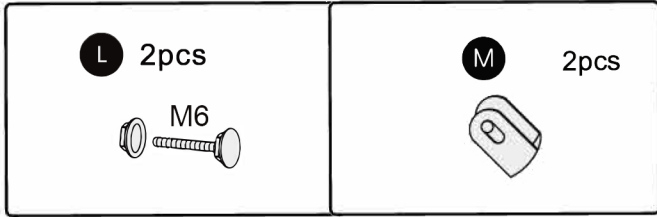

Put the I together

Step 8

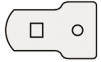

Step 9

 1pc		 1pc	
 1pc			

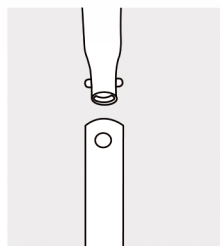
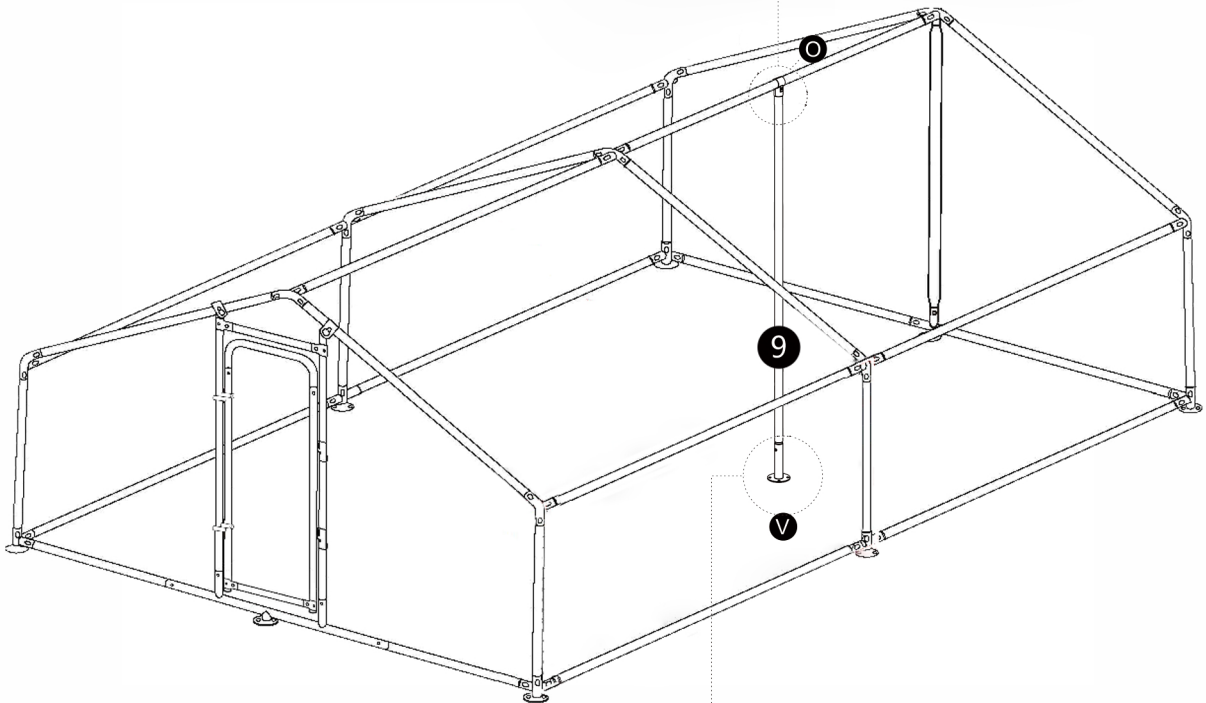
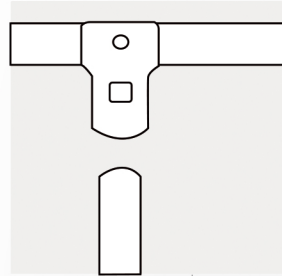

Step 10

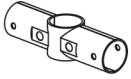
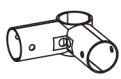
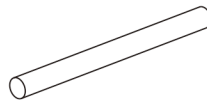
<p>Y</p>  <p>1pc</p>	<p>N</p>  <p>1pc</p>	<p>P</p>  <p>4pcs</p>
-------------------------------------------------------------------------------------------------------	-------------------------------------------------------------------------------------------------------	----------------------------------------------------------------------------------------------------------

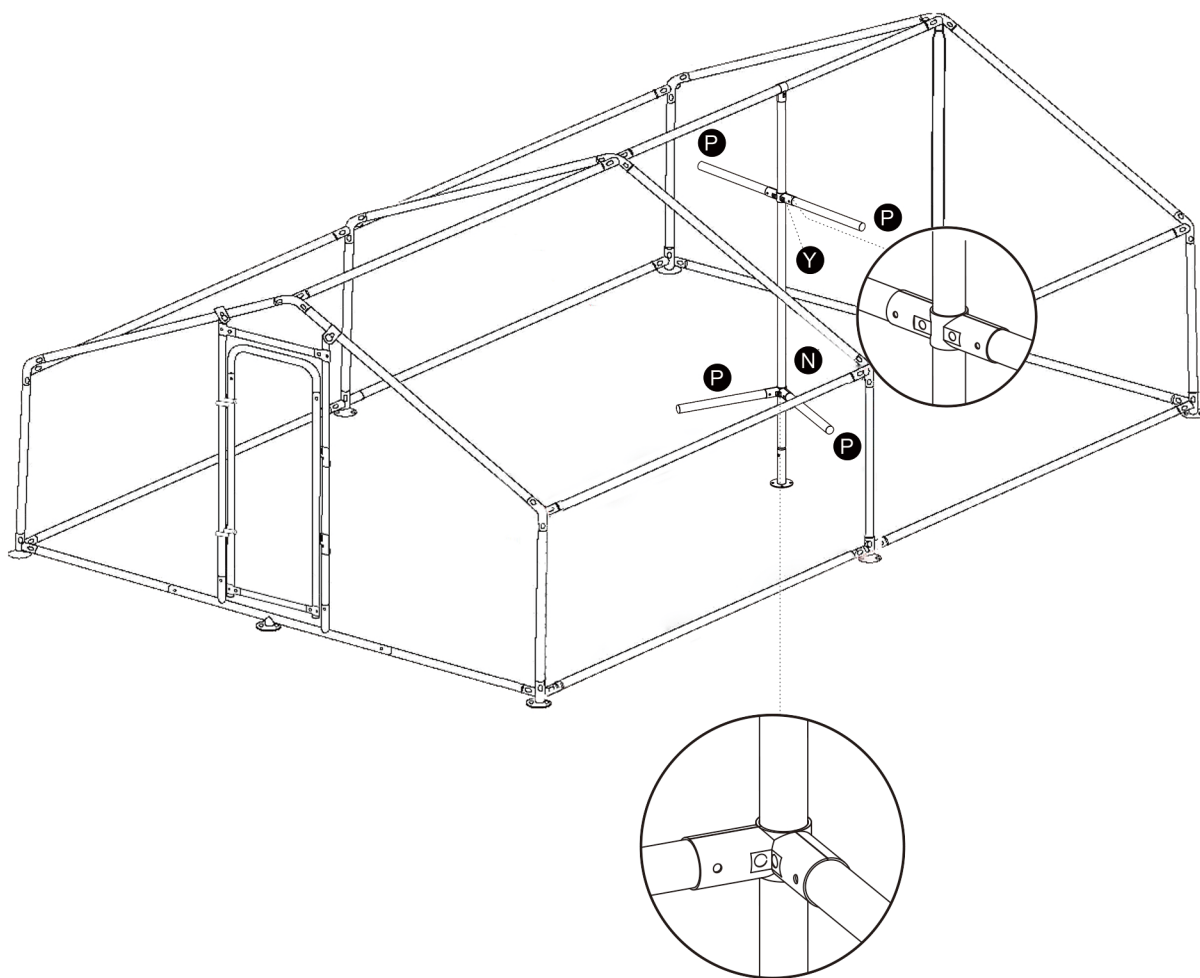

Step 11

hexagonal wire netting 1PC
SIZE: 787.4" x 78.7"

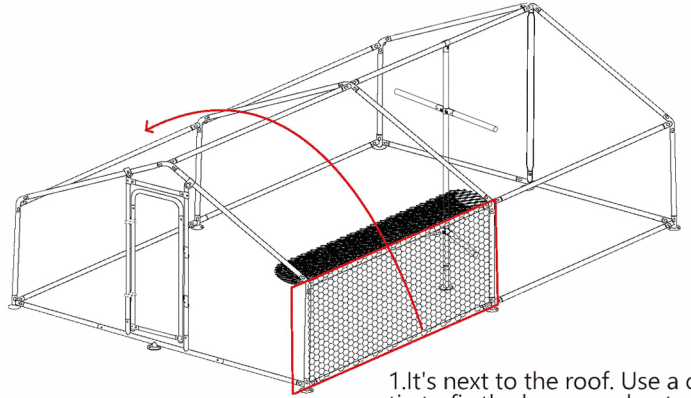
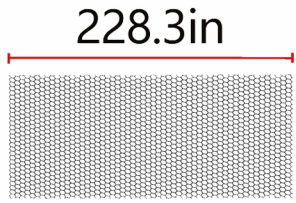

1. It's next to the roof. Use a cable tie to fix the hexagonal net on one side of the coop and unfold it

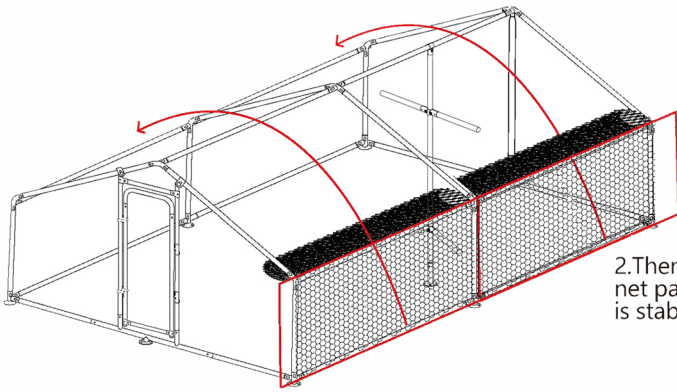

2. Then straighten the hexagonal net part, so that the chicken cage is stable

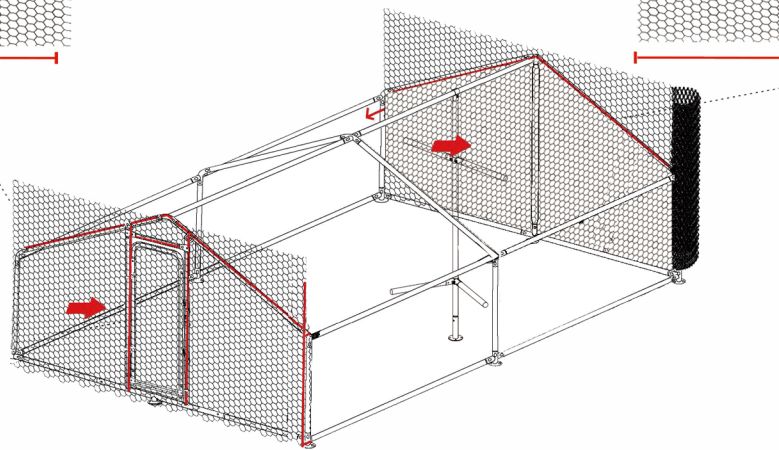
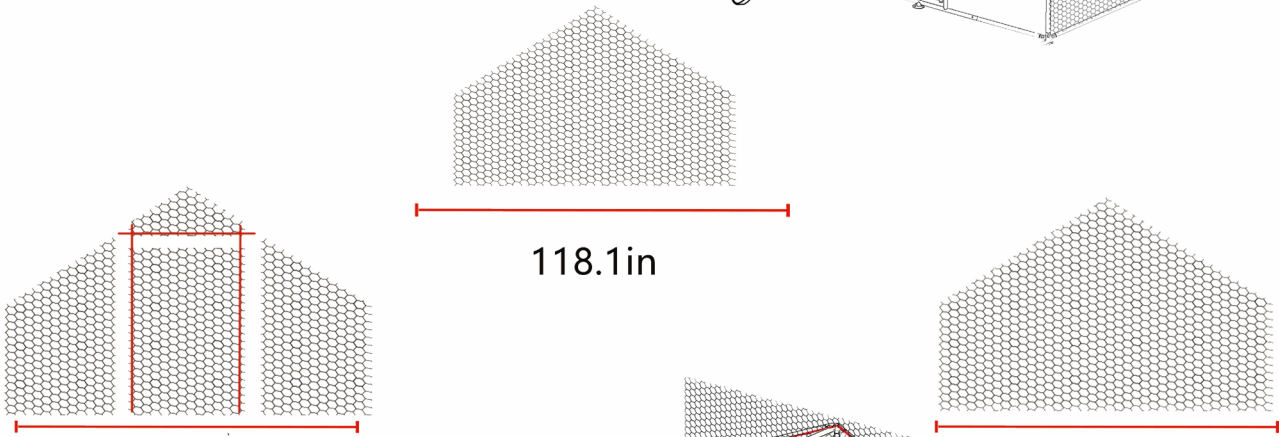
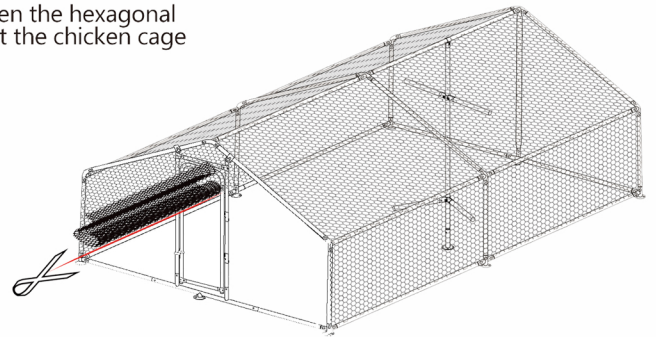

Step 12

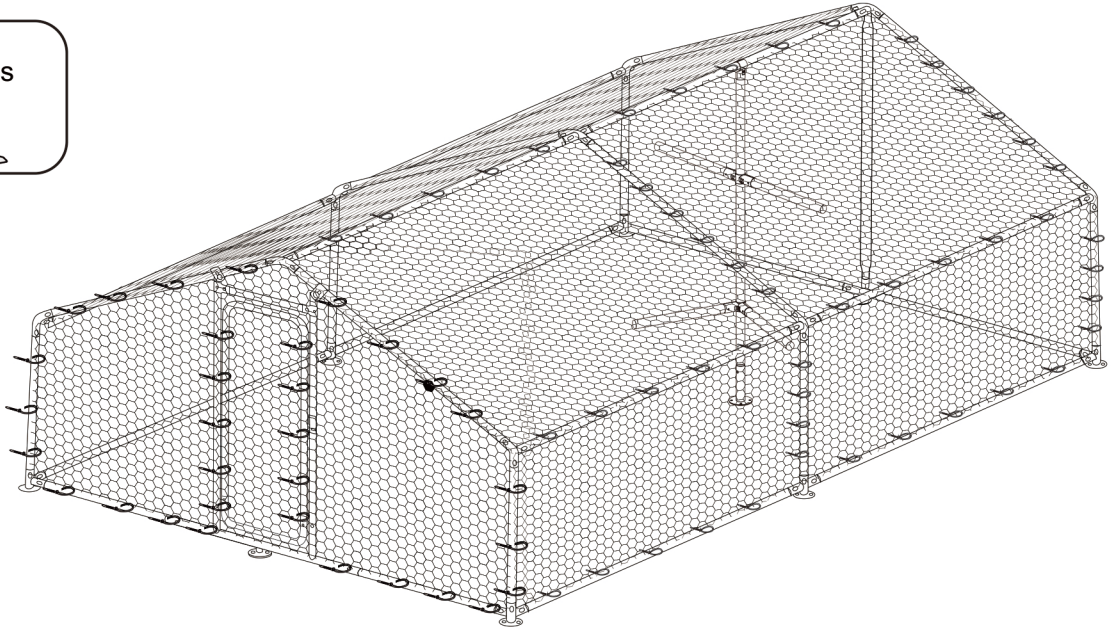
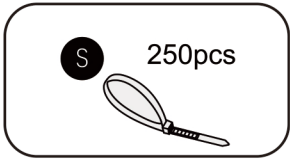

Secure all coop nets with cable ties

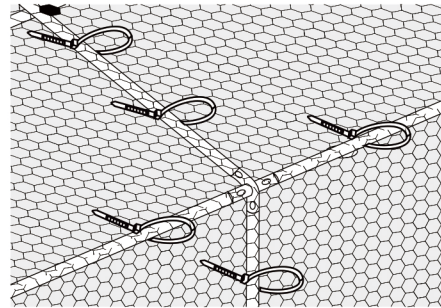

Lock the net cover to the coop via tie straps

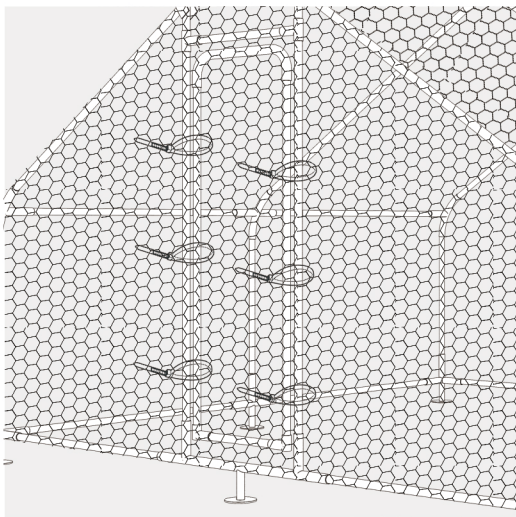



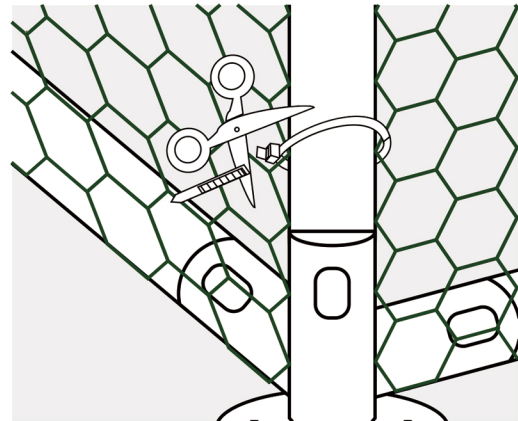

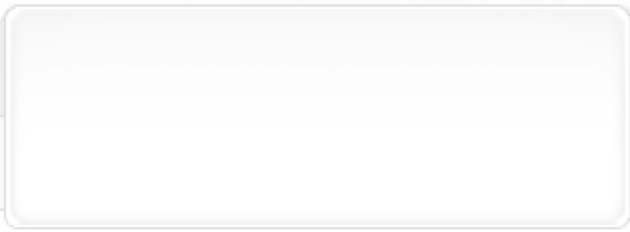
Secure the whole net cover was locked with tie straps





Step 13

 18pcs 	 1pc 
------------------------------------------------------------------------------------------------------------------------------------------------------------------------------	----------------------------------------------------------------------------------------------------------------------------------------------------------------------------

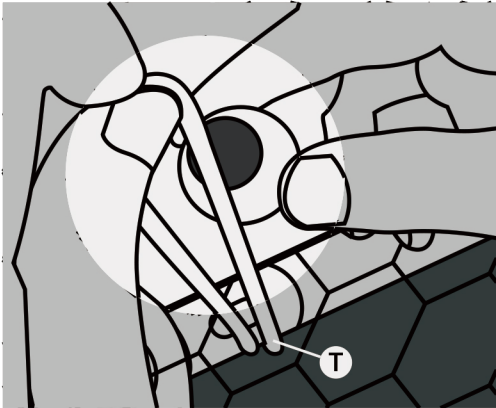
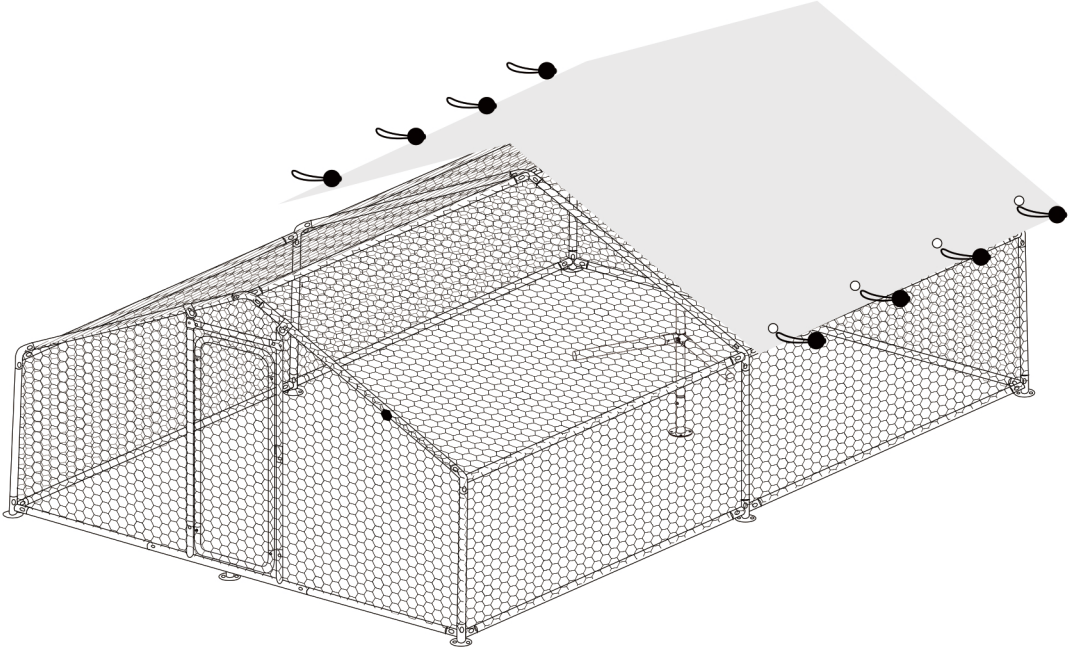

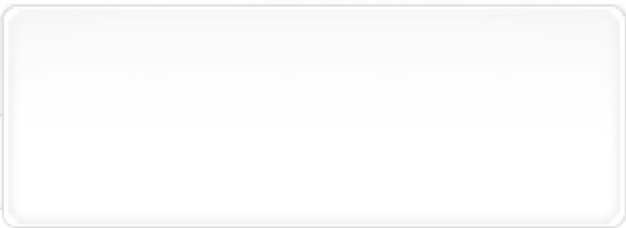

Step 14

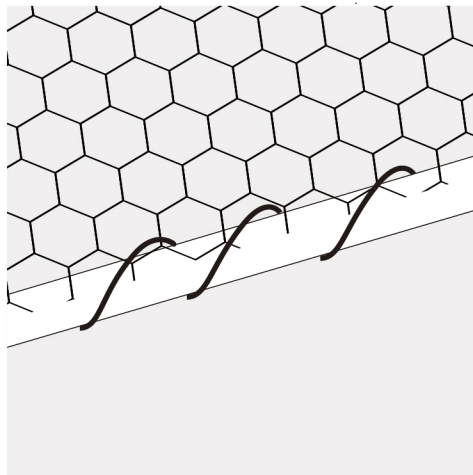
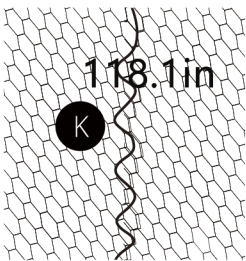
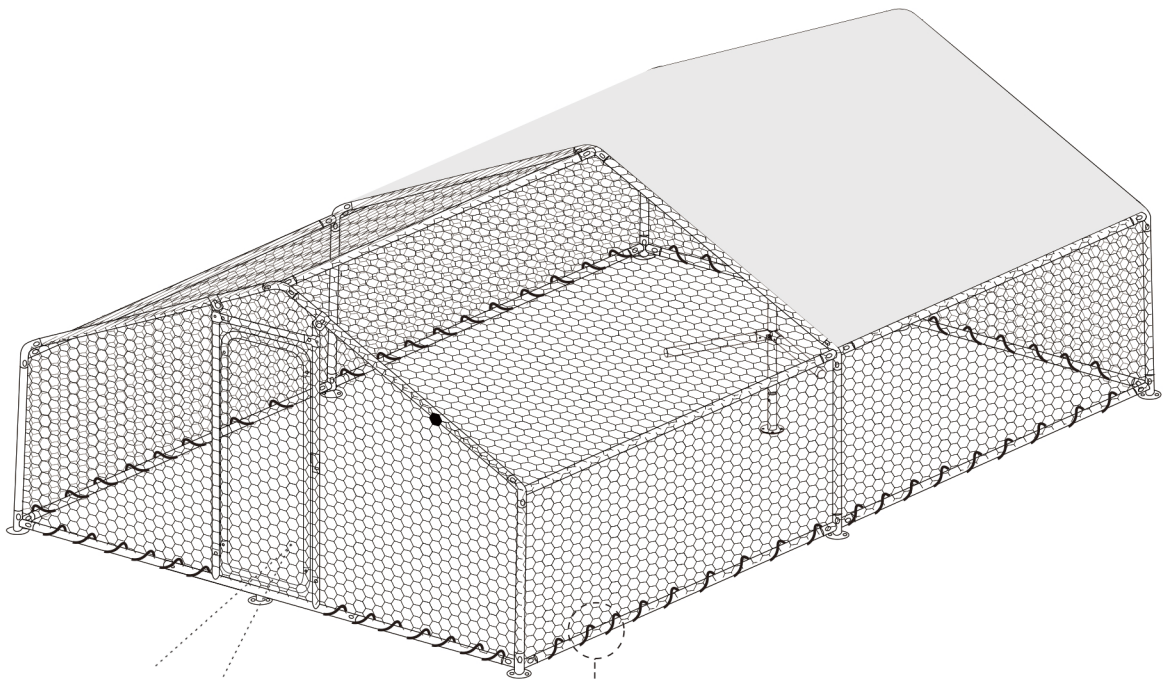
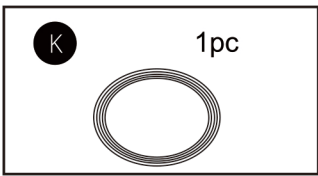

Step 15

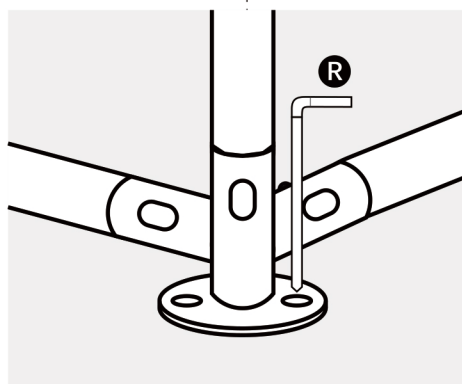
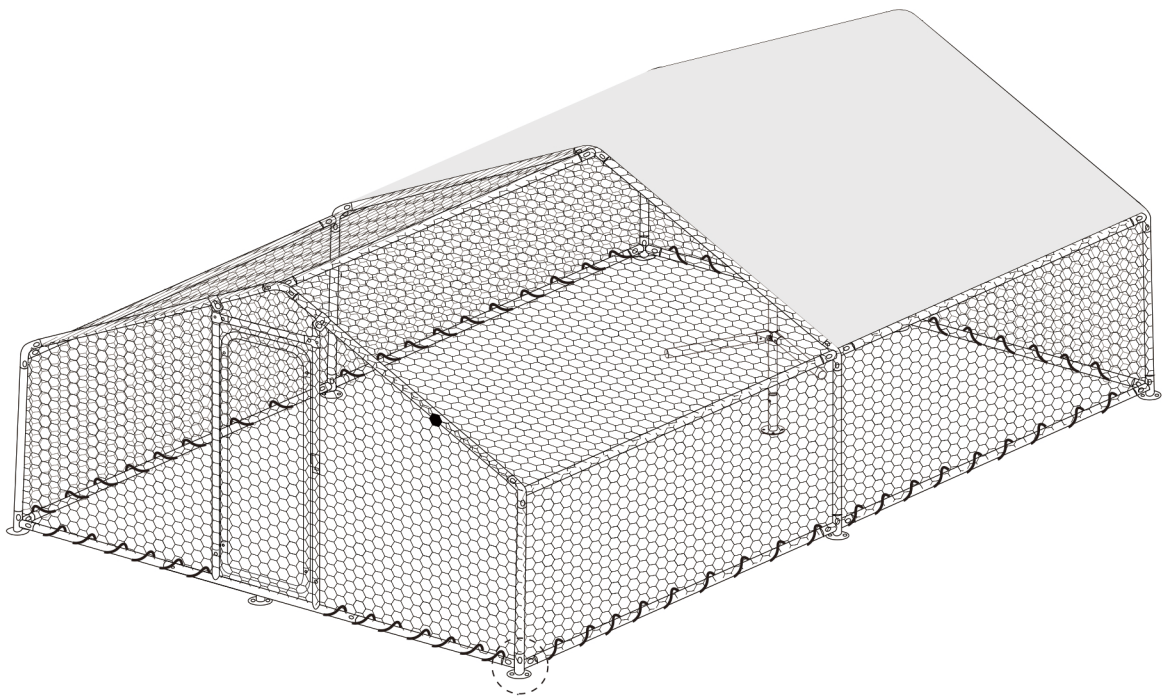
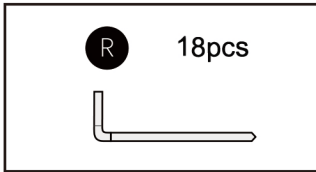

Security/ Notice

- Fasten screws loosely during initial assembly. Do not firmly tighten the screws until the item is completely assembled.
- Be aware that some parts are heavy and have sharp edges.
- If any parts are missing, broken, damaged, or worn, stop using this item until repairs are made and/or factory replacement parts are installed.
- Reconfirm that all bolts, screws, and knobs are secure every 90 days.
- Do not use this item in a way inconsistent with the manufacturer's instructions as this could void the product warranty.

Warranty Guidelines

- Warranty period is determined by date of shipment . for factory direct purchases or date of purchase from an authorized reseller. Please save a copy of your purchase receipt.
- If this product or any associated parts are found to be defective or missing at the time of receipt, \ will repair or replace, at its option, the defective parts at no charge to the original purchaser. Replacement parts or repaired parts shall be covered for the remainder of the Original Limited Warranty Period. All shipping costs will be the responsibility of the seller.
- Continuous free technical support is provided, including online diagnosis and troubleshooting to users' problems, and come up with solutions in time. In order to process your claim, please upload a copy of your receipt along with AT LEAST 2 photos of the issue/damaged parts. Otherwise, supplier reserves the right to refuse replacement parts or credit.
- If a warranty claim is made after 30 days after purchase for missing or defective parts, the consumer is responsible for costs of parts and shipping.
- reserves the right to the final explanation of above warranty policy. Please contact our Customer Service

What is not covered by this limited warranty?

- Item past the warranty.
- Products that has been subjected to abuse, overweight, accident, alteration, modification, tampering, vandalism, negligence, misuse, abrasive contact, faulty installation or lack of reasonable care.

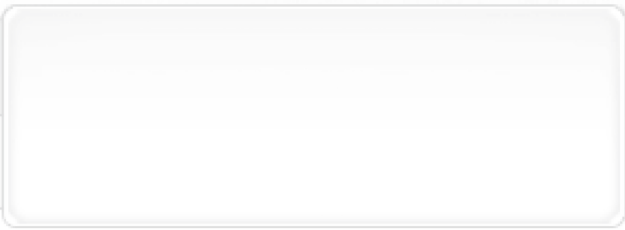

- Damage to the contents of products, any person or property is excluded. Normal and foreseeable service wear or tear.
- Parts damaged due to improper installation or assembly.
- Damage that occurs due to acts of nature, i.e. hurricane, tornado, wind, flood, snow, wind driven debris, etc.
- Third party labor or installation fees of any kind are not recoverable under the warranty.
- Other circumstances stipulated by law.