

---

# INSTRUCTION MANUAL

## Creative Fan Light

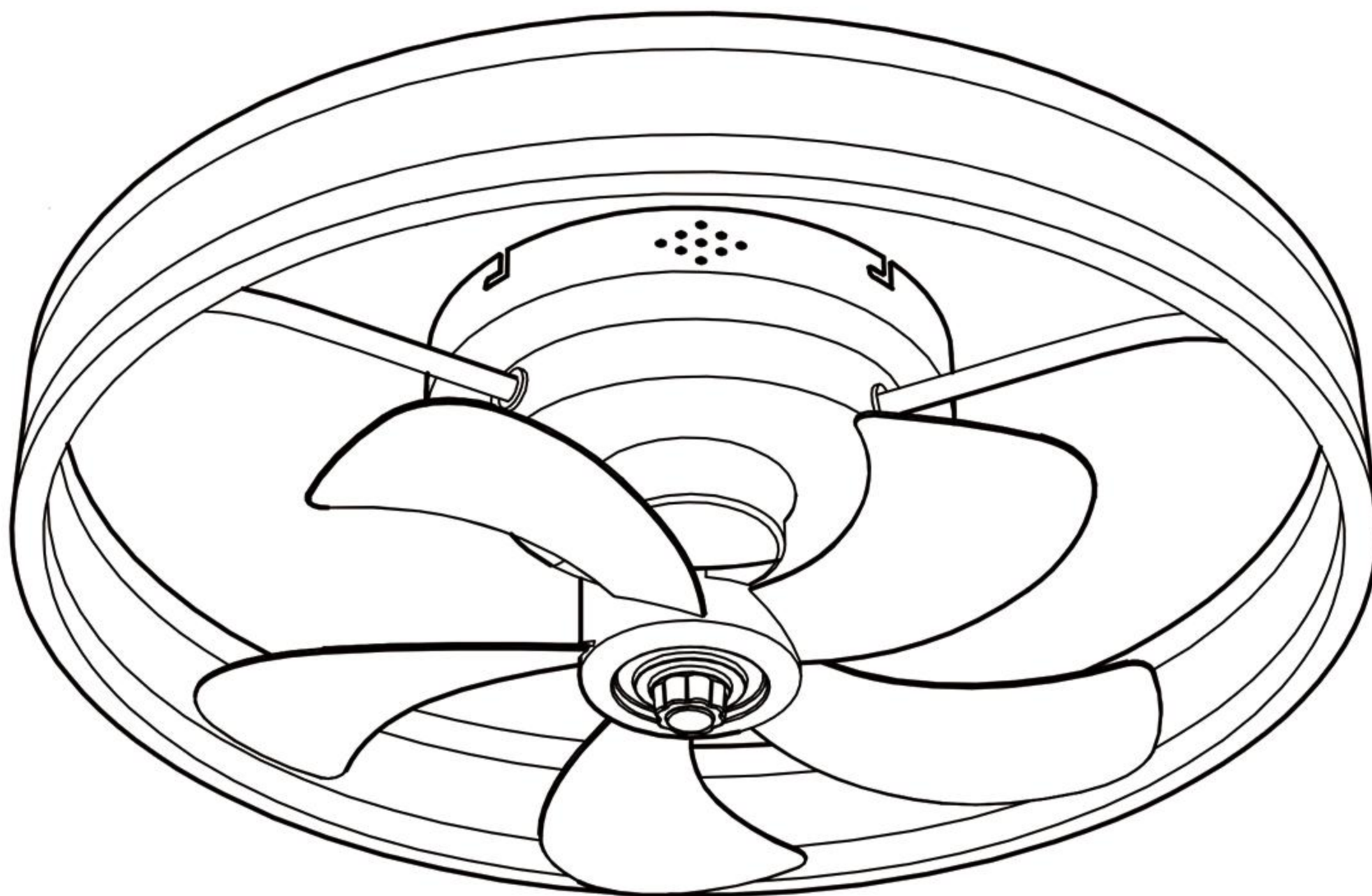

---



Thank you for choosing our fan lights!  
Please be sure to read the manual carefully in order to ensure  
full understanding of installation and use of this product.

# CONTENTS

show >>>

1.Packing list .....	01
2.Install the mounting bracket .....	02
3.Installation step instructions .....	04
4.Wiring instructions .....	04
5.Remote control .....	05
6.Mobile App Control Operation .....	06
7.Care and maintenance .....	07
8.Product warranty and after-sales .....	08

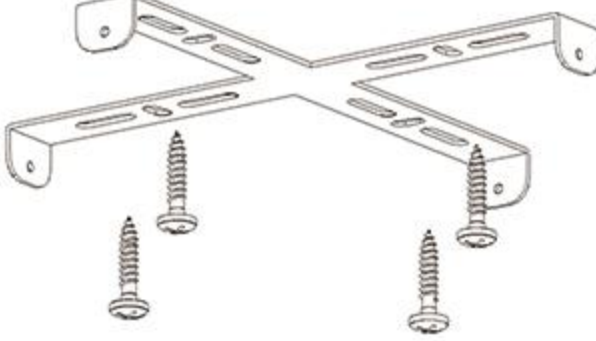
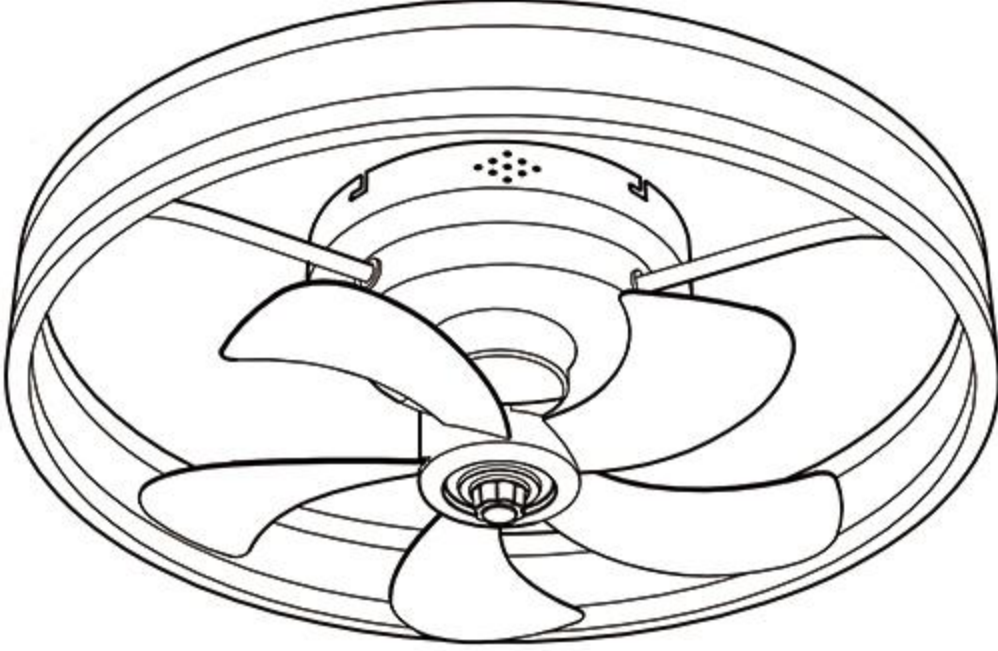
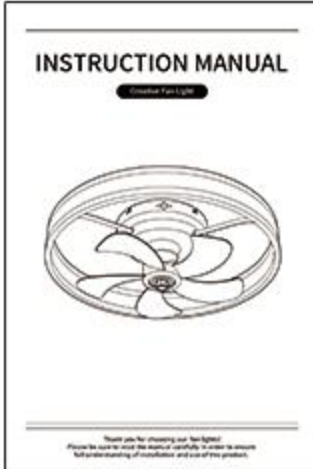
# 1.Packing list

Item	Name	Illustration	Quantity
01	Mounting bracket*1 Self-tapping Screw*4		2
02	Fan lamp body*1		1
03	Instruction Manual*1		1
04	Remote control*1		1

Note:Please make sure everything listed above is included,  
contact us for help if there is anything missing.



Before the installation of the fan light, pay attention to the safety precautions and prepare the tools needed.

1. Turn off the power supply before installation or disassembly of the fan light. If you have a multimeter or voltage tester, it is a good idea to test whether the power is off.
2. The wiring sequence for installation must be ground line, null line(N), live line(L), while for disassembly, it must be live line(L), null line(N) and then ground line to avoid electric shock.
3. Make sure to tighten each screw.
4. When the fan is working, avoid touching the fan blade.

### Installation tools:



Electric drill



Wrench



Ladder



Pincers



Screwdriver



Tape

## 2. Install the mounting bracket

2.1 Take out four screws of accessory package and use them as shown in the illustration

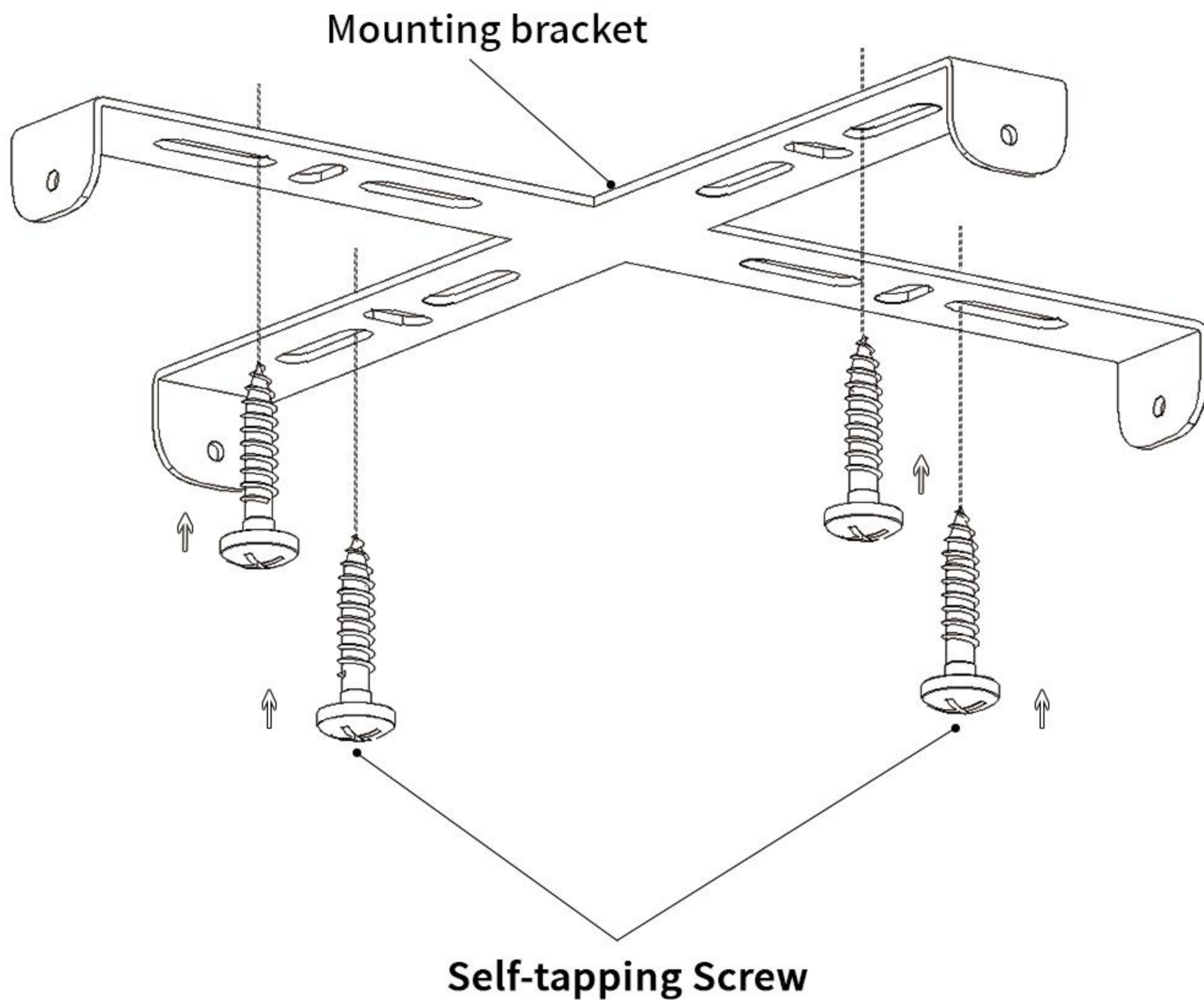

## 2.2 When installing in a wooden ceiling, fix the hanging plate tightly with wooden screws or beams.

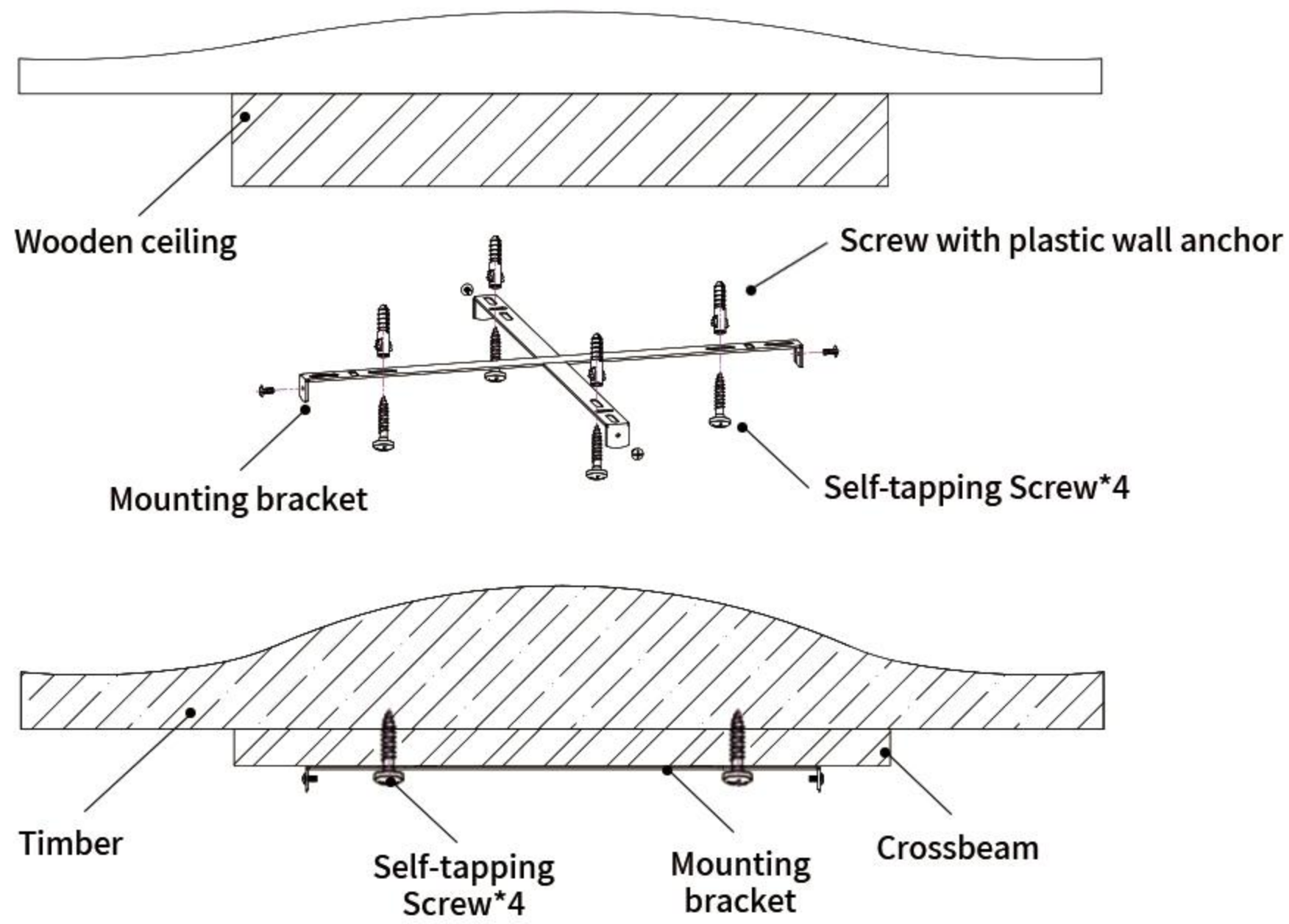

## 2.3 To install on a concrete ceiling, first use an 8mm impact drill to drill to a depth of 50mm, after that use the expansion screws in the accessories package to fix the hanging board on the ceiling.

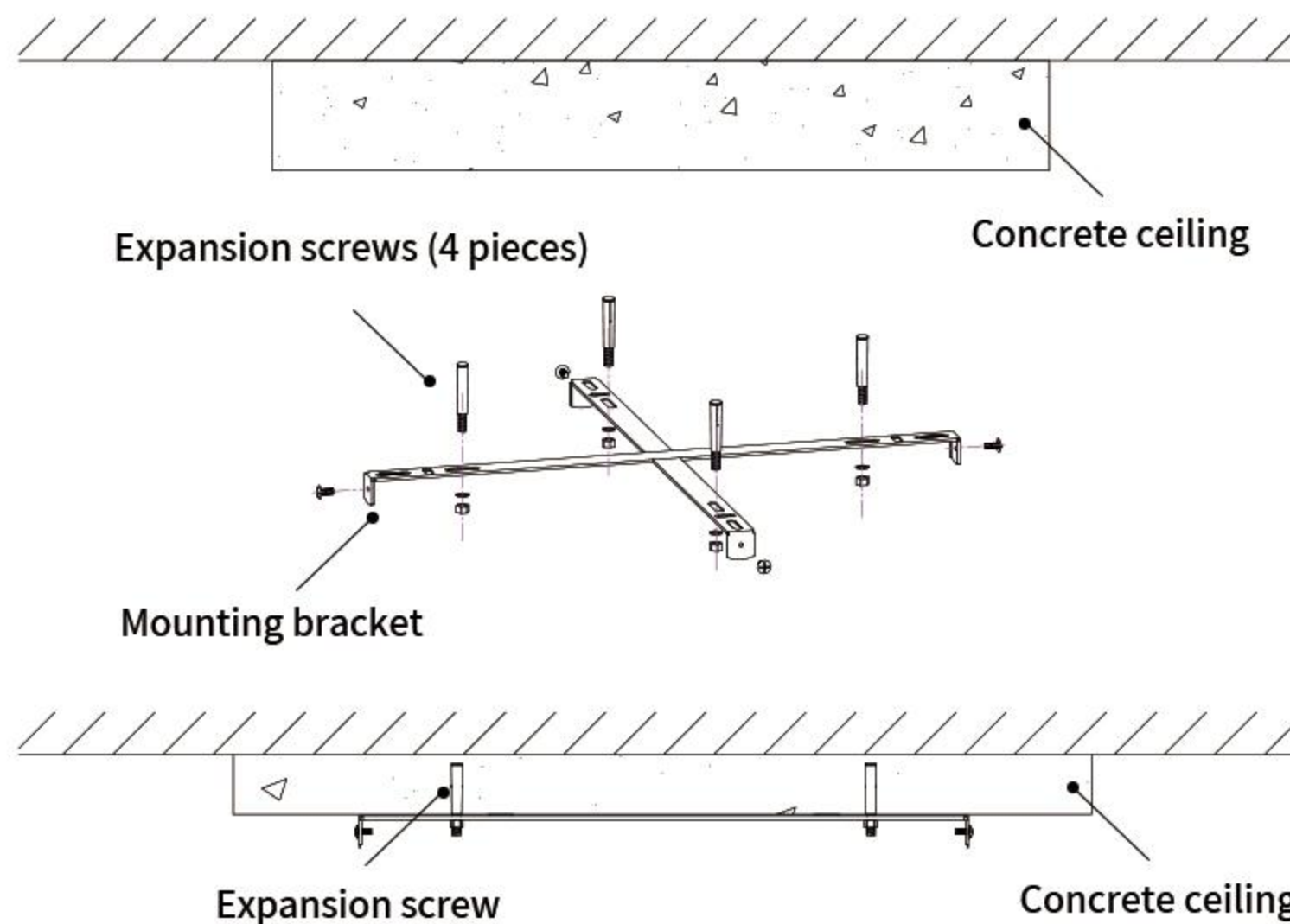

Attention: Please use 8mm diameter drill bit to drill hole first, and then use M6 expansion screws for installation.



### Please note:

1. If you install this product in a wooden ceiling, please ensure that the thickness of the wooden board at the installation position is not less than 30mm and the bearing capacity is not less than 30kg.
2. In order to ensure reliable fixing, when installing on a ceiling made of different materials please use the corresponding fixing screws according to the above instructions.

## 4. Wiring instructions

4.1 Please follow instructions to connect all the power cords to connecting terminal.

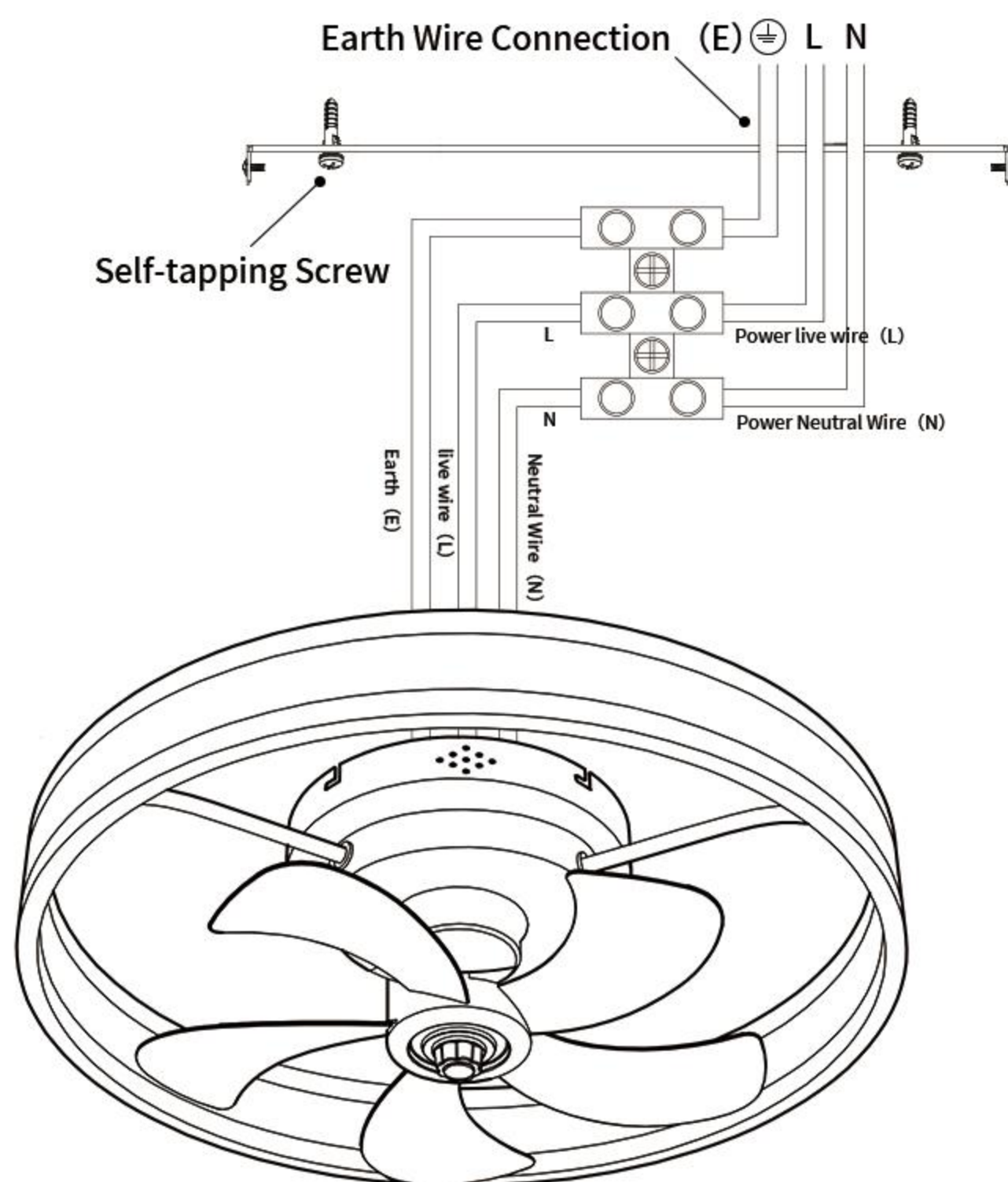

4.2 Please tighten the main part of the fan light and the holder using four screws.

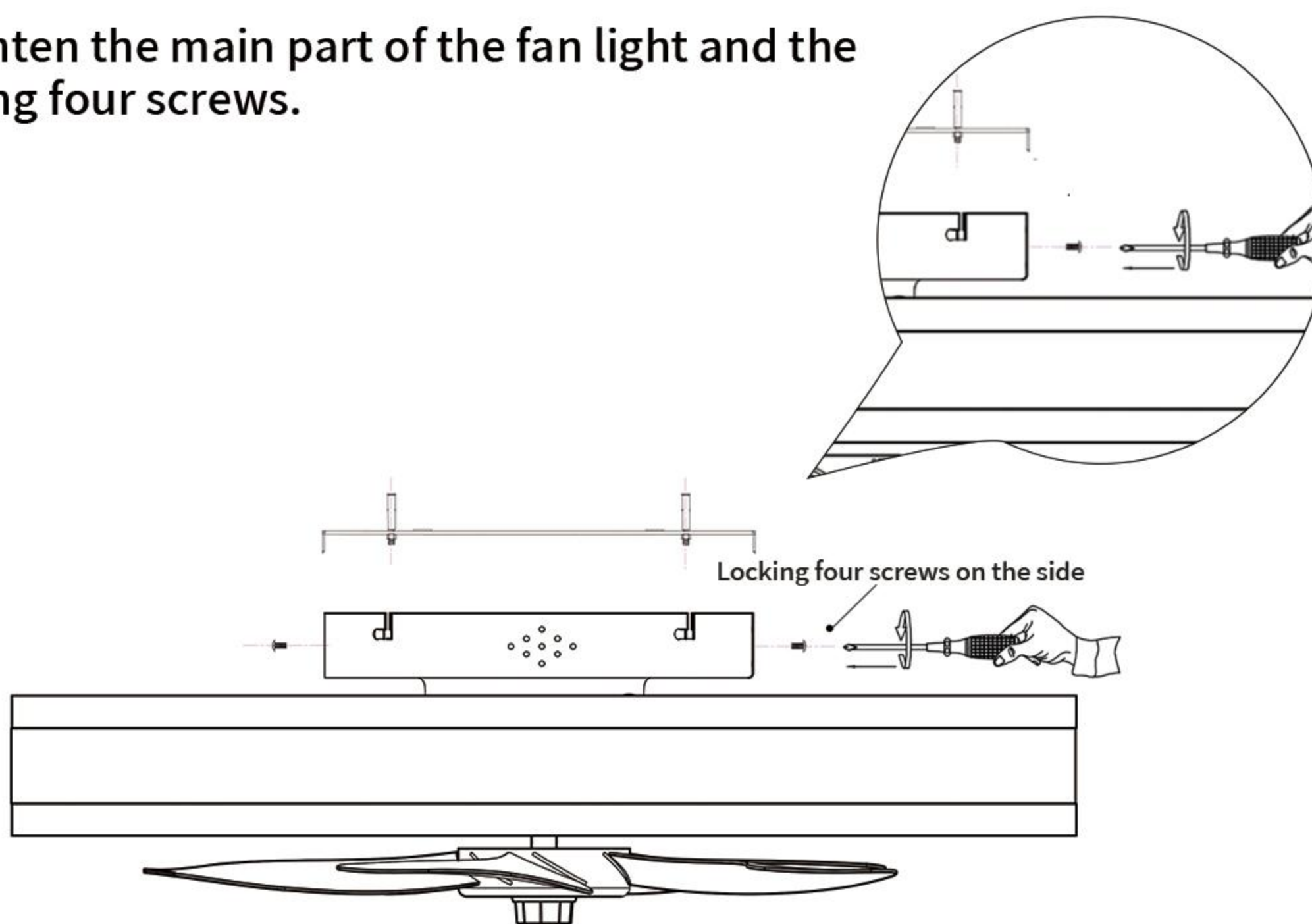

### Attention:



1. Before installation, carefully check the appearance of the fan light. Contact us for help if there is any paridamaged.
2. Make sure the power is off before install ation.
3. Make sure the L lines and N lines are well wired or there would be abnormal light flash.

# 5.Remote control

## 5.1 Introduction to the key functions of the remote control

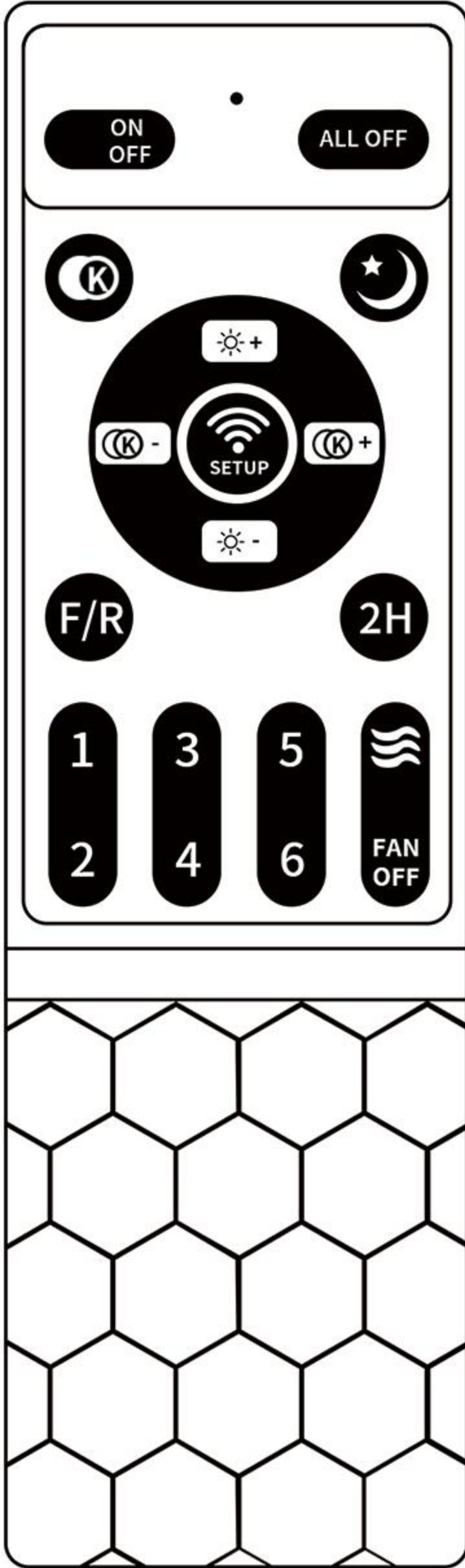

### Description of code matching method

1. Turn on the wall power switch, long press the “SETUP” key for 5 seconds until hearing a “Di” sound. After hearing the sound twice, the match is done successfully.
2. If not matched, turn off the power for one minute and repeat the step mentioned above.
3. If the remote control is not working, change the battery and try again.

- Turn on the light/Turn off the light
- All off
- Change color temperature
- Night lamp
- Increase brightness
- Reduce brightness
- Increase color temperature
- Reduce color temperature
- Forward rotation/ Reverse rotation
- Timing function 2 hours
- Fan speed selection, 1 for minimum, 6 for maximum.
- Natural wind
- Turn off the fan

### Software download: Scan QR code to download



Scan to download  
APP control

1. Download Software: Scan the QR code to download and install the APP. Follow the instructions to register a user account.
2. Add Your Device: After logging the APP, click “+” in the upper right corner to add a device. Fill in the information needed (device name, room and device type) according to the instruction to complete the procedure.
3. Match Code: After adding the device, click the device icon to enter device detail page. Power off your device for 1-2 seconds and then power on again. Click the “matching” button on the bottom right corner, the light would flash for 3 times and the matching is done successfully. You can use the APP to control several devices at the same time.

# 6. Mobile App Control Operation

## 6.1 Easily experience the life of intelligent control



**Step1**  
Turn off the lights first



**Step2**  
Scan the QR code and download the app, works with IOS/Android system

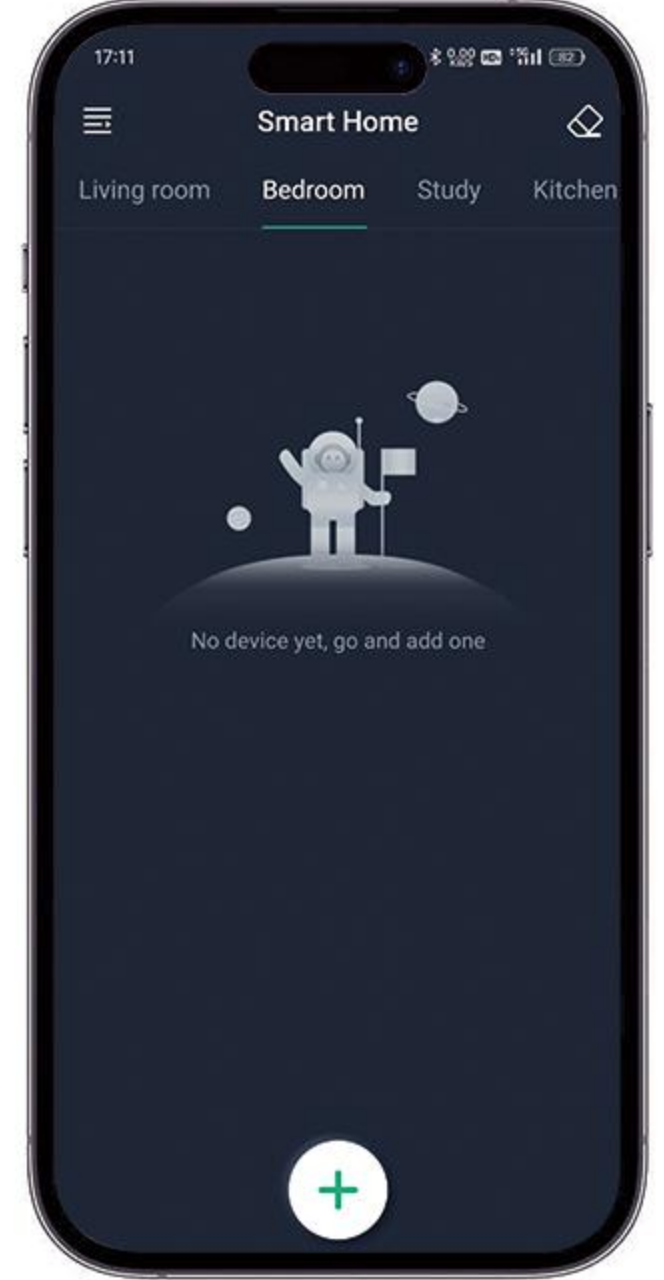

**Step3**  
Click "+" to add device name

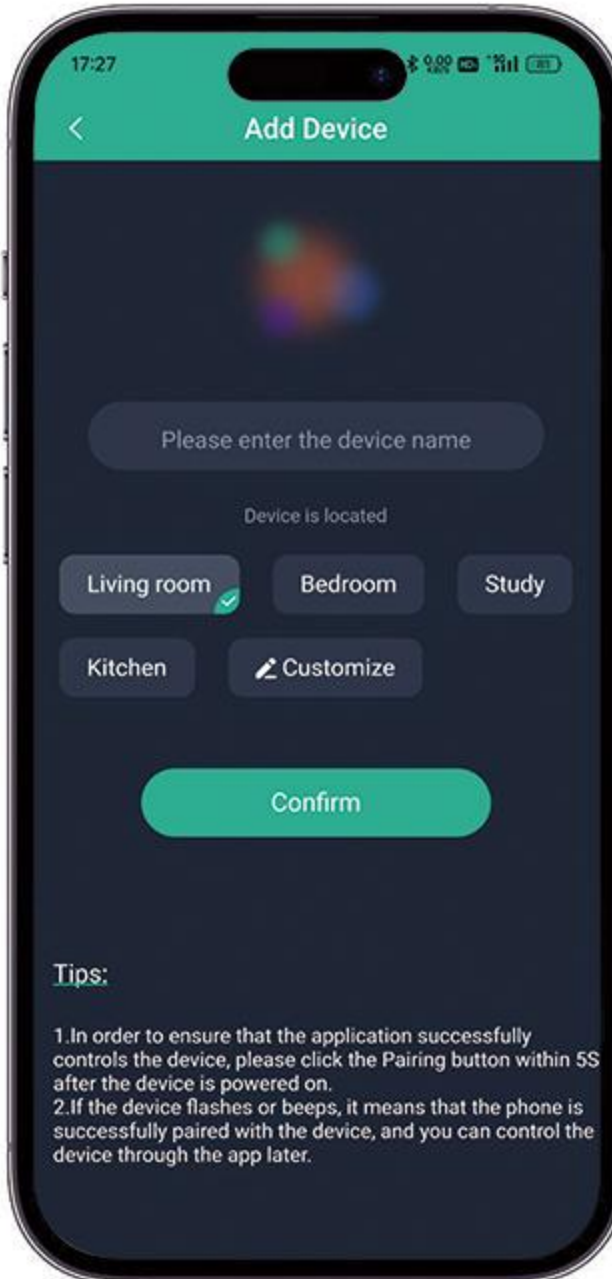

**Step4**  
Control the device classification and set the name of the lamp, for example, name this device "Fan Light" to control the device through the app later.

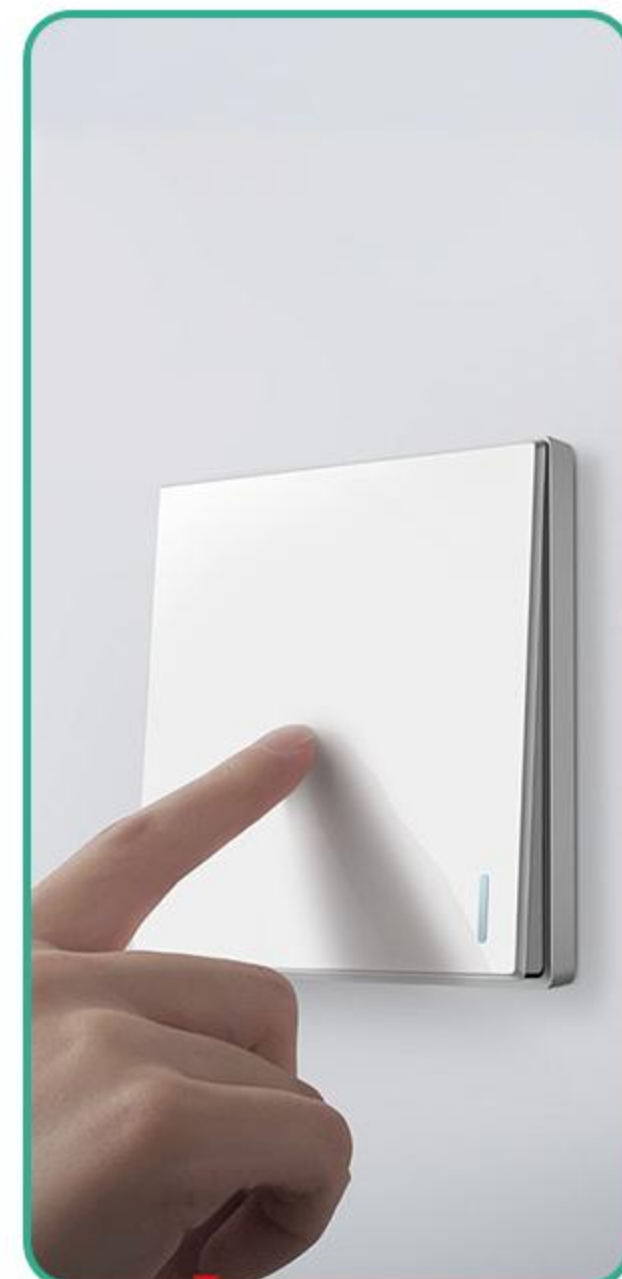

**Step5**  
Turn on the light



**Step6**  
Turn on the matching button. In order to ensure that the application successfully controls the device, please click the "📶" button within 5 seconds of the device being powered on. If the device flashes or beeps, it means that the phone and the device are successfully matched, and the lamp can be controlled through the application later.

# 7. Care and maintenance

---

## 7.1 About product maintenance

1. In order to use this product safely and efficiently, please clean the dust of the fan lamp once a year. For the removal method, please refer to the previous installation steps. If conditions permit, butter can also be applied to each rotating part of the motor to reduce the abnormal noise caused by the friction of the parts.

## 7.2 Questions and answers encountered during use

### Q1: What should I do if the fan light does not start normally?

A: Check the power supply to see whether there is short circuit or the voltage is lower than required (AC220V±10%). And if no problem with power supply, check if the fan light is well connected.

### Q2: The fan light does not respond when using the remote control for the first time?

A: Make sure the fan light is well connected and the power is on. And check the battery of the remote control. If everything alright, try to repeat the matching process. Just contact us if any help needed.

### Q3: There is a sound but the remote control does not work normally?

A: Please check the wiring of the fan light, see if they are well connected. Make sure you turn off the power supply when checking.

### Q4: The fan light is normal, but the fan is running but there is no wind, what's the matter?

A: Most probably is that you have pressed the reverse rotation button, just press again to get back to forward rotation.

### Q5: When turning on the wall control switch the light flashed but did not light up, and there was no response when pressing the remote control?

A: Check whether all the connection is normal, if there is still no response, there may be a problem with the controller, you can contact our customer service staff to replace the controller.

### Q6: What should I do if the fan light makes noise?

A: 1. Check if the wires at the back of the fan light are close to the motor, adjust if yes.  
2. Make sure that the fan light is not damaged before installation.  
3. Check if the fan light is installed firmly.  
4. Installation on a wooden suspended ceiling, steel structures or prefabricated panels are not recommended because they would amplify the sound.

Note: if the problem still persists after the above inspection, please contact the professional maintenance personnel of electrical appliances or call the dealer for maintenance.



### Warning:

In order to prevent fire and electric shock accidents, please use electrical switches and wires that meet national safety standards, please turn off the power supply during maintenance or cleaning to avoid personal injury accidents!

## 8. Product warranty and after-sales

### Product after-sales guarantee card

Customer Name	
contact number	
contact address	
Product number	
Purchase store	
store contact	
Purchase time	

★The voucher must be stamped by the company's authorized dealer to be valid.  
If there is no voucher, you only need to provide a complete and valid online transaction record to get the warranty.

