

Owner Manual

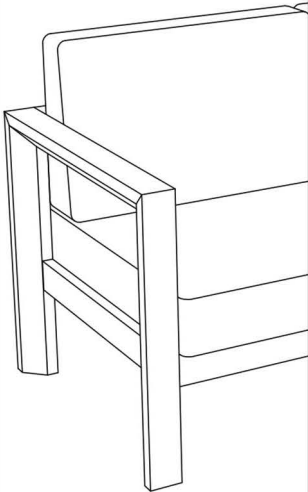

WARRANTY

We strive to offer high quality product and we also try our best to satisfy each customer that order from us, no matter on products or services as needed. Each customer receives a record of their order, such as the order number or item receipt. For any items that are out of warranty period, you may still be able to purchase the replacement parts from our company if they are available.



MAINTENANCE AND WARNING

Please read the manual thoroughly
before you start installing.

Please keep the product away from
sharp object.

Packaging and small parts may have
chocking hazard, please keep them away
from children and pets.

Please clean the product according to each
clean code, check the product description
for more information.

Please keep the product away from
fire.

If you have any other questions, please
contact us, we will be glad to help you out.

If the product is placed under direct
sunlight, the pattern or color might fade
away overtime.

Check the product periodically to make
sure everything is secured and tightened.

Always use proper tools for installation.

Do not jump on the product.

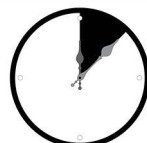

Around 25 min

PRODUCT DESCRIPTION

Outdoor solid wood patio set, includes various seating, side table and coffee table. Features a square geometric cut design with clean, sharp lines. The overall look is simple, offering a modern architectural feel that elevates the style of patios and decks.

Thickened high-density foam filling. The seat and back cushions are plump and substantial, offering excellent resilience and sinking comfort for prolonged, relaxed seating.

Modular design: single chair/loveseat + coffee table/side table, four modules are able to arrange by your needs or like.

Water-resistance cotton-blend fabric. Offers good water and stain resistance, protecting against common outdoor splashes and dampness. Easy to maintain with a simple wipe.

Heavy frame made of natural solid teak wood. High density and natural oils provide inherent rot resistance, insect resistance, and exceptional stability. The robust frame and joinery ensure superior load-bearing capacity and long-term durability.

EXPLODED VIEW

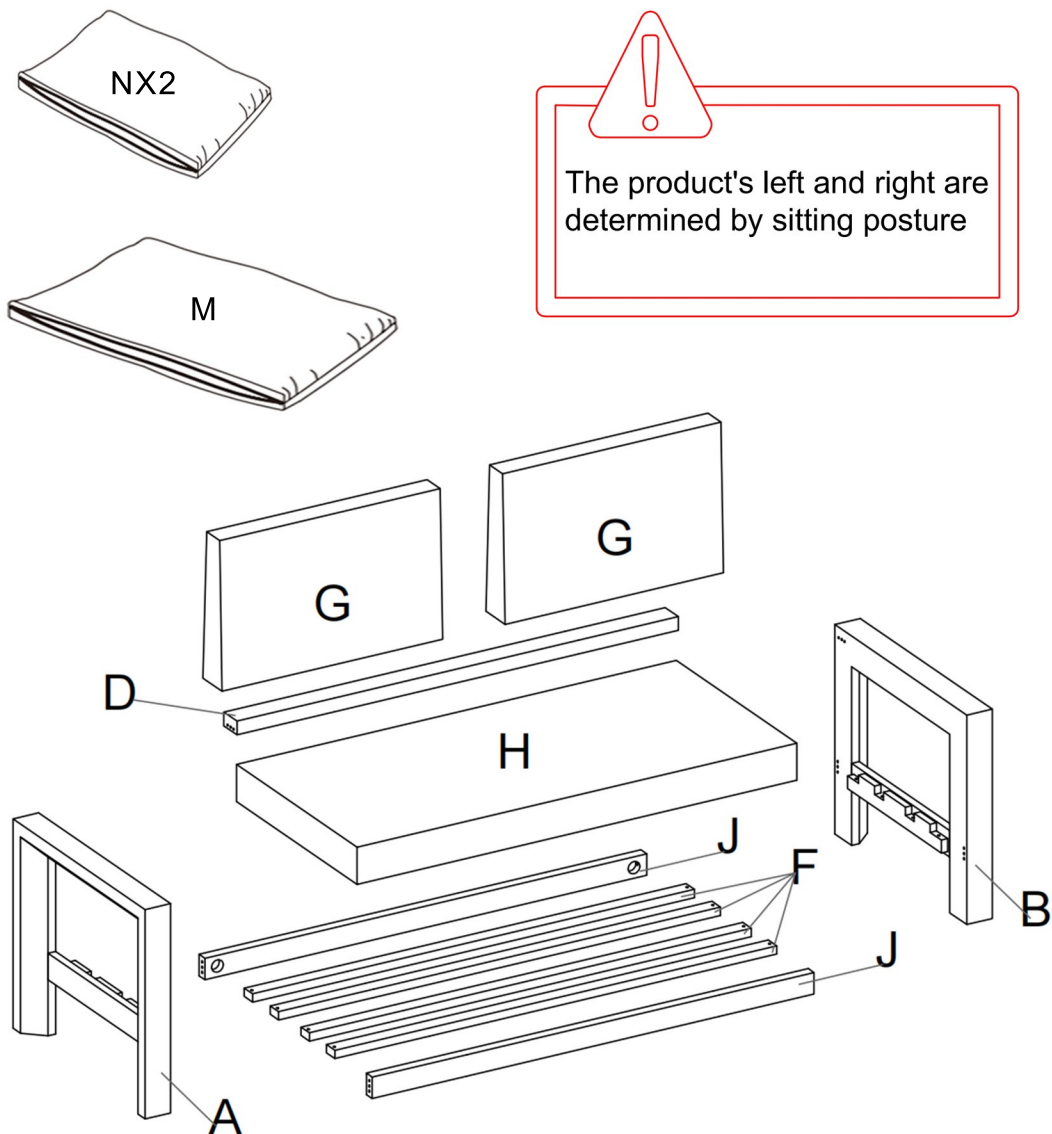

PARTS

A*1

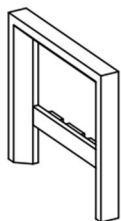

Right armrest

B*1

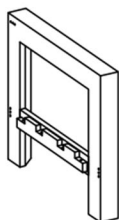

Left armrest

D*1

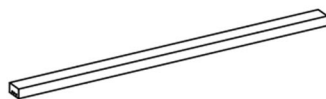

Rear Top Frame

F*4



Seat Frame Bar

G*2

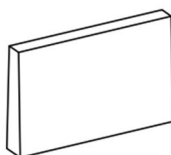

Back cushion

H*1

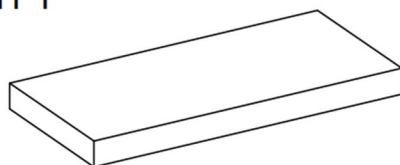

Seat cushion

J*2



Front Panel/
Back panel

Ox1

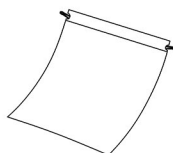

Bag

Mx1



Seat cushion cover
(Hide in bag)

Nx2



Backrest cover
(Hide in bag)

★The Cover with the washing label is the Backrest Cover

HARDWARE

TOOL LIST

NOTE: Designated with (★) We provide additional spare parts in the hardware package

①x8



★ Bolt
M6*35mm

②x8



★ Flat washer

③x12



★ Wooden dowel

④x6



★ Nut

⑤x6



★ Half-moon nut

⑥x6



★ Bolt
M8*70mm

⑦x1

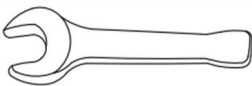

Spanner

⑧x1

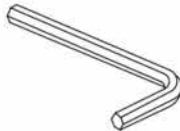

Allen key

Please make sure all hardware & packing material fitting the list. Especially some small accessories may be missing during transportation. Please contact us if you have any question.

step 1 ---Cut the plastic air compression bags

Cut the plastic air compression bags, and take out the cushion (G). Let it recover to its original shape, the whole recovery process might take **72** hours, you may gently slap on it to speed up the process.

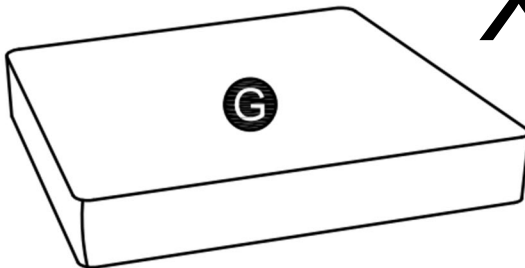
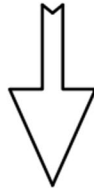
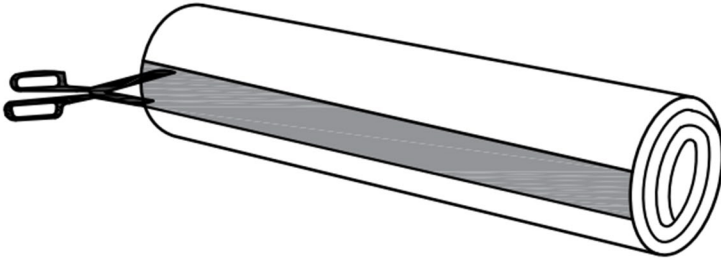
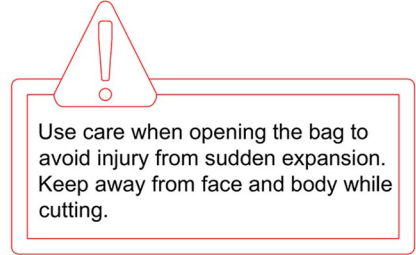
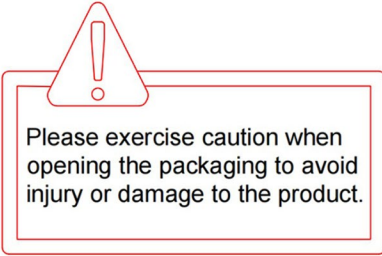

X2

step 2 ---Cut the plastic air compression bags

Cut the plastic air compression bags, and take out cushions (H). Place them on the side for recover to their original shape, the whole process might take up to **48** hours, you may gently slap on them to speed up the process.

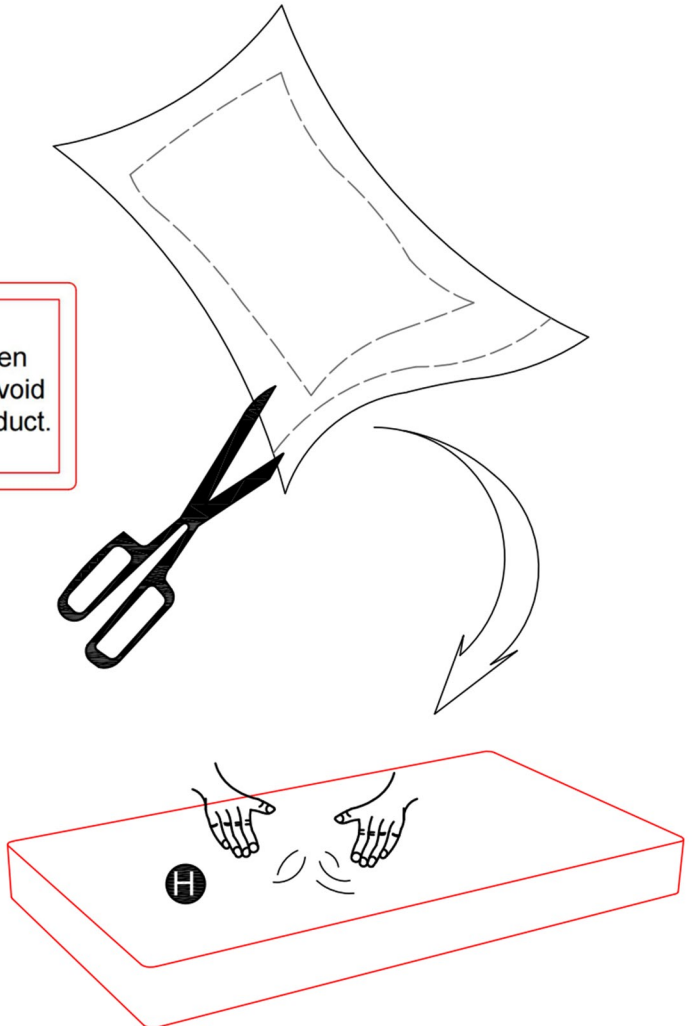
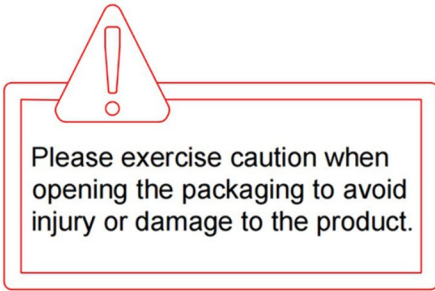

step 3 ---Take out the cushion cover

Open the bag, take out the back cushion cover (N) and seat cushion cover (M).

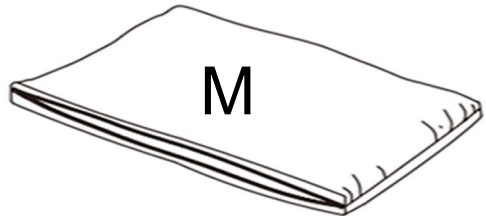
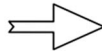
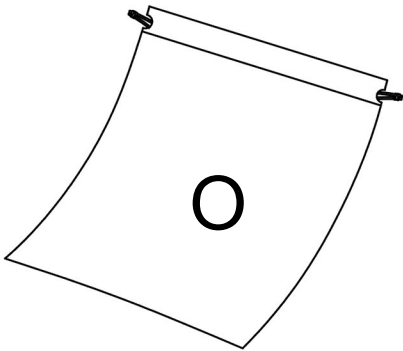
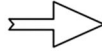
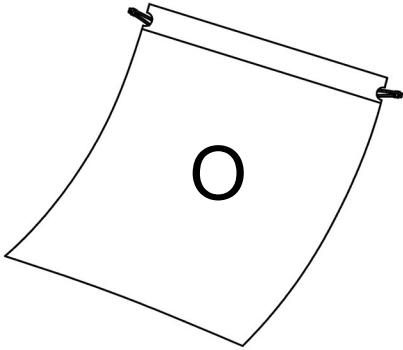

step 4---Put on the cushion cover

How to Put on the Cushion Cover

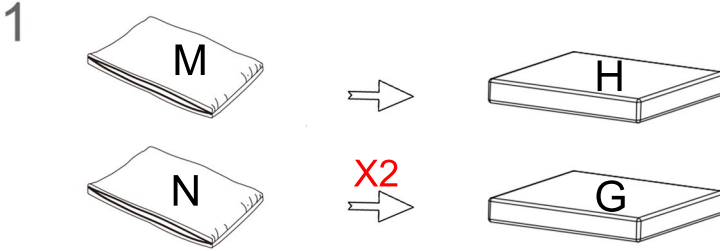

1.Take the cushion covers and inner inserts out of the carton.

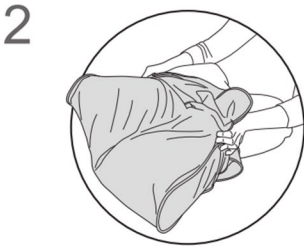

2.Fold the inner in half, pushing the sides together,then begin to slide the cover onto it.

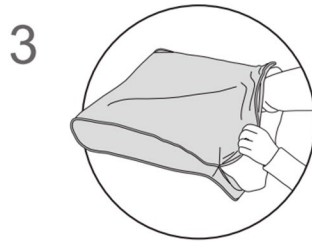

3.Align both far corners, then gently compress insert while fitting cover around it.

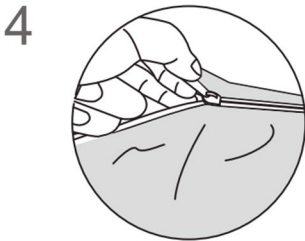

4.To avoid a stuck zipper, please pull the fabric away from the zipper before moving forward.

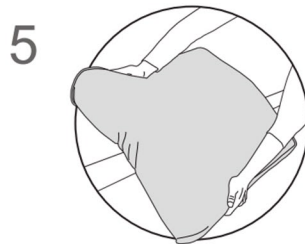

5.When all done, please pat the cushion or give it a little shake to make it more flat.

step 5 ---Insert Fasteners into Armrest

Insert the threaded bolts and wood dowels into the pre-drilled holes on one armrest, as illustrated.

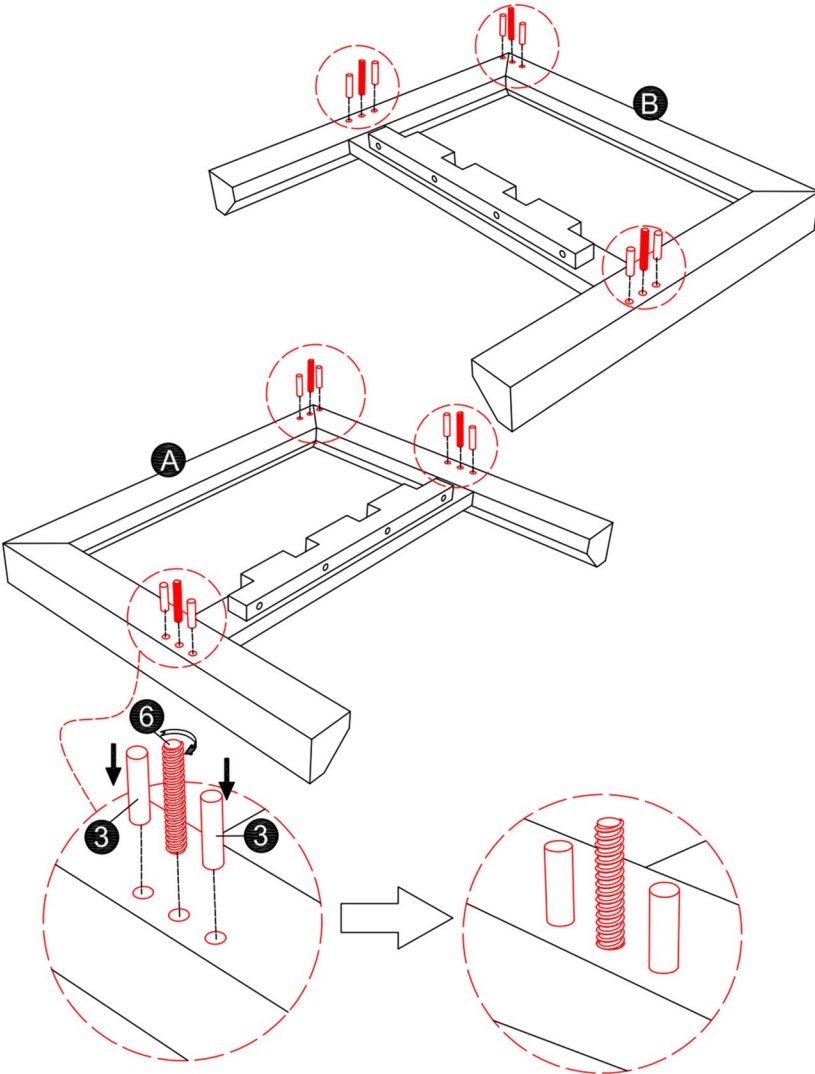

step 6 ---Attach the Frame

First, place the rear top frame and the front/back panels onto the installed bolts and dowels. Then, secure the threaded bolts by tightening the half-moon nuts and bolt nuts.

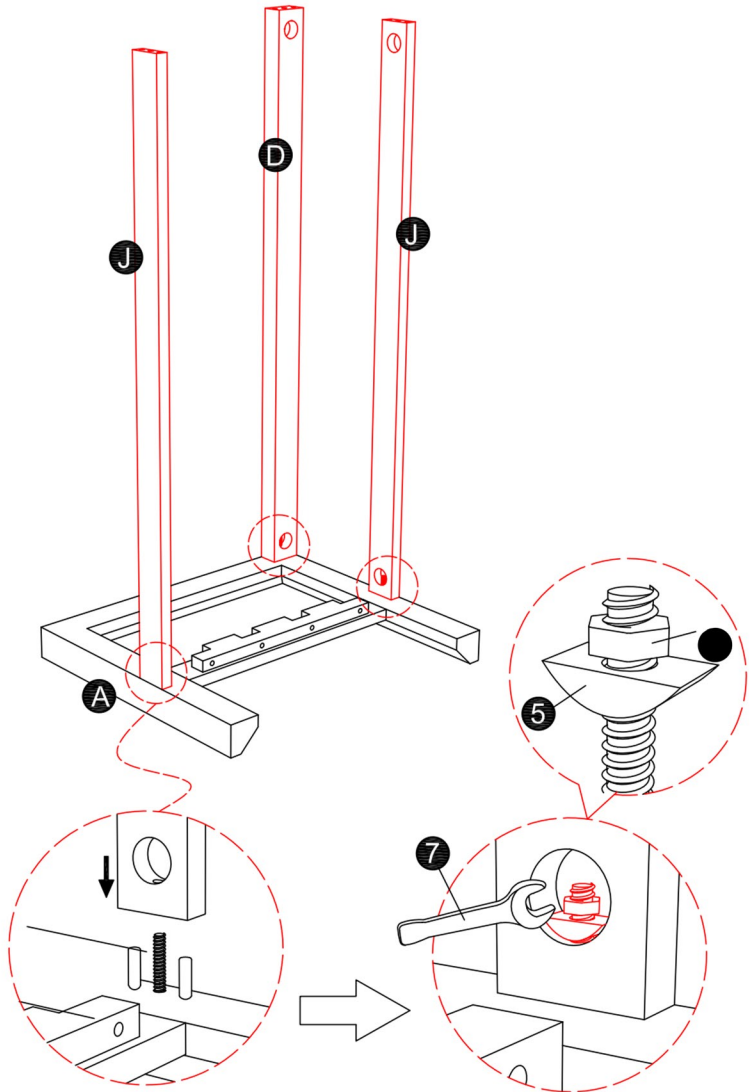

step 7 --- Attach the Other Armrest

Align the second armrest with the exposed bolts and dowels on the opposite side of the frame. Ensure all fasteners are correctly positioned, then secure them by tightening the half-moon nuts and bolt nuts as shown.

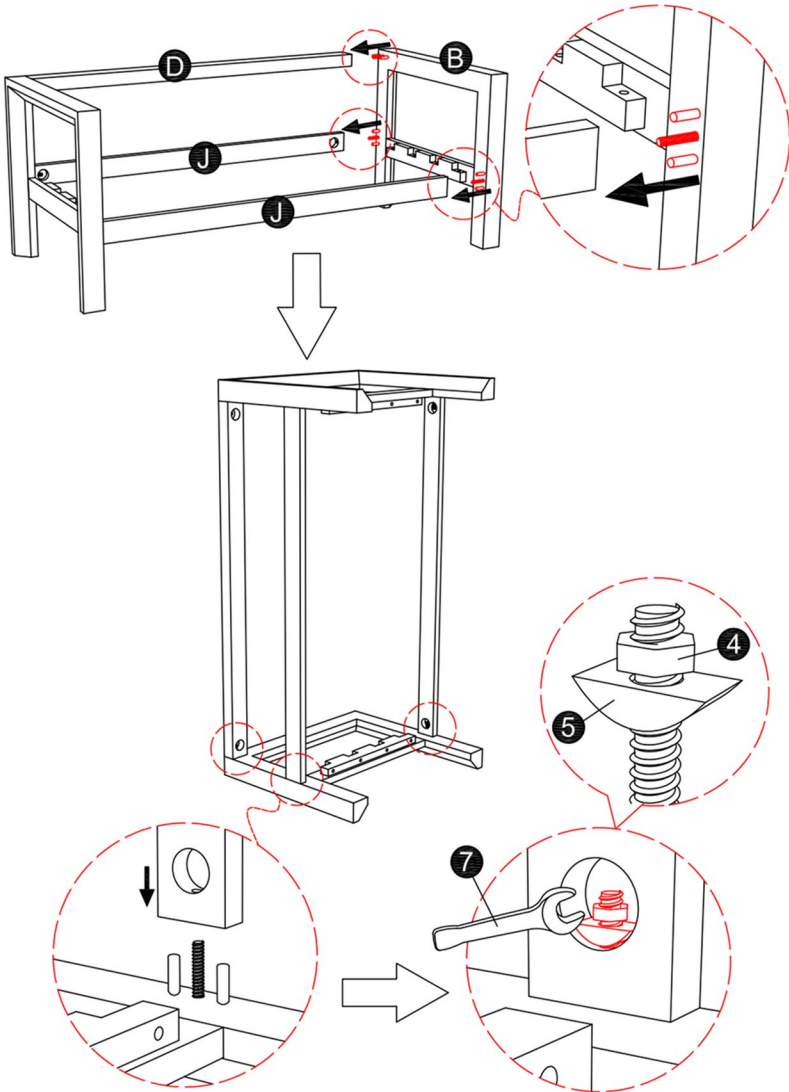

step 8 ---Install the Seat Frame Bars (F)

Align the Seat Frame Bars (F) with the designated grooves on both the Left and Right Arms (B&A), as shown. Place one washer (2) on each bolt (1), then use the provided allen wrench (8) to tighten all bolts.

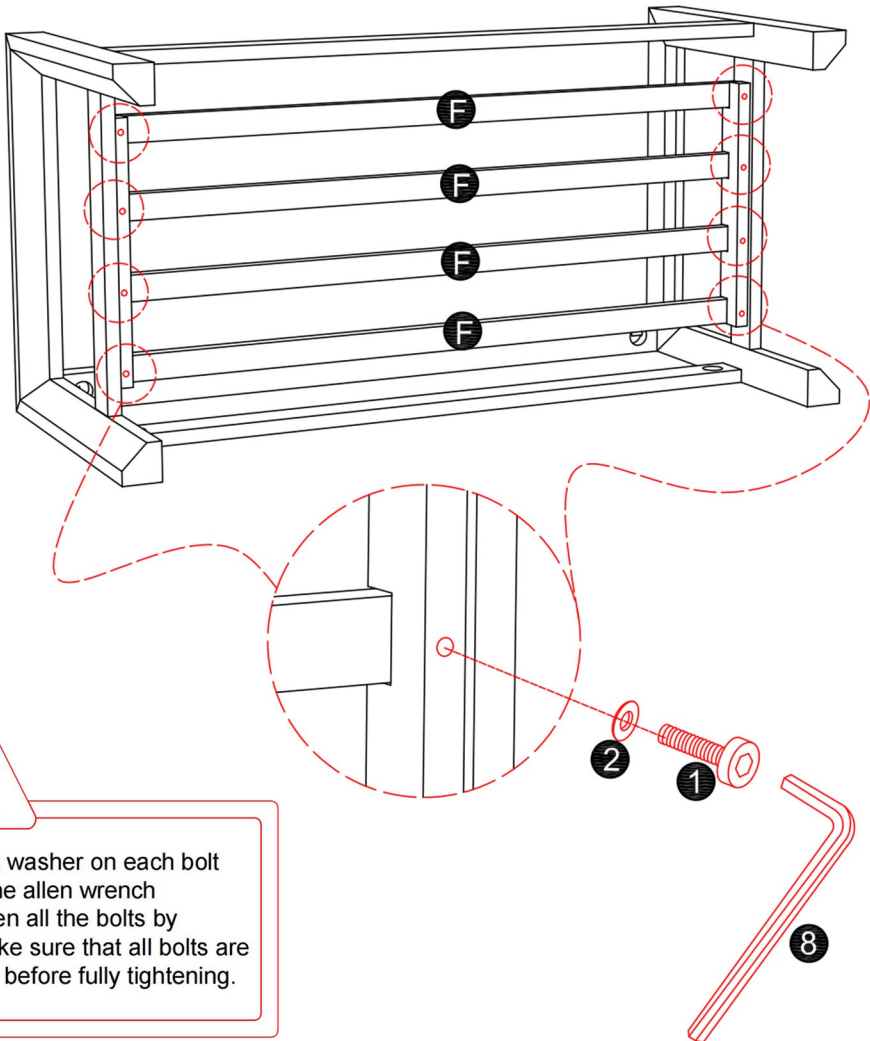

First add one flat washer on each bolt as shown, use the allen wrench provided to tighten all the bolts by 30-50% first, make sure that all bolts are aligned correctly before fully tightening.

step 9 ---Place the seat cushion (H) and back

Turn the Back cushion & Seat cushion with the labeled side facing up.

1. Place the Seat cushion(H) on it.
2. Place the Back cushion(G) on it.

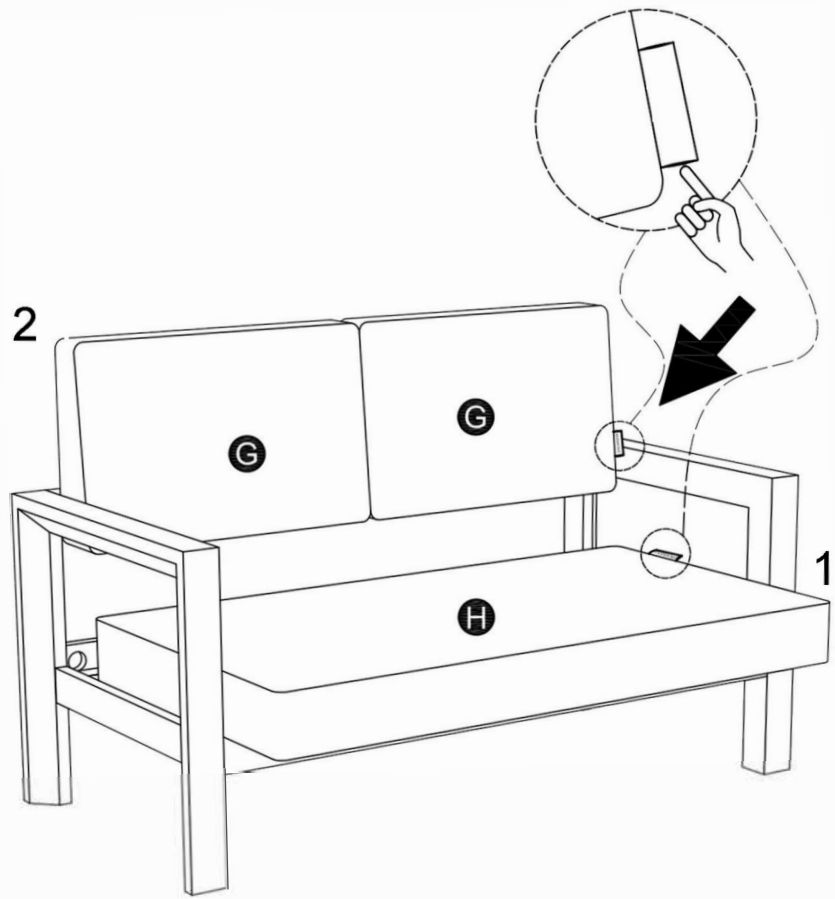

step 10 ---Assemble complete

Congratulations! You have finished the assembly, thank you again for choosing our product! Please enjoy!

